

EH Miniature Lighted Pushbutton Switch

Only 22.5mm depth behind panel with built-in resistor

Bright and Variable Illumination makes easy planning of multiple design.

■FEATURES

- Depth behind panel : Only 22.5mm
- LED Full-Face, Split-Face, Dual-Color, Spot and Lamp Illumination available.
- Hi-Bright LED Super Blue, Super White, Super Green added to Red, Green, Yellow.
- Built-in resistor for 5V,12V,24V use.
- Light Cartridge is removable from front panel.
- Button Size : 14.2mm square type, 14.2×20.4mm rectangular type
- Precision-snap action switch movement with coil spring assures long life and outstanding tactile feedback.
- Silver Contact(Gold-Plated) and W/E Alloy #1 Cross-bar Contact provided.
- Accessories: Barriers, Guard Covers, Sockets, etc.

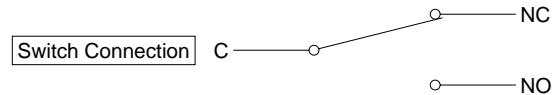
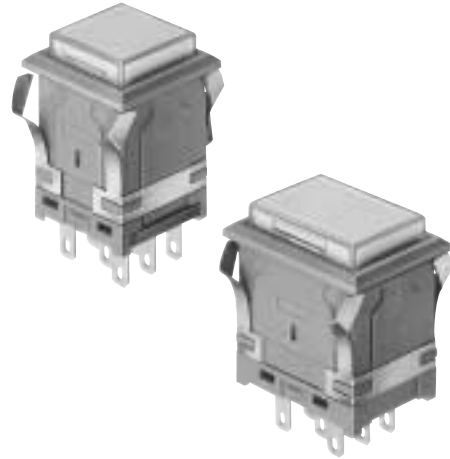

SPECIFICATIONS

Contact	Silver Contact (Gold-Plated)	W/E Alloy #1 Cross-bar Contact
Electrical Rating	AC125V,250V 3A(Resistive)	AC125V 0.1A, DC30V 0.1A(Resistive)
Insulation Resistance	More than 100MΩ at 500V DC	
Dielectric Strength	1000V AC RMS between NC and NO terminal 1500V AC RMS between terminals and ground 50/60Hz for 60sec. at normal ambient temperature and humidity	600V AC RMS between NC and NO terminal 1500V AC RMS between terminals and ground 50/60Hz for 60sec. at normal ambient temperature and humidity
Contact Resistance	Less than 30mΩ (Initial) at DC6V 1A	Less than 50mΩ (Initial) at DC6V 0.1A
Mechanical Life	Momentary Action :more than 2,000,000 operations	Alternate Action : more than 200,000 operations
Electrical Life	More than 100,000 operations at max. rated load	
Ambient Temperature	-15°C to +50°C	
Ambient Humidity	80% RH (max.)	

OPERATING CHARACTERISTICS

Operating Force (max.)	4.41N	Total Travel (max.)	3mm
------------------------	-------	---------------------	-----

STRUCTURE

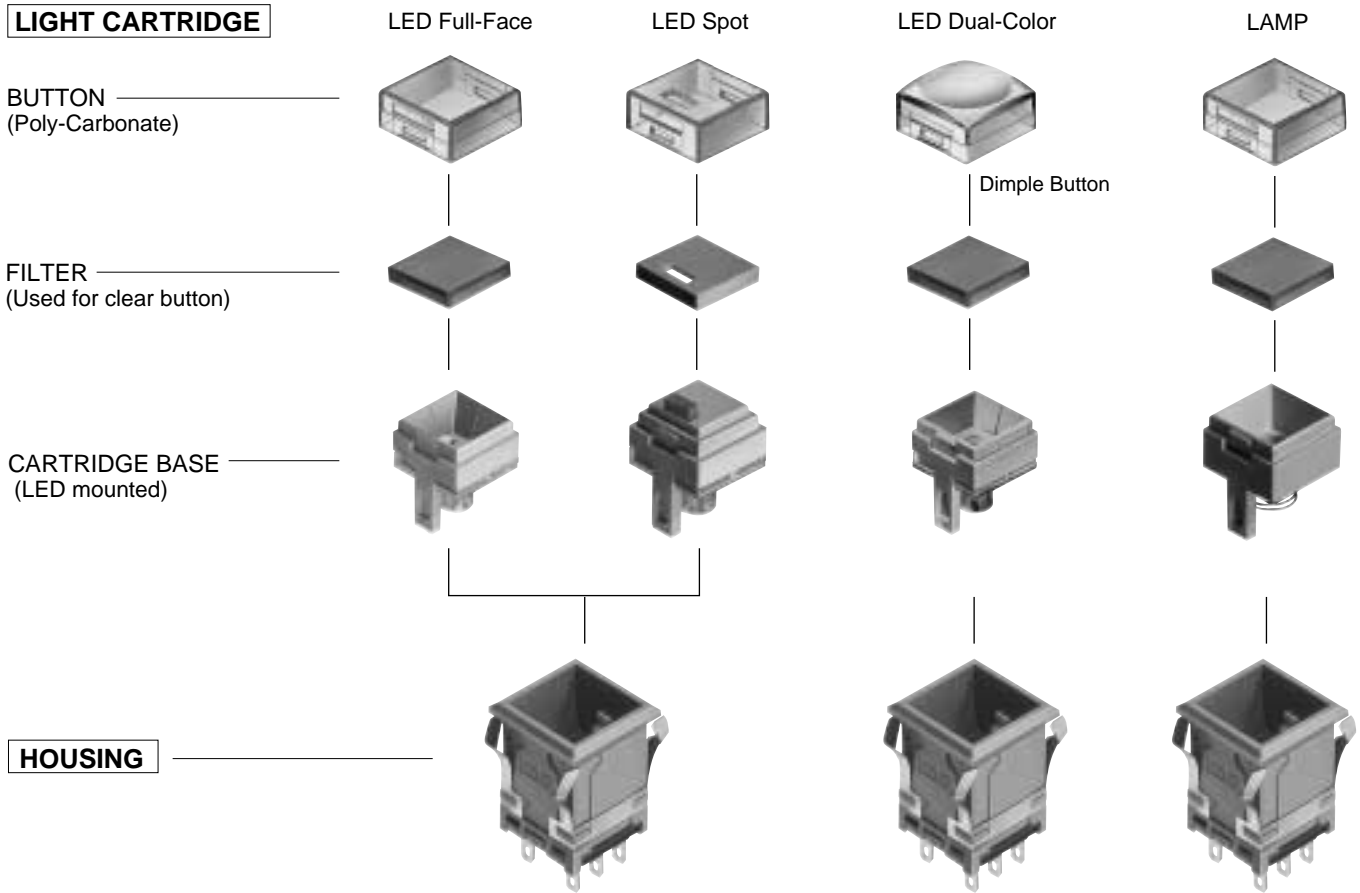

DIMENSIONS

14.2mm Square Button Full-Face		 	 Top View *3.9 for Dimple Button
14.2mm Square Button Spot		 	 Top View

Tolerance : ±0.4mm

DIMENSIONS

14.2×20.4mm Rect. Button(Full-Face)			<p style="text-align: center;">Top View</p> <p style="text-align: center;">*3.9 for Dimple Button</p>
14.2×20.4mm Rect. Button(Spot)			<p style="text-align: center;">Top View</p>

INTERNAL CONNECTION ARRANGEMENTS

● LED (Red, Green, Yellow)

		Full-Face	Dual-Color	Split-Face
LED Full-Face (Square)	5V	BOTTOM VIEW TOP VIEW 	 	
	12V	 	 	
	24V	 	 	 <p style="text-align: center;">*Cannot apply built-in resistor type for 24V</p>

Tolerance : ±0.4mm

INTERNAL CONNECTION ARRANGEMENTS

● LED (Red, Green, Yellow)

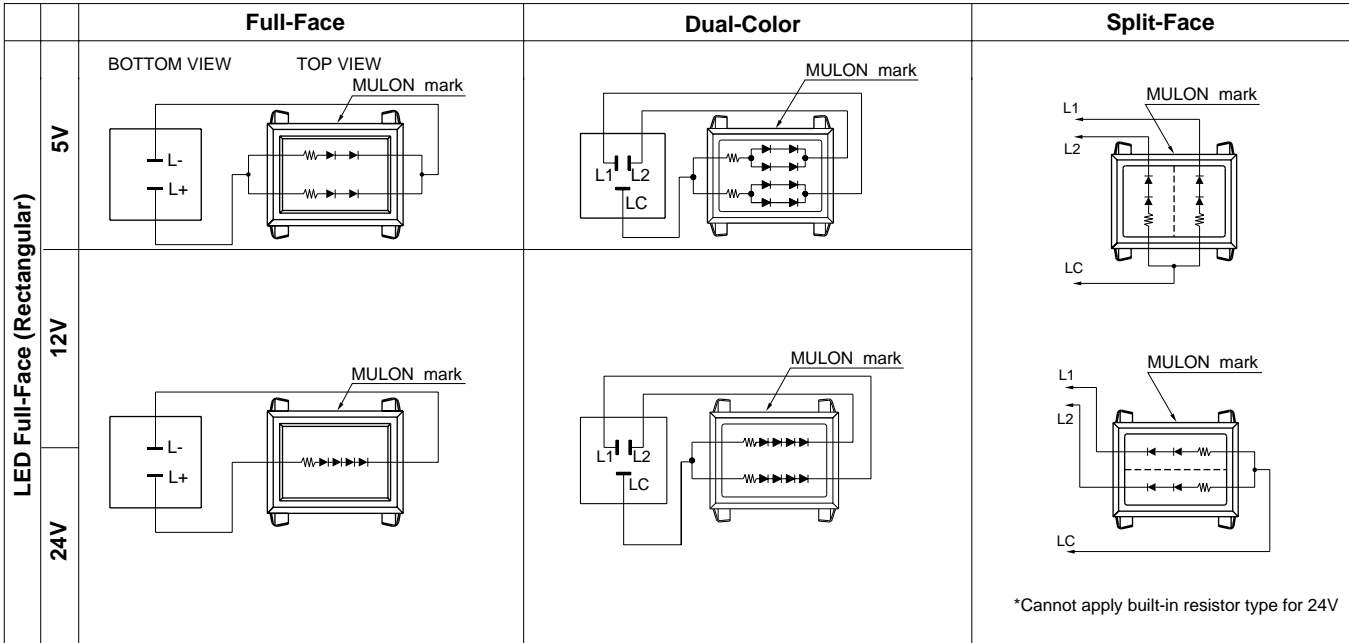

※Please inquire when cathode common type needed.

● Dual-Color Combination

LC(+) - L1	Red	Green	Yellow
LC(+) - L2	Green	Yellow	Red

● Hi-Bright LED (Super Blue, Super White, Super Green)

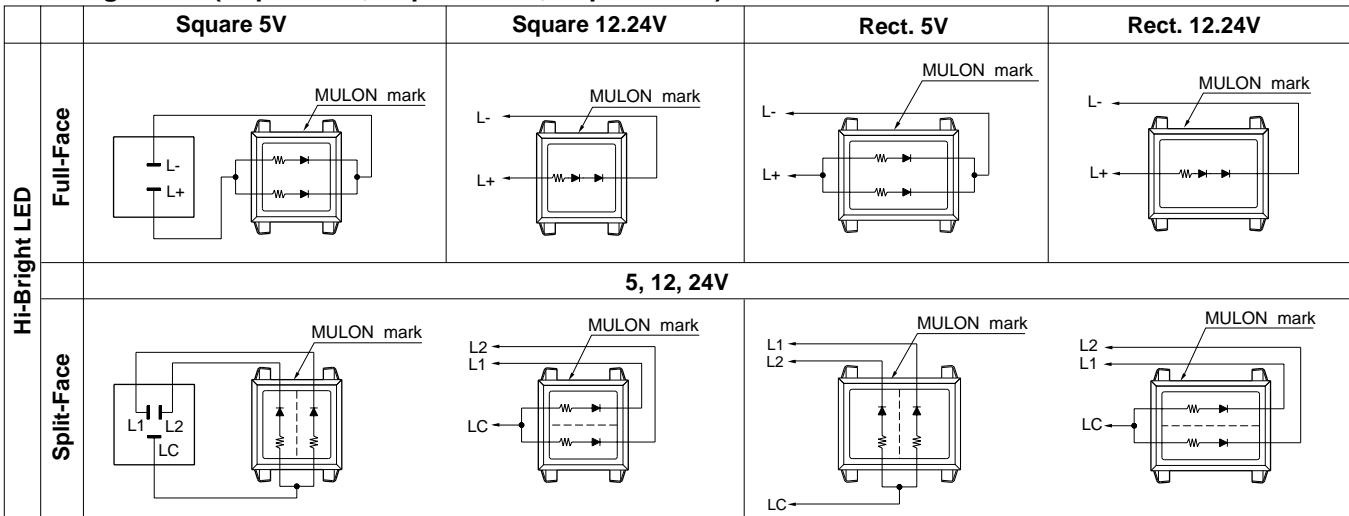

● LED Spot (Square, Rectangular)

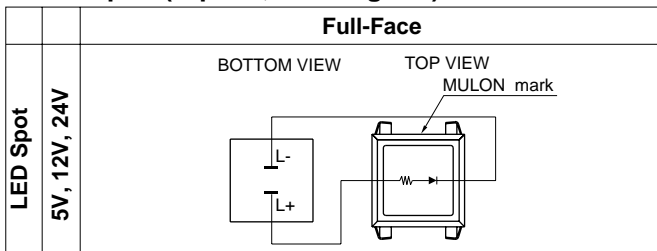

● LAMP (Square, Rectangular)

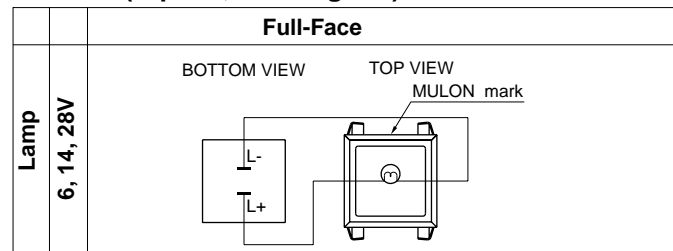

TERMINALS

● TERMINALS LAYOUT (Square, Rectangular)

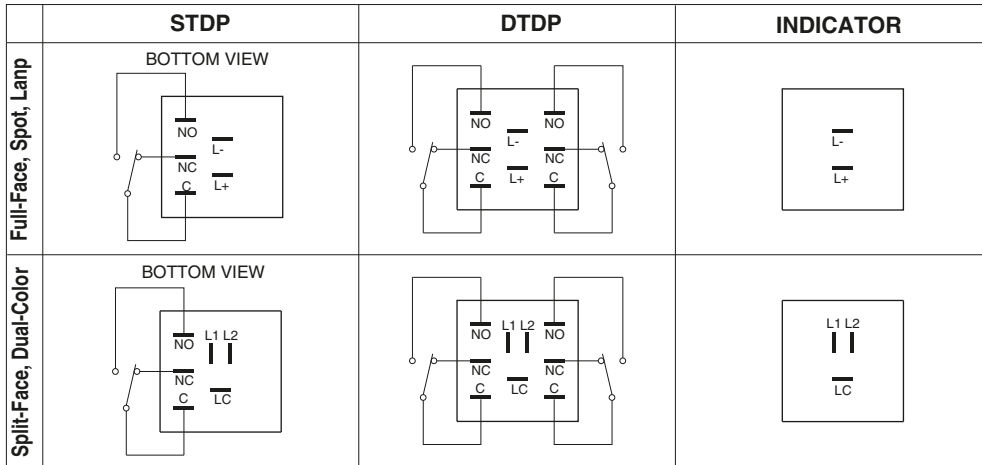

● TERMINALS DIMENSIONS (BOTTOM VIEW)

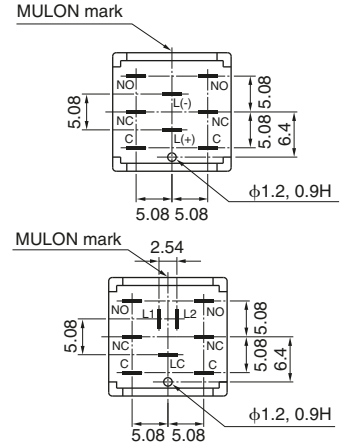

TERMINAL SHAPE

● TERMINAL SHAPE

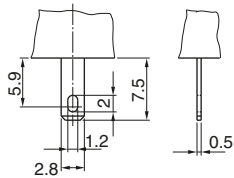

#110 TAB Soldering Terminal

LED DATA

※ Red=R, Yellow=Y, Green=G, Super Blue=SB, Super White=SW, Super Green=SG

● LED RATINGS

	Full-face		Dual-Color		Split-Face			Hi-Bright Full-face		Split-Face		Spot		
	Current Rating (mA)											Current Rating (mA)		
DC Supply Voltage (V)	R	G	Y	R	G	Y	R	G	Y	SB, SW	SG	R	G	Y
5(±5%)	30			15			32		16		R	5		
12(±5%)	15						16		8		R	5		
24(±5%)	9			Nil			8				R	5		
											G	20		
											Y	10		
											R	5		
											G	20		
											Y	10		

● EXTERNAL RESISTOR

Switches are normally fitted with internal resistors to operate on 5,12,24V DC supply. In case of non-resistor type, suitable external current limiting resistors must be installed as shown by the table and formula.

ITEM	Full-Face Dual-Color		Split-Face	Hi-Bright				Hi-Bright Split-Face		Hi-Bright Dual-Color			Spot					
	DC5V		DC5V,12V,24V	DC5V		DC12V,24V		DC5V,12V,24V		DC5V			DC12V,24V					
	R,G,Y	R,G,Y	R,G,Y	BW	G	SB,SW	SG	SB,SW	SG	SB	SW	SG	SB	SW	SG	R	G	Y
Max. operating current IFM (mA)	40	20	20	50	50	25	25	25	25	40	40	40	20	20	20	10	30	20
DC reverse voltage VR (V)	8	16	8	5	5	10	10	5	5	5	5	5	10	10	10	5	5	4
Forward voltage VF (V)	4	8	4	3.6	3.5	7.2	7	3.6	3.5	3.1	3.1	3.2	6.2	6.2	6.4	1.9	2.1	1.9
Recommended operating current IF (mA)	30	15	15	32	16	16	8	16	8	32	32	16	16	16	8	5	20	10
Current Reduced Factor (Over 25°C working Temperature)	0.66 mA/°C		0.33 mA/°C	1.6 mA/°C		0.4 mA/°C		0.56 mA/°C		0.5 mA/°C	0.56 mA/°C	0.28 mA/°C	0.25 mA/°C	0.28 mA/°C	0.13 mA/°C	0.4 mA/°C	0.26 mA/°C	
Pulse Lighting	Pulse Width PW (μs)		100		≤10 ⁴							≤10 ⁴			100			
	Duty Ratio DR				10 ⁻¹							10 ⁻¹						
	IFM (mA)		120		120		80		80					130			100	
Wiring diagram	Fig. 1	Fig. 2	Fig. 2	Fig. 1				Fig. 2		Fig. 2			Fig. 2			Fig. 1		

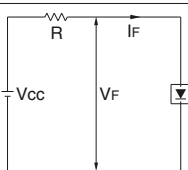

Fig. 1

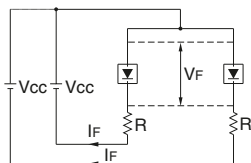

Fig. 2

The value of the series resistor can be determined by the formula:

$$R = \frac{V_{cc} - V_F}{I_F}$$

Vcc: Supply Voltage

VF: Forward Voltage

IF: Forward Current With Guard Cover

LAMP DATA

● LAMP RATING

DC Supply Voltage (V)	Current Rating (mA)	Life (H)	Temperature
6	200	5000 (Average)	Less than 50°C (Button surface)
14	80		
28	40		

Lamp Life is subject to AC use. In case of DC use, approximately 2500H.

Panel Layout/Panel Cut Dimensions

● 14.2mm Square

Panel thickness: 1.0 ~ 3.2mm

		Panel Layout	Panel Cut Dimensions
Without Barriers	Independent		
	Serial (Horizontal)		
	Serial (Vertical)		
With Barriers	Independent		
	Serial (Horizontal)		
	Serial (Vertical)		

In case of Serial (Vertical) mounting, please add 002 suffix to ordering code of switch, which retaining clip come out horizontally.

Converting horizontally mounting switch to vertically mounting, just rotate retaining clip 90° for square type.
And in case of rectangular type, 2pcs. of Long version retaining clips are necessary.

n : number of switches
Tolerance : ±0.4mm

Panel Layout / Panel Cut Dimensions

● 14.2×20.4mm Rectangular

Panel thickness: 1.0 ~ 3.2mm

		Panel Layout	Panel Cut Dimensions
Without Barriers	Independent (Horizontal)		
	Serial (Horizontal)		
	Independent (Vertical)		
	Serial (Vertical)		
With Barriers	Independent (Horizontal)		
	Serial (Horizontal)		
	Independent (Vertical)		
	Serial (Vertical)		

※ Panel Cut Dimension should be after panel paintings.

Note	Without Barriers	With Barriers
<p>In case of Group Mounting, please leave space as below.</p> <p>() = Vertical Mounting</p>	<p style="margin: 0;">more than 3.0 (more than 6.0)</p>	<p style="margin: 0;">more than 6.0</p>

n : number of switches
Tolerance : ±0.4mm

ACCESSORIES

BARRIERS

In case of mounting switches in series, Barriers can be used to prevent inadvertent pushing neighbor switch.

● Short Barrier

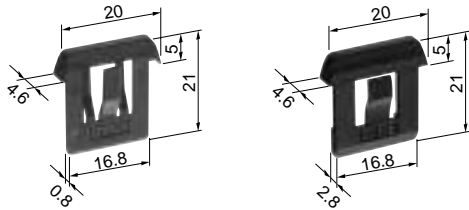

PART NO.		
Color	Short Center Barrier	Short Side Barrier
Black	EH-1084-K	EH-1085-K
Gray	EH-1084-H	EH-1085-H

● Long Barrier (Rectangular, Longer Side)

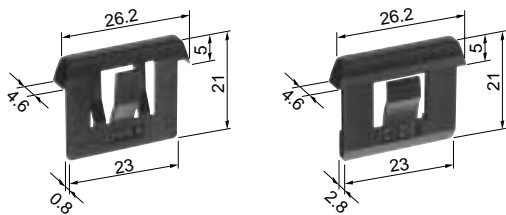

PART NO.		
Color	Long Center Barrier	Long Side Barrier
Black	EH-1086-K	EH-1087-K
Gray	EH-1086-H	EH-1087-H

GUARD COVER

Guard Cover prevents inadvertent and unintentional operations. In EH series Guard Cover should be used with Side /Center Barriers for Guard Cover. Panel cut-out dimension is same as "with barrier". Cannot be used for Dimple Button.

● 14.2mm Square

● 14.2×20.4mm Rectangular

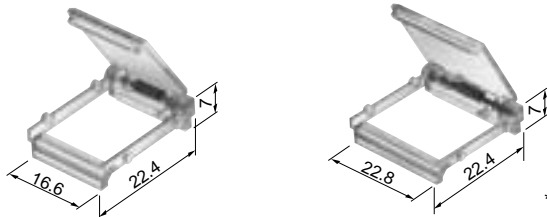

PART NO.	
Square	EH-1080
Rect.	EH-1081

* The cover to be opened 180° and returned by spring force. (Square)
 * The cover to be opened 90° and returned by spring force. (Rectangular)

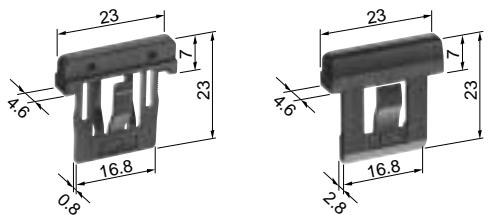

Center Barrier for Guard Cover

Side Barrier for Guard Cover

PART NO.		
Color	Center Barrier for Guard Cover	Side Barrier for Guard Cover
Black	EH-1091-K	EH-1092-K
Gray	EH-1091-H	EH-1092-H

Dust-Proof Cover

● 14.2mm Square

● 14.2×20.4mm Rectangular

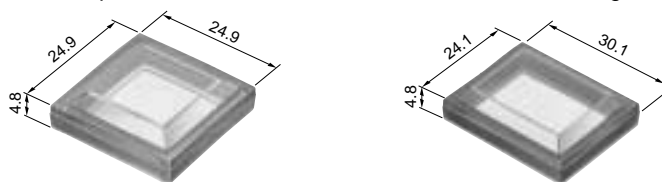

PART NO	
14.2mm Square	14.2×20.4mm Rectangular
DH-361	EH-1083

● Panel Cut Dimensions

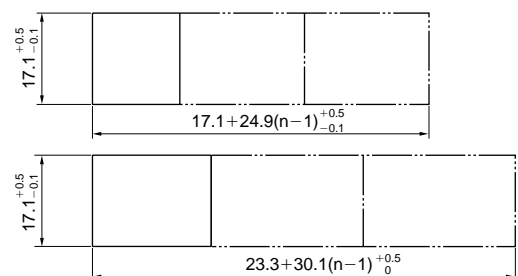

Panel thickness: 1.0 ~ 2.5mm

ACCESSORIES

SOCKET

For easy maintenance. (Can be used for both square and rectangular)

- Soldering Terminal
Full-Face, Spot

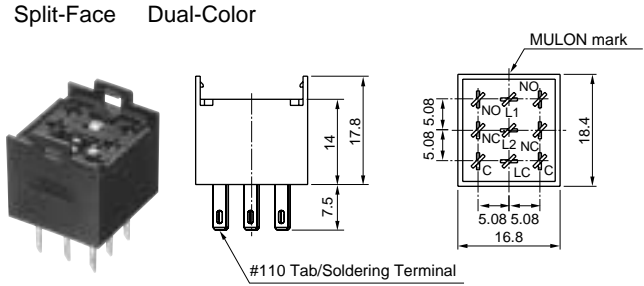
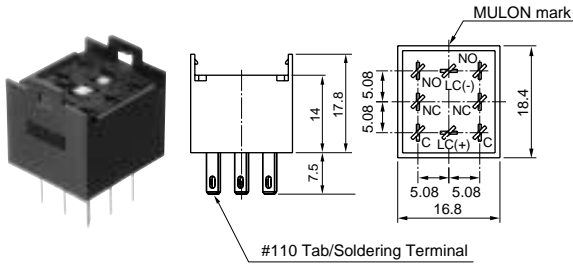

PART No.			
Application	Resistance	Part No.	Note
Full-Face, Spot, Lamp	0Ω	EH-1088-1	Use for built-in resistor type
Split-Face, Dual-Color	0Ω	EH-1088-2	
Split-Face 12V	510Ω 1/4W	EH-3210-2A	Use for non-resistor type
Split-Face 24V	1.3kΩ 1/2W	EH-3210-2B	
Dual-Color 5V	36Ω 1/4W	EH-3210-2C	*Simultaneous lighting is possible.
Dual-Color 12V	270Ω 1/4W	EH-3210-2D	
Dual-Color 24V	1.1kΩ 1/2W	EH-3210-2E	

Tolerance : ±0.4mm

MATRIX FITTING FRAME

- 14.2mm Square

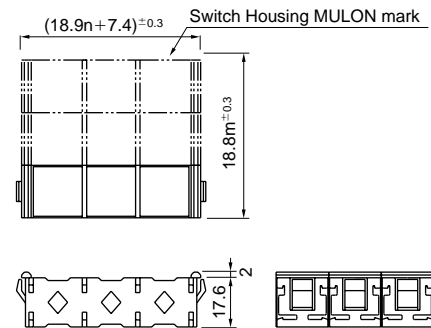
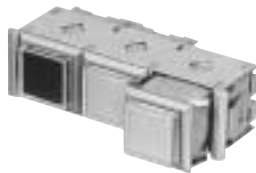

- 14.2×20.2mm Rectangular

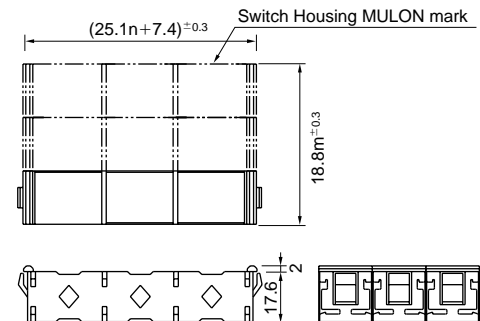

	14.2mm Square	14.2×20.2mm Rectangular
Panel Cut Dimensions		

Color	14.2mm Square	14.2×20.2mm Rectangular
Black	EH-1610-K□	EH-1815-K□
Gray	EH-1610-H□	EH-1815-H□

□ = number of switch (1-15)
 n : number of switches (Horizontal)
 m : number of switches (Vertical)
 Panel thickness: 1.0 ~ 3.2mm

Tolerance : ±0.4mm

FILTER DIMENSIONS

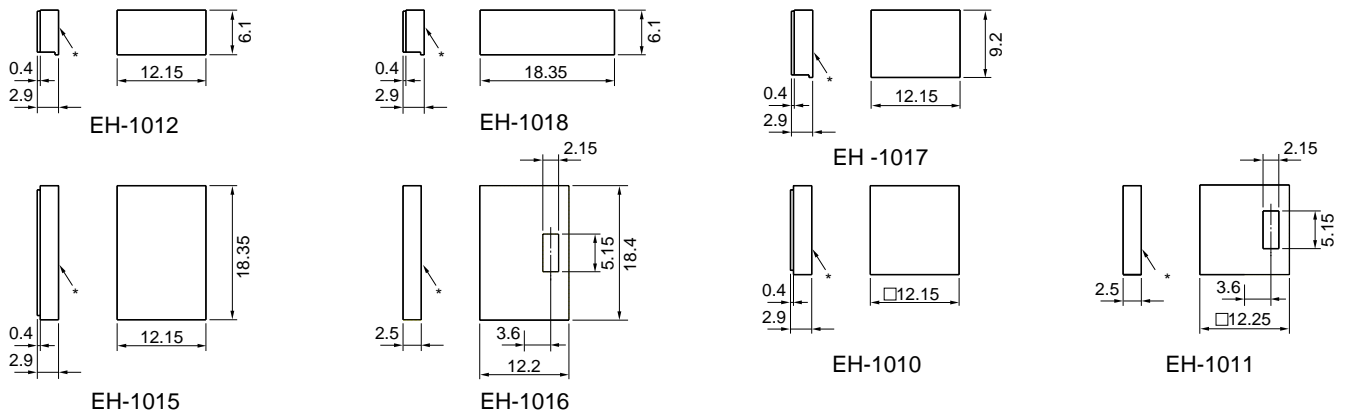

*LEGEND FACE

REPLACEMENT PARTS

Please order replacement parts with Part No.

● Button/Filter for LED Illumination

Item \ color	Red	Green	Yellow	Blue	Milk-White	Clear	Dimple
14.2mm Square Button	EH-1008-1LR	EH-1008-1LG	EH-1008-1LY	EH-1008-1LB	EH-1008-1LM	/	/
14.2×20.4mm Rect. Button	EH-1013-1LR	EH-1013-1LG	EH-1013-1LY	EH-1013-1LB	EH-1013-1LM		
Square Full-Face Filter	EH-1010-LR	EH-1010-LG	EH-1010-LY	EH-1010-LB	EH-1010-LM		
Rect. Full-Face Filter	EH-1015-LR	EH-1015-LG	EH-1015-LY	EH-1015-LB	EH-1015-LM		
Square Split-Face Filter	EH-1012-LR	EH-1012-LG	EH-1012-LY	EH-1012-LB	EH-1012-LM		
Rect. Split-Face (horiz.) Filter	EH-1018-LR	EH-1018-LG	EH-1018-LY	EH-1018-LB	EH-1018-LM		
Rect. Split-Face (vert.) Filter	EH-1017-LR	EH-1017-LG	EH-1017-LY	EH-1017-LB	EH-1017-LM		

● Divider for Split-Face

	Square Split-Face	Rect. Split-Face(vertical)	Rect. Split-Face(horizontal)
Part No.	EH-3182		EH-3183

● Button/Filter for Spot

Item \ color	Red	Green	Yellow	Milk-White	White	Blue	Black	Clear
14.2mm Square Button	EH-1009-R	EH-1009-G	EH-1009-Y	EH-1009-M	EH-1009-W	EH-1009-B	EH-1009-K	EH-1009-C
14.2×20.4mm Rect. Button	EH-1014-R	EH-1014-G	EH-1014-Y	EH-1014-M	EH-1014-W	EH-1014-B	EH-1014-K	EH-1014-C
Square Full-Face Filter	EH-1011-R	EH-1011-G	EH-1011-Y	EH-1011-M	EH-1011-W	EH-1011-B	EH-1011-K	/
Rect. Full-Face Filter	EH-1016-R	EH-1016-G	EH-1016-Y	EH-1016-M	EH-1016-W	EH-1016-B	EH-1016-K	

● Button/Filter for Lamp

Item \ color	Red	Green	Yellow	Milk-White	White	Blue	Black	Clear
14.2mm Square Button	EH-1008-1R	EH-1008-1G	EH-1008-1Y	EH-1008-1M	EH-1008-1W	EH-1008-1B	EH-1008-1K	EH-1008-2C
14.2×20.4mm Rect. Button	EH-1013-1R	EH-1013-1G	EH-1013-1Y	EH-1013-1M	EH-1013-1W	EH-1013-1B	EH-1013-1K	EH-1013-2C
Square Full-Face Filter	EH-1010-R	EH-1010-G	EH-1010-Y	EH-1010-M	EH-1010-W	EH-1010-B	EH-1010-K	/
Rect. Full-Face Filter	EH-1015-R	EH-1015-G	EH-1015-Y	EH-1015-M	EH-1015-W	EH-1015-B	EH-1015-K	

● Long Retaining Clip

Part No.	EH-1034-2
----------	-----------

● Lamp T-1 3/4 midget grooved base

Voltage	6V	14V	28V
Part No.	MU-089-1	MU-089-2	MU-089-3

Tolerance : ±0.4mm

ASSEMBLY & DISASSEMBLY

1. Removing Light Cartridge

Hang the cartridge with hooking fingernails in the groove, and pull out.

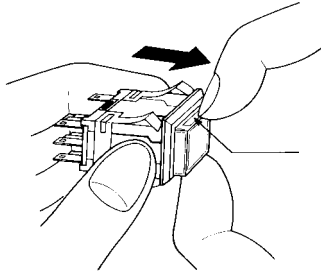
**2. Removing Button**

Hook fingernails at A and gently release the clip, and release another side as well.

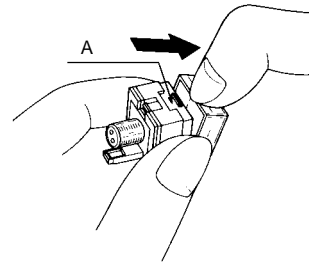
**3. Fitting Divider (Split-Face)**

Fit divider on the groove accordingly.

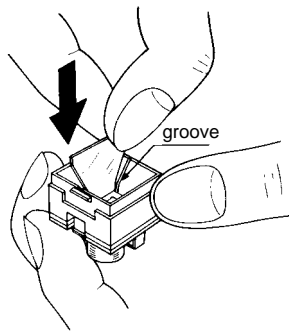
**4. Fitting Filter(s)**

Set Filter(s) as shown onto cartridge carefully, then put button on.

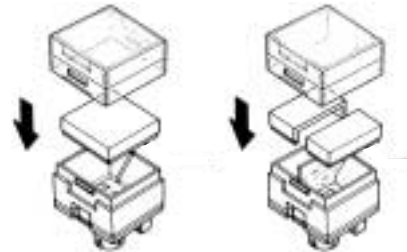
**5. Fitting Button**

Fit the button as shown until click.

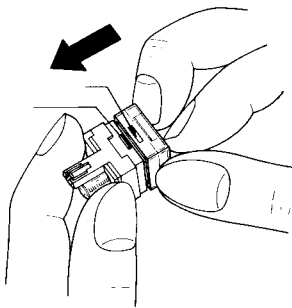
**6. Fitting Light Cartridge**

Insert Light Cartridge into Housing with right direction and push in until click.

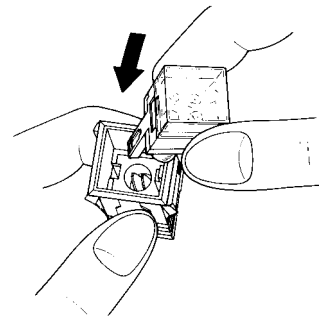
**7. Removing Lamp**

Pull out Lamp with the tool (DH-409).

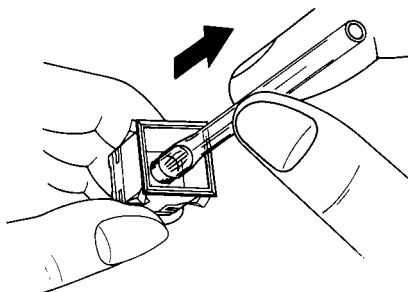
**8. Fitting Lamp**

Fit Lamp as shown until click.

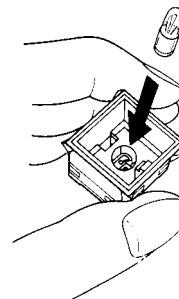

ASSEMBLY & DISASSEMBLY

9. Installing Barriers (Independent)

Install Side Barriers with Switch as shown.

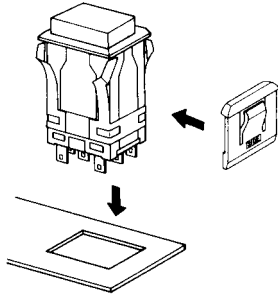

● Installing Barriers (Serial)

Install Side Barriers with Switch and install Center Barrier between Switches.

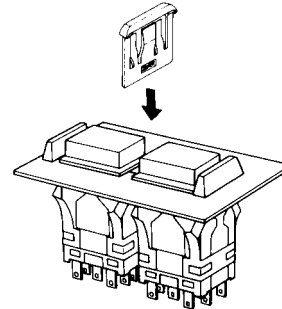

10. Installing Dustproof Cover

Put the switch through the Frame of cover and mount on panel. And then, install transparent cap with fitting projection and groove of frame.

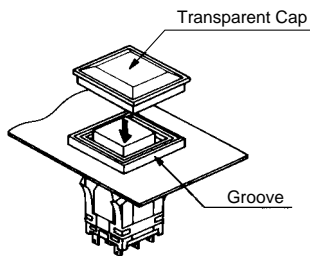

11. Fitting Socket

Insert Switch into Socket with right direction (MULON mark of switch and socket should be same side) and push until stop.

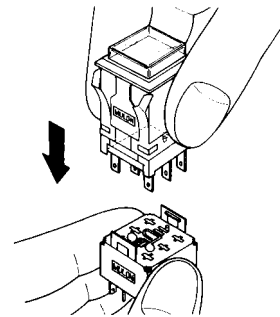

12. Installing Guard Cover

Independent mounting (Fig. 1)

Fit side barriers, cover and switch as shown and mount together.

Fit side barriers and switches and mount on panel, and install center barriers, finally install covers with extending barriers' head. (Fig.2)

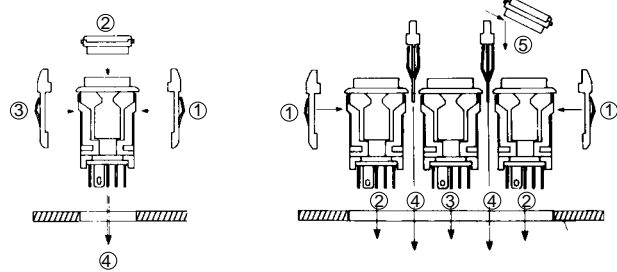
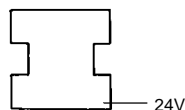

Fig.1

Fig.2

13. LED voltage supply rating

DC voltage supply rating for LED is shown on the underside of Light Cartridge.



14. Matrix Fitting Frame

Install switches with frame and mount on panel as shown.

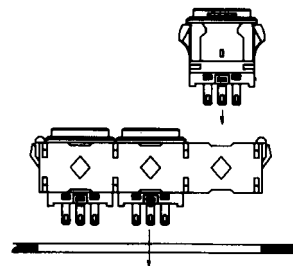

ORDERING CODE

LED Illumination

EH — 1 2 1 2

● OPERATION

M	Momentary
A	Alternate
L	Indicator
※ F	Flat Indicator

※ Button level is flat.(locked position)

● CONTACT

0	Indicator
3	SPDT Silver (Gold-Plated)
4	DPDT Silver (Gold-Plated)
5	SPDT W/E Alloy #1Crossbar
6	DPDT W/E Alloy #1Crossbar

● BUTTON SHAPE ILLUMINATION TYPE

S0	Square Full-Face	K0	Dimple B. Square Full-Face
W0	Rect. Full-Face	K1	Dimple B. Split-Face (Vert.)
S1	Square Split-Face (Vert.)	K2	Dimple B. Split-Face (Horiz.)
S2	Square Split-Face (Horiz.)	K3	Dimple B. Square Dual-Color
W1	Rect. Split-Face (Vert.)	N0	Dimple B. Rect. Full-Face
W2	Rect. Split-Face (Horiz.)	N1	Dimple B. Rect. Split-Face (Vert.)
S3	Square Dual-Color	N2	Dimple B. Rect. Split-Face (Horiz.)
W3	Rect. Dual-Color	N3	Dimple B. Rect. Dual-Color

● LED COLOR

70	Red	Full-Face : Put color no. into the frame 1 Split-Face : Put color no. into the frame 1,2 (7070, 7080, 7090, 8070, 8080, 8090 9070, 9080, 9090, 1414, 1416, 1418 1614, 1616, 1618, 1814, 1816, 1818 7014, 7016, 7018, 9014, 1470, 1670 1870, 1490 Combination only)
80	Green	
90	Yellow	Dual-Color : Put color no. into the frame 1,2 (7080, 8090, 9070, 7014, 7016, 7018 9014, 1416, 1618, 1814 Combination only)
14	Super Blue	
16	Super White	
18	Super Green	

● Supply Voltage to LED

1	5V Built-in Resistor
2	12V Built-in Resistor
3	24V Built-in Resistor(not for Split-Face)
4	5V Non-Resistor, Split-Face non resistor
5	12V Non-Resistor
6	24V Non-Resistor

In case of Split-Face non resistor type, please select 4 though the circuits are same for 5, 12, 24v, for our convenience.

● TERMINAL

P	#110 Tab, Soldering
C	PCB
K	Connector

● FILTER COLOR

1	Red	Full-Face : Put color no. into the frame 1 Split-Face : Put color no. into the frame 1,2
2	Green	
3	Yellow	
4	Milk White	
6	Blue	
★ ×	Without Filter	

★ Generally, in case of using color button, filters are not necessary.

● BUTTON COLOR

R	Red
G	Green
Y	Yellow
M	Milk White
B	Blue
C	Clear

● Housing

K	Black
H	Gray

● NOTES

1) In case of Split-Face, LED and Filter color location should be specified as follow:

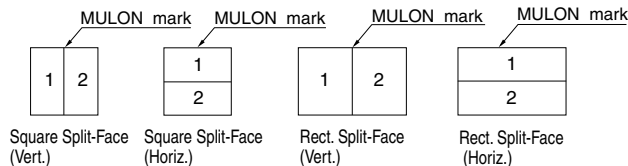

- In case of Split-Face, button color should be C (clear).
- In case of Dual-Color, button should be C (clear) with Milk-White filter or Milk-White button.
- Dimple Button type is only clear color. Therefore, button color should be C (clear).
- Please be noted that the color of "Yellow" for LED Button Filter is actually "Orange Yellow" not Lemon Yellow.

Notes for Split-Face and Dual-Color Illumination type

In case of using Split-Face & Dual-Color, sometimes built-in resistor type cannot be used because of heating. Please note followings:

① Split-Face

5V use : Select 1 (5V built-in resistor). Simultaneous lighting is possible.

12V use : Select 2 (12V built-in resistor). However in case of simultaneous lighting, please select 4 (non resistor) and apply external resistor 510 Ω 1/4W in series or use socket (EH-3210-2A)

24V use : Either do or not do simultaneous lighting, cannot select 3 (24V built-in resistor). Please select 4 (non resistor) and apply external resistor 1.3kΩ 1/2W in series or use socket (EH-3210-2B). Simultaneous lighting is possible for both way.

In 5V, 12V, 24V Split-Face non resistor type, they are the same circuits actually, however please select 4 (Split-Face non resistor) for our convenience.

② Dual Color

It is impossible to do simultaneous lighting with all 5V,12V,24V. In case of simultaneous lighting, please select 4,5,6 respectively and apply external resistor 36Ω 1/4W, 270Ω 1/4W, 1.1kΩ 1/2W in series or use socket (EH-3210-2C),(EH-3210-2D)(EH-3210-2E) respectively.

In 5V, 12V, 24V Dual-Color non resistor type, the circuit is different. Even a case of "simultaneous lighting impossible", it is all right for couple of minutes.

ORDERING CODE

LED SPOT



● OPERATION

M	Momentary
A	Alternate
L	Indicator
※ F	Flat Indicator

※ Button level is flat.(locked position)

● CONTACT

0	Indicator
3	SPDT Silver (Gold-Plated)
4	DPDT Silver (Gold-Plated)
5	SPDT W/E Alloy #1Crossbar
6	DPDT W/E Alloy #1Crossbar

● BUTTON SHAPE

S0	Square
W0	Rect.

● LED COLOR

4	Red
5	Green
6	Yellow

● TERMINAL

P	#110 Tab/Soldering
C	PCB
K	Connector

● Supply Voltage to LED

1	5V Built-in Resistor
2	12V Built-in Resistor
3	24V Built-in Resistor
4	Non-Resistor

● HOUSING COLOR

K	Black
H	Gray

● FILTER COLOR

1	Red
2	Green
3	Yellow
4	Milk-White
6	Blue
7	Black
×	Without Filter

● BUTTON COLOR

R	Red	B	Blue
G	Green	K	Black
Y	Yellow	C	Clear
M	Milk White		

LAMP



● OPERATION

M	Momentary
A	Alternate
L	Indicator
※ F	Flat Indicator

※ Button level is flat.(locked position)

● CONTACT

0	Indicator
3	SPDT Silver (Gold-Plated)
4	DPDT Silver (Gold-Plated)
5	SPDT W/E Alloy #1Crossbar
6	DPDT W/E Alloy #1Crossbar

● BUTTON SHAPE

S	Square
W	Rect.

● Lamp Voltage

0	Without Lamp
1	6V
2	14V
3	28V
X	Without Lamp terminal

● TERMINAL

P	#110 Tab/Soldering
C	PCB
K	Connector

● FILTER COLOR

1	Red
2	Green
3	Yellow
4	Milk-White
6	Blue
7	Black
×	Without Filter

● HOUSING COLOR

K	Black
H	Gray

● BUTTON COLOR

R	Red	B	Blue
G	Green	K	Black
Y	Yellow	C	Clear
M	Milk White		

ORDERING CODE 2

It is possible to order individually Light Cartridge and Housing.

● LIGHT CARTRIDGE

LED

EH — 1 2 1 2

● BUTTON SHAPE ILLUMINATION TYPE

S0	Square Full-Face
W0	Rect. Full-Face
S1	Square Split-Face (Vert.)
S2	Square Split-Face (Horiz.)
W1	Rect. Split-Face (Vert.)
W2	Rect. Split-Face (Horiz.)
S3	Square Dual-Color
W3	Rect. Dual-Color

K0	Dimple B. Square Full-Face
K1	Dimple B. Split-Face (Vert.)
K2	Dimple B. Split-Face (Horiz.)
K3	Dimple B. Square Dual-Color
N0	Dimple B. Rect. Full-Face
N1	Dimple B. Rect. Split-Face (Vert.)
N2	Dimple B. Rect. Split-Face (Horiz.)
N3	Dimple B. Rect. Split-Face

● LED COLOR

70	Red	Full-Face : Put color no. into the frame 1 Split-Face : Put color no. into the frame 1,2
80	Green	$\left(\begin{array}{l} 7070, 7080, 7090, 8070, 8080, 8090 \\ 9070, 9080, 9090, 1414, 1416, 1418 \\ 1614, 1616, 1618, 1814, 1816, 1818 \\ 7014, 7016, 7018, 9014, 1470, 1670 \\ 1870, 1490 \text{ Combination only} \end{array} \right)$
90	Yellow	
14	Super Blue	
16	Super White	
18	Super Green	Dual-Color : Put color no. into the frame 1,2
		$\left(\begin{array}{l} 7080, 8090, 9070, 7014, 7016, 7018 \\ 9014, 1416, 1618, 1814 \text{ Combination only} \end{array} \right)$

● Supply Voltage to LED

1	5V Built-in Resistor
2	12V Built-in Resistor
3	24V Built-in Resistor(not for Split-Face)
4	5V Non-Resistor, Split-Face non resistor
5	12V Non-Resistor
6	24V Non-Resistor

In case of Split-Face non resistor type, please select 4 though the circuits are same for 5, 12, 24v, for our convenience.

● FILTER COLOR

1	Red
2	Green
3	Yellow
4	Milk White
6	Blue
×	Without Filter

● BUTTON COLOR

R	Red
G	Green
Y	Yellow
M	Milk White
C	Clear
B	Blue
×	Without Button

● NOTES

1) In case of Split-Face, LED and Filter color location should be specified as follow:

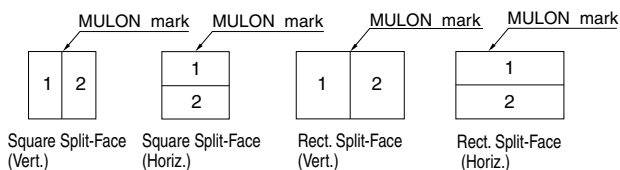

- In case of Split-Face, button color should be C (clear).
- In case of Dual-Color, button should be C (clear) with Milk-White filter or Milk-White button.
- Dimple Button type is only clear color. Therefore, button color should be C (clear).
- Please be noted that the color of "Yellow" for LED Button Filter is actually "Orange Yellow" not Lemon Yellow.

Notes for Split-Face and Dual-Color Illumination type

In case of using Split-Face & Dual-Color, sometimes built-in resistor type cannot be used because of heating. Please note followings:

① Split-Face

- 5V use : Select 1 (5V built-in resistor). Simultaneous lighting is possible.
- 12V use : Select 2 (12V built-in resistor). However in case of simultaneous lighting, please select 4 (non resistor) and apply external resistor 510 Ω 1/4W in series or use socket (EH-3210-2A)
- 24V use : Either do or not do simultaneous lighting, cannot select 3 (24V built-in resistor). Please select 4 (non resistor) and apply external resistor 1.3kΩ 1/2W in series or use socket (EH-3210-2B). Simultaneous lighting is possible for both way.
In 5V, 12V, 24V Split-Face non resistor type, they are the same circuits actually, however please select 4 (Split-Face non resistor) for our convenience.

② Dual Color

It is impossible to do simultaneous lighting with all 5V,12V,24V. In case of simultaneous lighting, please select 4,5,6 respectively and apply external resistor 36Ω 1/4W, 270Ω 1/4W, 1.1kΩ 1/2W in series or use socket (EH-3210-2C),(EH-3210-2D)(EH-3210-2E) respectively.
In 5V, 12V, 24V Dual-Color non resistor type, the circuit is different. Even a case of "simultaneous lighting impossible", it is all right for couple of minutes.

ORDERING CODE 2

LED SPOT

EH — [] [] [] [] []

● BUTTON SHAPE

S0	Square
W0	Rect.

● LED COLOR

4	Red
5	Green
6	Yellow

● BUTTON COLOR

R	Red	M	Milk-White	C	Clear
G	Green	B	Blue	×	Without Button
Y	Yellow	K	Black		

● Supply Voltage to LED

1	5V Built-in Resistor
2	12V Built-in Resistor
3	24V Built-in Resistor
4	Non-Resistor

● FILTER COLOR

1	Red	6	Blue
2	Green	7	Black
3	Yellow	×	Without Filter
4	Milk-White		

LAMP

EH — [] [] [] []

● BUTTON SHAPE

S	Square
W	Rect.

● Lamp Voltage

0	Without Lamp
1	6V
2	14V
3	28V

● FILTER COLOR

1	Red	6	Blue
2	Green	7	Black
3	Yellow	×	Without Filter
4	Milk-White		

● BUTTON COLOR

R	Red	M	Milk-White	C	Clear
G	Green	B	Blue	×	Without Button
Y	Yellow	K	Black		

HOUSING

EH [] — [] [] [] []

● OPERATION

M	Momentary
A	Alternate
L	Indicator
※ F	Flat Indicator

※ Button level is flat.(locked position)

● CONTACT

0	Indicator
3	SPDT Silver (Gold-Plated)
4	DPDT Silver (Gold-Plated)
5	SPDT W/E Alloy #1Crossbar
6	DPDT W/E Alloy #1Crossbar

● TERMINAL

P	#110 Tab/Solder
C	PCB
K	Connector

● HOUSING COLOR

K	Black
H	Gray

● BUTTON SHAPE ILLUMINATION TYPE

S	Square Lamp	S1	Square Split-Face, Dual-Color
W	Rect. Lamp	W1	Rect. Split-Face, Dual-Color
S0	Square Full-Face, Spot	SX	Square Without Lamp terminal
W0	Rect. Full-Face, Spot	WX	Rect. Without Lamp terminal