

特点：

- n 芯片与底板电气绝缘,2500V 交流电压
 - n 全压接结构,优良的温度特性和功率循环能力
 - n 体积小,重量轻
- 典型应用：**
- n 仪器设备的直流电源
 - n PWM 变频器的输入整流电源
 - n 逆变焊机

I_o	50A
V_{RRM}	600~1600V
I_{FSM}	0.75 KA
I^2t	$2.8 \cdot 10^3 A^2S$

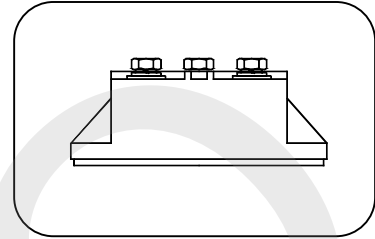

符号	参数	测试条件	结温 $T_j(^{\circ}C)$	参数值			单位
				最小	典型	最大	
I_o	直流输出电流	三相全波整流电路, $T_c=100^{\circ}C$	150			50	A
V_{RRM}	反向重复峰值电压	$V_{RRM} \text{ tp}=10\text{ms}$ $V_{RSM} = V_{RRM}+200V$	150	600		1600	V
I_{RRM}	反向重复峰值电流	at V_{RRM}	150			4	mA
I_{FSM}	正向不重复浪涌电流	10ms 正弦半波	150			0.75	KA
I^2t	浪涌电流平方时间积	$V_R=0.6V_{RRM}$				2.8	$A^2s \cdot 10^3$
V_{FO}	门槛电压		150			0.8	V
r_F	斜率电阻					9.0	mW
V_{FM}	正向峰值电压	$I_{FM}=50A$	25			1.20	V
$R_{th(j-c)}$	热阻抗(结至壳)	单面散热				0.30	$^{\circ}C/W$
$R_{th(c-h)}$	热阻抗(壳至散热器)	单面散热				0.15	$^{\circ}C/W$
V_{iso}	绝缘电压	50Hz, R.M.S, t=1min, $I_{iso}:1mA(max)$		2500			V
F_m	安装扭矩(M5)					4	N·m
	安装扭矩(M6)					6	N·m
T_{stg}	贮存温度			-40		125	$^{\circ}C$
W_t	质量					200	g
Outline	220F5/218F5/219F5						

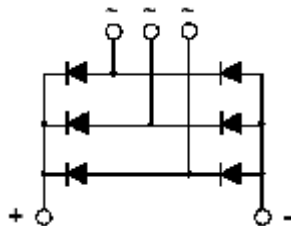

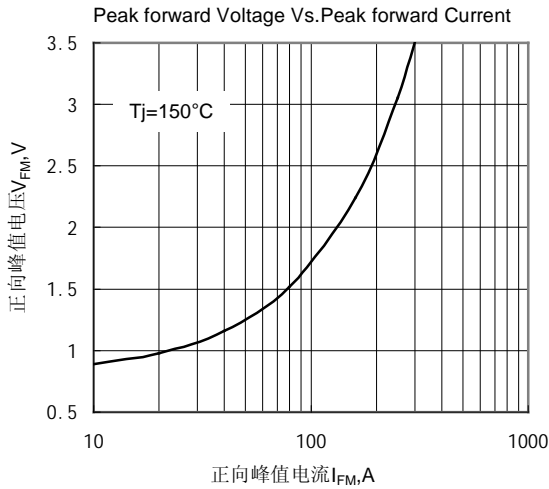

Fig.1 正向伏安特性曲线

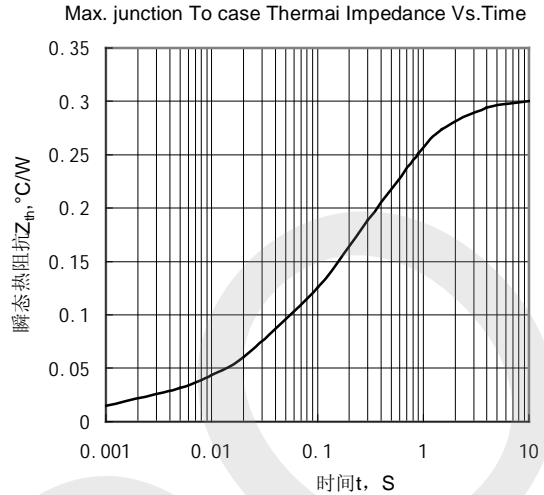

Fig.2 瞬态热阻抗曲线

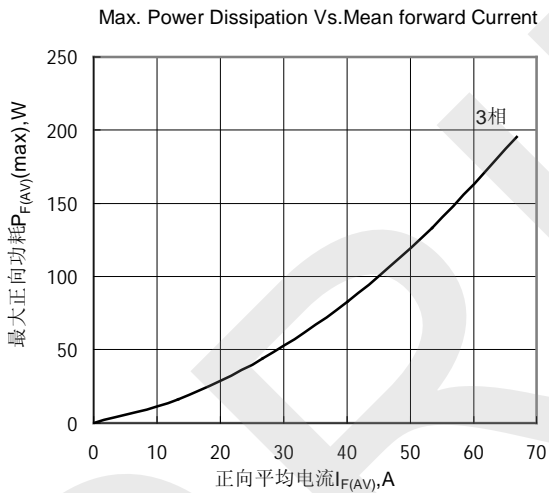

Fig.3 最大正向功耗与平均电流的关系曲线

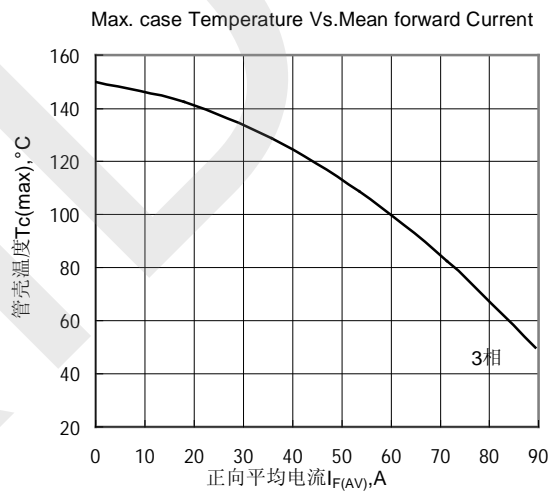

Fig.4 管壳温度与平均电流的关系曲线

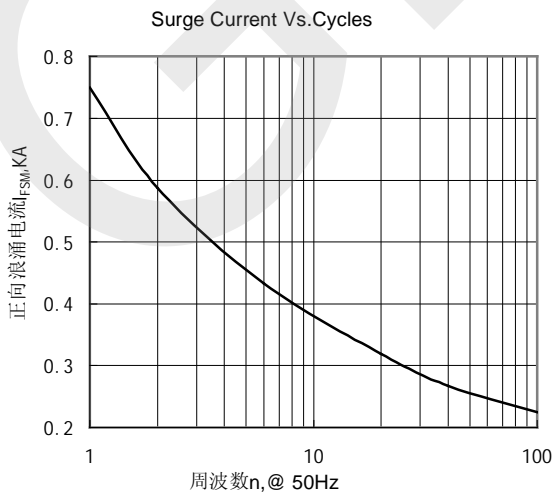

Fig.5 正向浪涌电流与周波数的关系曲线

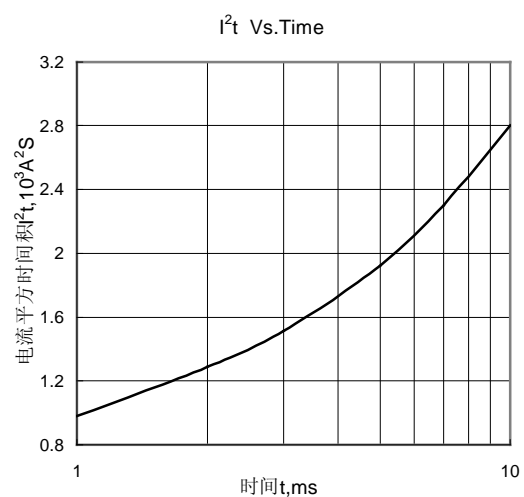
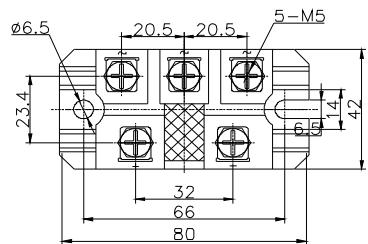
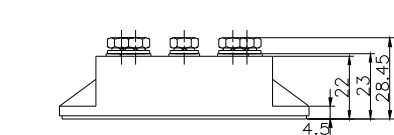
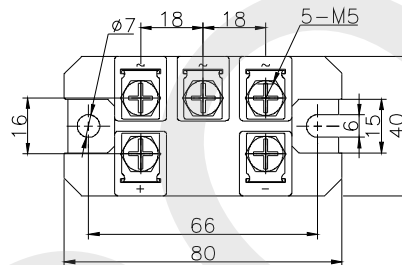
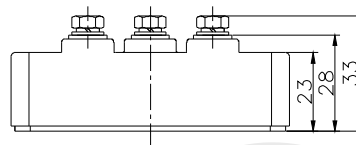

Fig.6 I^2t 特性曲线

外形图:



220F5



218F5

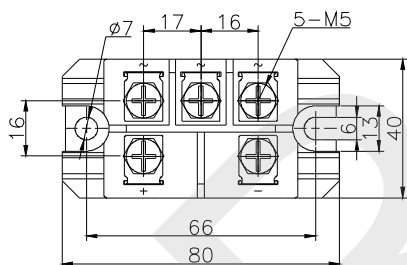
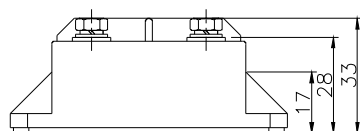

219F5

MDS40A

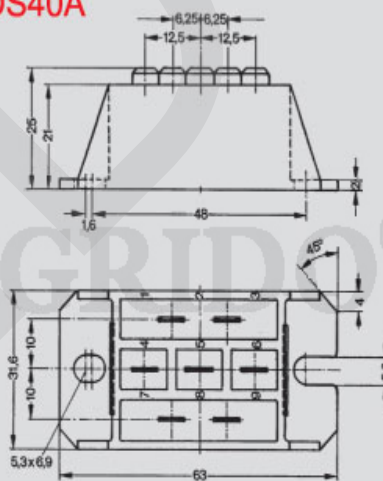

MDS60A-A

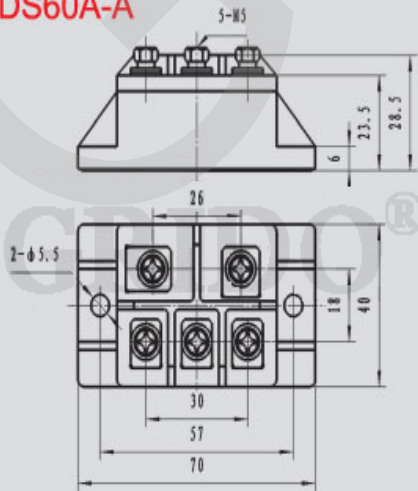

MDS60A-B

