



## Technical Data Sheet

# Infrared Remote-control Receiver Module

**IRM-8755**

### Features

- High protection ability against EMI .
- Oval lens to improve the receive angles.
- Line-up for various center carrier frequencies.
- Low voltage and low power consumption.
- High immunity against ambient light.
- Photodiode with integrated circuit.
- TTL and CMOS compatibility.
- Long reception distance.
- High sensitivity.



### Descriptions

The device is a miniature type infrared remote control system receiver which has been developed and designed by utilizing the most updated IC technology. The PIN diode and preamplifier are assembled on lead frame, the epoxy package is designed as an IR filter. The demodulated output signal can directly be decoded by a microprocessor.

### Applications

1. Optical switch
2. Light detecting portion of remote control
  - AV instruments such as Audio, TV, VCR, CD, MD, etc.
  - Home appliances such as Air-conditioner, Fan , etc.
  - The other equipments with wireless remote control.
  - CATV set top boxes
  - Multi-media Equipment

### Device Selection Guide

| PART      | MATERIAL | COLOR        |
|-----------|----------|--------------|
| Chip      | Silicon  | -----        |
| Metal can | Tinplate | Silver-white |
| Package   | Epoxy    | Black        |

**Package Dimensions**

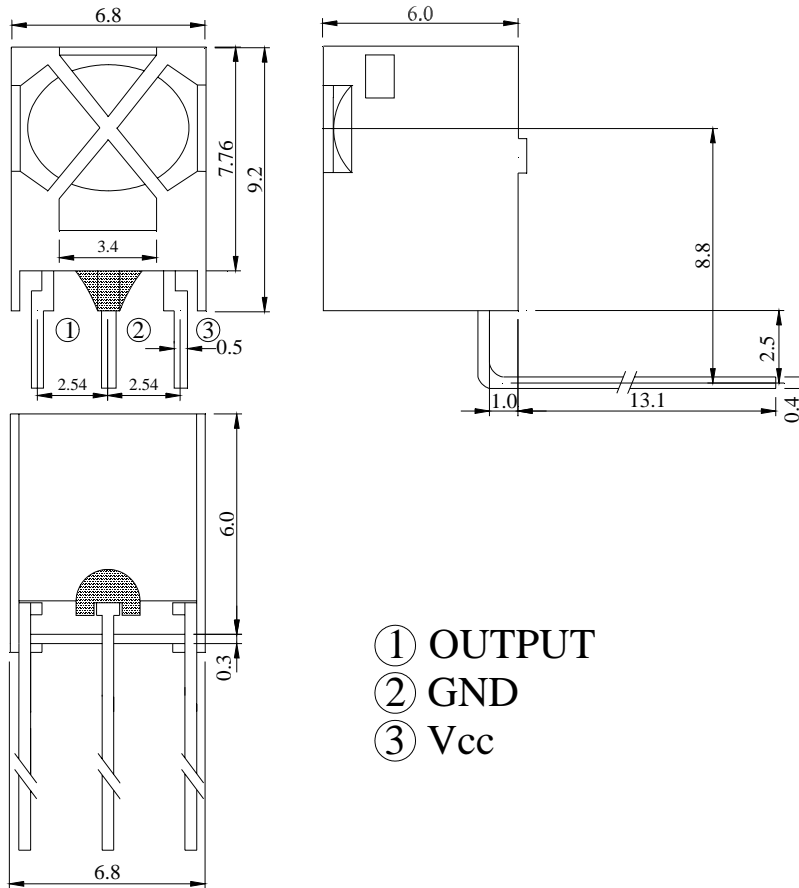

**Notes:** 1.All dimensions are in millimeters.  
2.Tolerances unless dimensions  $\pm 0.3$ mm.

**Absolute Maximum Ratings (Ta=25°C)**

| Parameter             | Symbol | Rating    | Unit | Notice                                     |
|-----------------------|--------|-----------|------|--|
| Supply Voltage        | Vcc    | 0~6       | V    |  |
| Operating Temperature | Topr   | -25 ~ +85 | °C   |  |
| Storage Temperature   | Tstg   | -40 ~ +85 | °C   |  |
| Soldering Temperature | Tsol   | 260       | °C   | 4mm from mold body<br>less than 10 seconds |

**Recommended Operating Condition**
**Supply Voltage Rating: Vcc 4.5V to 5.5V**
**Electro-Optical Characteristics (Ta=25°C, and Vcc=5 V)**

| Parameter                 | Symbol          | MIN. | TYP. | MAX. | Unit    | Condition             |
|---------------------------|-----------------|------|------|------|---------|-----------------------|
| Consumption Current       | I <sub>cc</sub> | ---  | ---  | 3    | mA      | No signal input       |
| B.P.F Center Frequency    | F <sub>0</sub>  | ---  | 38   | ---  | KHz     |                       |
| Peak Wavelength           | $\lambda_p$     | ---  | 940  | ---  | nm      |                       |
| Reception Distance        | L <sub>0</sub>  | 8    | ---  | ---  | m       | At the ray axis<br>*1 |
|                           | L <sub>45</sub> | 4    | ---  | ---  |         |                       |
| Half Angle(Horizontal)    | $\Theta_h$      | ---  | 45   | ---  | deg     |                       |
| Half Angle(Vertical)      | $\Theta_v$      | ---  | 45   | ---  | deg     |                       |
| High Level Pulse Width    | T <sub>H</sub>  | 400  | ---  | 800  | $\mu s$ | At the ray axis<br>*2 |
| Low Level Pulse Width     | T <sub>L</sub>  | 400  | ---  | 800  | $\mu s$ |                       |
| High Level Output Voltage | V <sub>H</sub>  | 4.5  | ---  | ---  | V       |                       |
| Low Level Output Voltage  | V <sub>L</sub>  | ---  | 0.2  | 0.5  | V       |                       |

**Notes:**

\*1:The ray receiving surface at a vertex and relation to the ray axis in the range of  $\theta=0^\circ$  and  $\theta=45^\circ$ .

\*2:A range from 30cm to the arrival distance. Average value of 50 pulses.

**Test Method :**

The specified electro-optical characteristics is satisfied under the following Conditions at the controllable distance.

① Measurement place

A place that is nothing of extreme light reflected in the room.

② External light

Project the light of ordinary white fluorescent lamps which are not high Frequency lamps and must be less then 10 Lux at the module surface.

( $E_e \leq 10\text{Lux}$ )

③ Standard transmitter

A transmitter whose output is so adjusted as to  $V_o=400\text{mVp-p}$  and the output Wave form shown in Fig.-1. According to the measurement method shown in Fig.-2 the standard transmitter is specified.

However , the infrared photodiode to be used for the transmitter should be  $\lambda_p=940\text{nm}, \Delta\lambda=50\text{nm}$ . Also, photodiode is used of PD438B ( $V_r=5\text{V}$ ).

(Standard light / Light source temperature  $2856^\circ\text{K}$ ).

④ Measuring system

According to the measuring system shown in Fig.-3

Fig.-1 Transmitter Wave Form

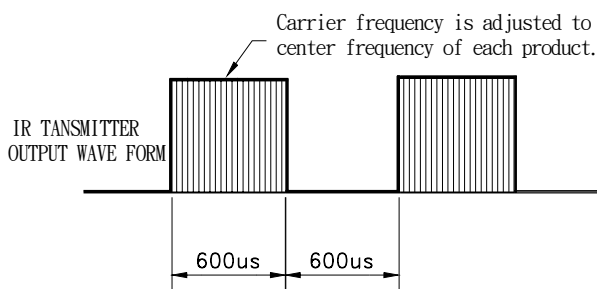

D.U.T output Pulse

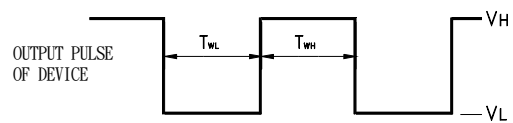

Duty=0.5

Fig.-2 Measuring Method

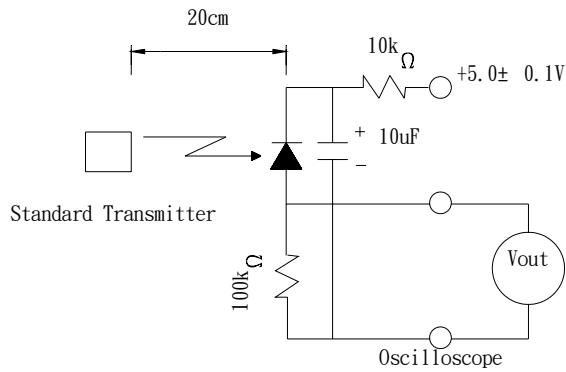
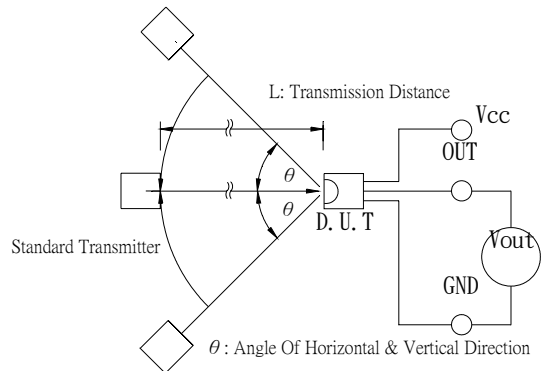
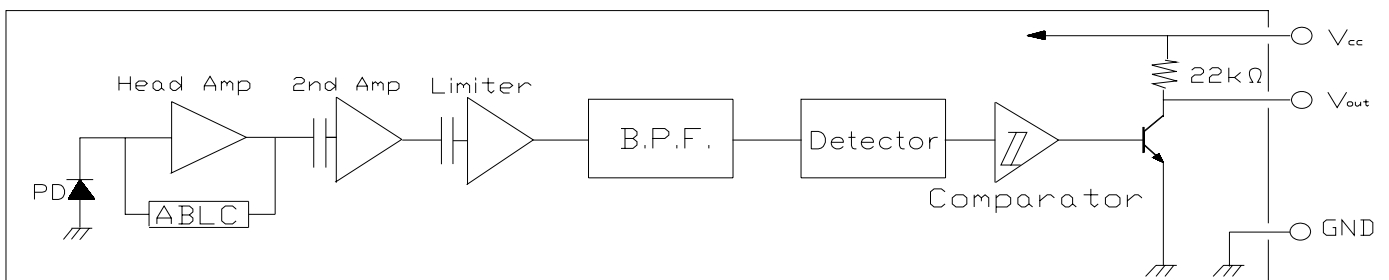

Fig.-3 Measuring System



**Block Diagram :**



**Application Circuit :**

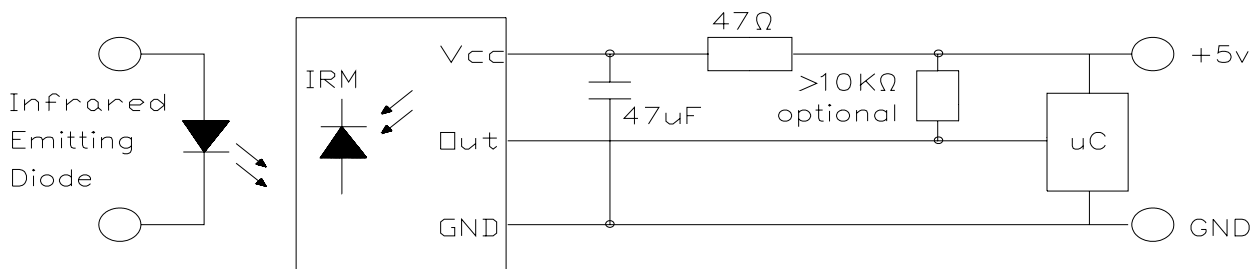

RC Filter should be connected closely between Vcc pin and GND pin.

**Typical Electro-Optical Characteristics Curves**

Fig.-4 Relative Spectral Sensitivity vs.

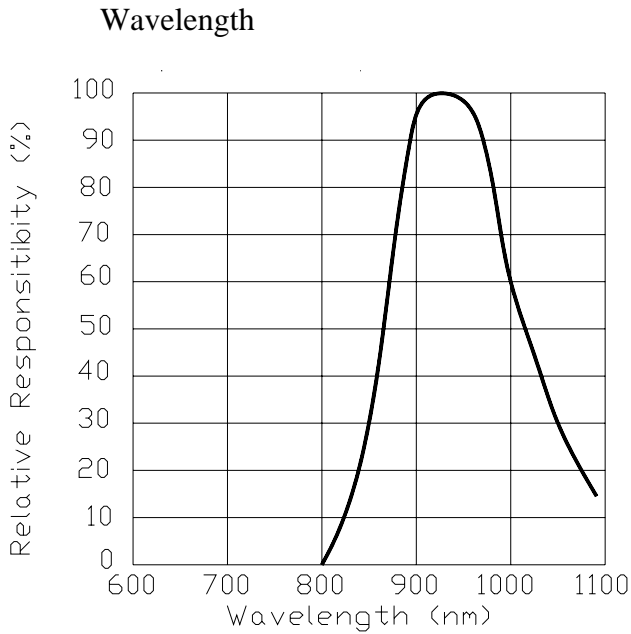

Fig.-5 Relative Transmission Distance vs.

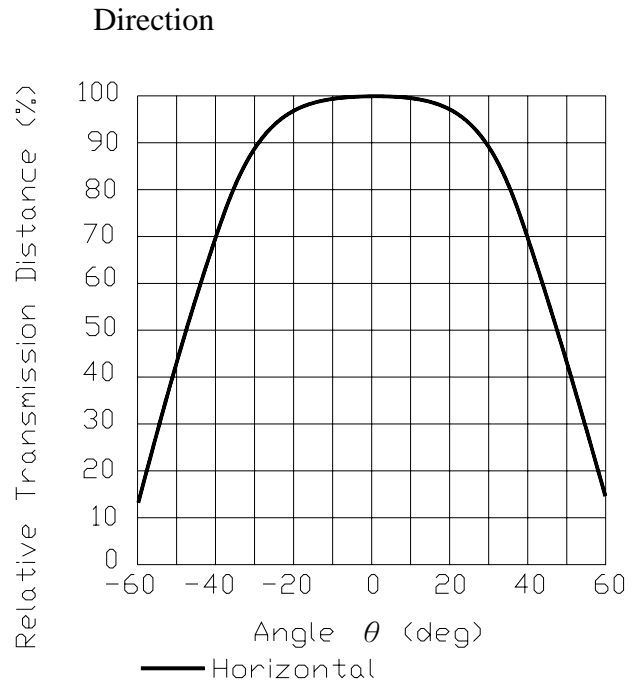

Fig.-6 Output Pulse Length vs. Arrival Distance

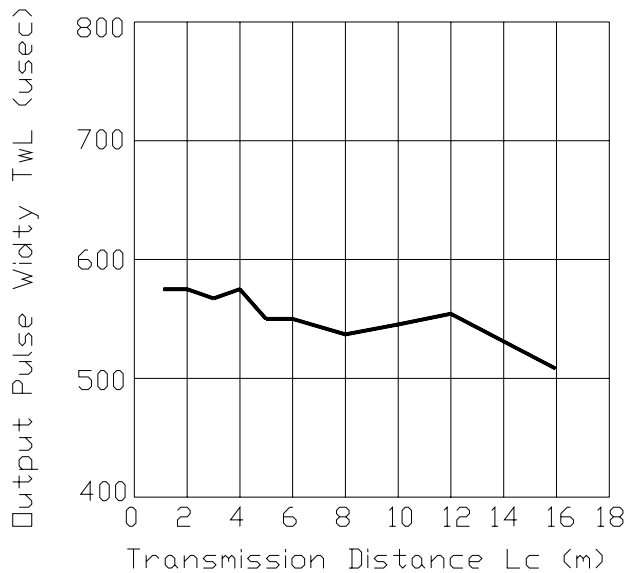
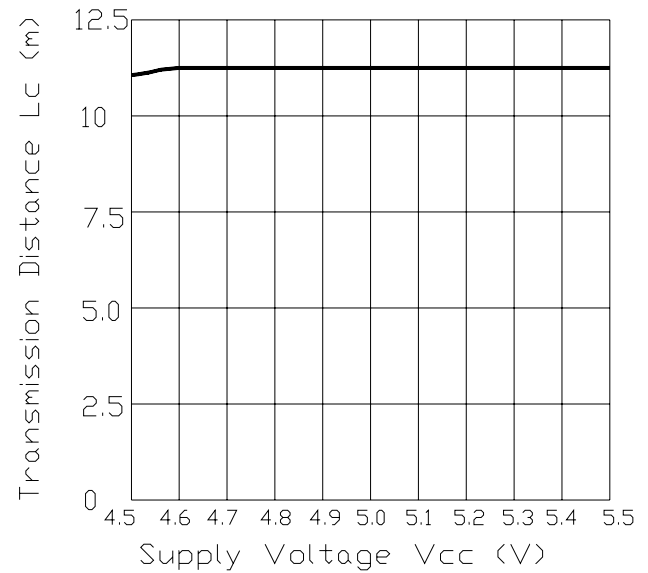

Fig.-7 Arrival Distance vs. Supply Voltage



**Typical Electro-Optical Characteristics Curves**

Fig.-8 Relative Transmission Distance vs. Center Carrier Frequency

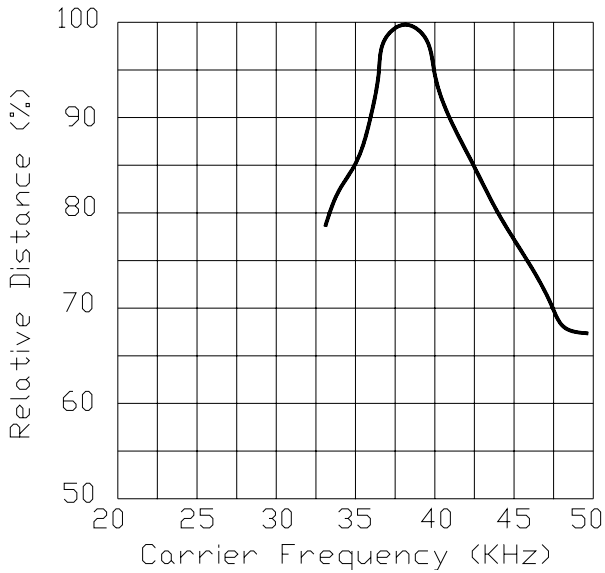
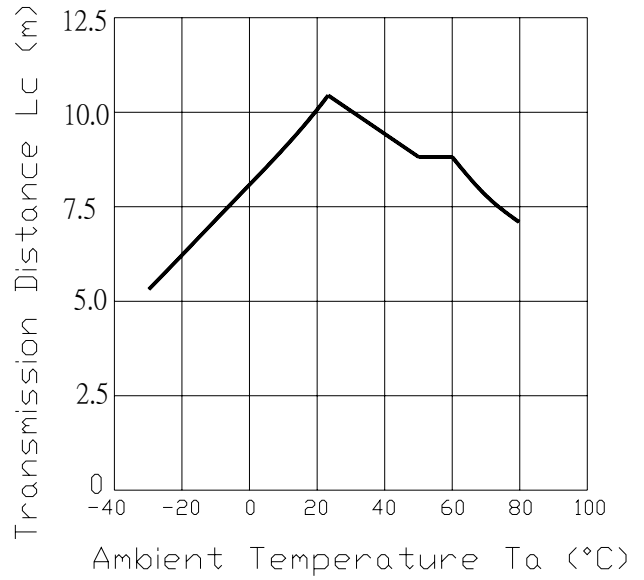

Fig.-9 Arrival Distance vs. Ambient Temperature



**Reliability Test Item And Condition**

The reliability of products shall be satisfied with items listed below.

Confidence level : 90%

LTPD : 10%



| Test Items                     | Test Conditions   | Failure Judgement Criteria  | Samples(n)<br>Defective(c) |
|--------------------------------|---|---|----------------------------|
| Temperature cycle              | 1 cycle -25°C ↔ +85°C<br>(30min)(5min)(30min)<br>300 cycle test | $L_0 \leq L \times 0.8$<br>$L_{45} \leq L \times 0.8$<br><br>L: Lower specification limit | n=22,c=0                   |
| High temperature test          | Temp: +85°C<br>Vcc:5V<br>1000hrs                                |   | n=22,c=0                   |
| Low temperature storage        | Temp: -40°C<br>1000hrs  |   | n=22,c=0                   |
| High temperature High humidity | Ta: 85°C,RH:85%<br>1000hrs                                      |   | n=22,c=0                   |
| Solder heat                    | Temp: 260±5°C 10sec<br>4mm From the bottom of the package.      |   | n=22,c=0                   |



**Packing Quantity Specification**

1. 1000 PCS/1Box
2. 10 Boxes/1Carton

**Label Form Specification**

|   |      |
|---|------|
| <b>EVERLIGHT</b>  |      |
| CPN:  |      |
| P/N:  |      |
|  |      |
| IRM-8755  |      |
| QTY:  | CAT: |
|  |      |
| LOT NO: EL  | HUE: |
|   | REF: |

CPN: Customer's Production Number

P/N : Production Number

QTY: Packing Quantity

CAT: Ranks

HUE: Peak Wavelength

REF: Reference

LOT No: Lot Number

**Notes**

1. Above specification may be changed without notice. EVERLIGHT will reserve authority on material change for above specification.
2. When using this product, please observe the absolute maximum ratings and the instructions for using outlined in these specification sheets. EVERLIGHT assumes no responsibility for any damage resulting from use of the product which does not comply with the absolute maximum ratings and the instructions included in these specification sheets.
3. These specification sheets include materials protected under copyright of EVERLIGHT corporation. Please don't reproduce or cause anyone to reproduce them without EVERLIGHT's consent.

**EVERLIGHT ELECTRONICS CO., LTD.***Office: No 25, Lane 76, Sec 3, Chung Yang Rd,  
Tucheng, Taipei 236, Taiwan, R.O.C**Tel: 886-2-2267-2000, 2267-9936**Fax: 886-2267-6244, 2267-6189, 2267-6306**http://www.everlight.com*