

PG-75 COMPACT PRESSURE GAUGE Series



**Compact, lightweight and multi-functional
general-purpose pressure gauge.**

COPAL ELECTRONICS
All for dreams



COMPACT PRESSURE GAUGE

PG-75 Series

It is a compact sensor module equipped with SUS316L stainless steel diaphragm, A digital temperature compensating circuit is adopted. It achieves compact and lightweight, high accuracy and high corrosion resistance. A large-sized LED display easy to see in a dark place (2-color change, 3 1/2 digit), to support maximum of 3.5 MPa. The small pressure gauge with excellent capability in visibility and in functionality is born.

Features

- Compact, lightweight and multi-functional general-purpose pressure gauge.
- It is adopted welding integral structure with SUS304/316L at pressure receiving section.
- A pressure display function is substantial. (3 1/2 digit, 7 segment LED, 2-color LED red / green change, Non-display mode)
- Two types of analog output, one is voltage output (1-5V), The other is current output (4-20mA).
- The gage pressure is (0~positive pressure), compound pressure range (negative pressure ~ positive pressure), to support maximum of 3.5 MPa.
- Comply with IP65, CE Marking and UL certification obtained.

Model Numbre Designation

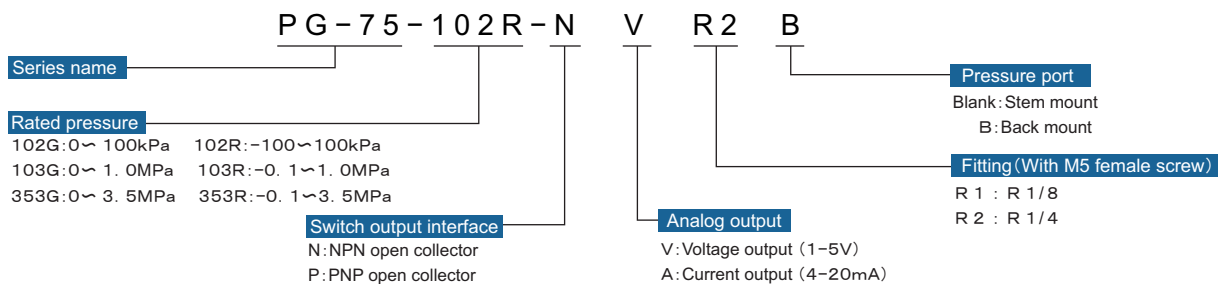

List Of Model Numbers

Pressure port	Fitting	SW output	Analog output	Pressure range (Rated range analog output)					
				(0~100 kPa)	(-100~100 kPa)	(0~1.0MPa)	(-0.1~1.0MPa)	(0~3.5MPa)	(-0.1~3.5MPa)
Stem	R1/8	NPN	1~5V	⇒ PG-75-102G-NVR1	⇒ PG-75-102R-NVR1	⇒ PG-75-103G-NVR1	⇒ PG-75-103R-NVR1	⇒ PG-75-353G-NVR1	⇒ PG-75-353R-NVR1
			4~20mA	⇒ PG-75-102G-NAR1	⇒ PG-75-102R-NAR1	⇒ PG-75-103G-NAR1	⇒ PG-75-103R-NAR1	⇒ PG-75-353G-NAR1	⇒ PG-75-353R-NAR1
		PNP	1~5V	⇒ PG-75-102G-PVR1	⇒ PG-75-102R-PVR1	⇒ PG-75-103G-PVR1	⇒ PG-75-103R-PVR1	⇒ PG-75-353G-PVR1	⇒ PG-75-353R-PVR1
			4~20mA	⇒ PG-75-102G-PAR1	⇒ PG-75-102R-PAR1	⇒ PG-75-103G-PAR1	⇒ PG-75-103R-PAR1	⇒ PG-75-353G-PAR1	⇒ PG-75-353R-PAR1
	R1/4	NPN	1~5V	⇒ PG-75-102G-NVR2	⇒ PG-75-102R-NVR2	⇒ PG-75-103G-NVR2	⇒ PG-75-103R-NVR2	⇒ PG-75-353G-NVR2	⇒ PG-75-353R-NVR2
			4~20mA	⇒ PG-75-102G-NAR2	⇒ PG-75-102R-NAR2	⇒ PG-75-103G-NAR2	⇒ PG-75-103R-NAR2	⇒ PG-75-353G-NAR2	⇒ PG-75-353R-NAR2
		PNP	1~5V	⇒ PG-75-102G-PVR2	⇒ PG-75-102R-PVR2	⇒ PG-75-103G-PVR2	⇒ PG-75-103R-PVR2	⇒ PG-75-353G-PVR2	⇒ PG-75-353R-PVR2
			4~20mA	⇒ PG-75-102G-PAR2	⇒ PG-75-102R-PAR2	⇒ PG-75-103G-PAR2	⇒ PG-75-103R-PAR2	⇒ PG-75-353G-PAR2	⇒ PG-75-353R-PAR2
Back	R1/8	NPN	1~5V	⇒ PG-75-102G-NVR1B	⇒ PG-75-102R-NVR1B	⇒ PG-75-103G-NVR1B	⇒ PG-75-103R-NVR1B	⇒ PG-75-353G-NVR1B	⇒ PG-75-353R-NVR1B
			4~20mA	⇒ PG-75-102G-NAR1B	⇒ PG-75-102R-NAR1B	⇒ PG-75-103G-NAR1B	⇒ PG-75-103R-NAR1B	⇒ PG-75-353G-NAR1B	⇒ PG-75-353R-NAR1B
		PNP	1~5V	⇒ PG-75-102G-PVR1B	⇒ PG-75-102R-PVR1B	⇒ PG-75-103G-PVR1B	⇒ PG-75-103R-PVR1B	⇒ PG-75-353G-PVR1B	⇒ PG-75-353R-PVR1B
			4~20mA	⇒ PG-75-102G-PAR1B	⇒ PG-75-102R-PAR1B	⇒ PG-75-103G-PAR1B	⇒ PG-75-103R-PAR1B	⇒ PG-75-353G-PAR1B	⇒ PG-75-353R-PAR1B
	R1/4	NPN	1~5V	⇒ PG-75-102G-NVR2B	⇒ PG-75-102R-NVR2B	⇒ PG-75-103G-NVR2B	⇒ PG-75-103R-NVR2B	⇒ PG-75-353G-NVR2B	⇒ PG-75-353R-NVR2B
			4~20mA	⇒ PG-75-102G-NAR2B	⇒ PG-75-102R-NAR2B	⇒ PG-75-103G-NAR2B	⇒ PG-75-103R-NAR2B	⇒ PG-75-353G-NAR2B	⇒ PG-75-353R-NAR2B
		PNP	1~5V	⇒ PG-75-102G-PVR2B	⇒ PG-75-102R-PVR2B	⇒ PG-75-103G-PVR2B	⇒ PG-75-103R-PVR2B	⇒ PG-75-353G-PVR2B	⇒ PG-75-353R-PVR2B
			4~20mA	⇒ PG-75-102G-PAR2B	⇒ PG-75-102R-PAR2B	⇒ PG-75-103G-PAR2B	⇒ PG-75-103R-PAR2B	⇒ PG-75-353G-PAR2B	⇒ PG-75-353R-PAR2B

The products marked ⇒ are manufactured upon receipt of order basis.

CE marking
Compatible with
EMC directive



Standard Specification

Model number	PG-75						
	102 G	103 G	353 G	102R	103R	353R	
Pressure reference		Gauge pressure			Gauge pressure (Compound)		
Rated pressure	Pr(L) ~ Pr(H)	0 ~ 100kPa	0 ~ 1.0MPa	0 ~ 3.5MPa	-100 ~ 100kPa	-0.1 ~ 1.0MPa	-0.1 ~ 3.5MPa
Maximum pressure	Pmax	200kPa	2MPa	5MPa	200kPa	2MPa	5MPa
Break-down pressure	Pb	300kPa	3MPa	7MPa	300kPa	3MPa	7MPa
Full-scale	FS	100kPa	1MPa	3.5MPa	200kPa	1.1MPa	3.6MPa
Pressure Medium		Corrosive gases/Liquids compatible with SUS304 or SUS316					
Sealed liquid		Silicone oil					
Operating voltage	Vopr	10.8 ~ 30VDC (Including ripple percentage)					
Consumption current		50mA maximum (Not included current analog output)					
Switch output	Number of outputs	Two outputs (NPN/PNP)					
	Switching capacity	30VDC / 100mA maximum					
	Residual voltage	1.2V maximum (NPN) / 2.2V maximum (PNP), Load current 100mA					
	Hysteresis	0 ~ Approx 0.3Pr(H), (Adjustable)					
	Repeatability	±0.3 %FS / Reference temp. 25°C					
	Accuracy	±2%FS (Integrated accuracy: Including errors of setting, linearity, hysteresis and thermal error.					
	Response	Approx 2.5 ms (Digital filter settings : "F0")					
	Protection	Exists / Short circuit protection (Switch Overload current detection : Approx 150mA minimum)					
	State indication	SW monitor LED (2 points), Lighted when the switch output is ON. (Pressure display inverted colors)					
Analog output		Voltage output/ Current output (Model selection)					
Voltage output	Vo	1 ~ 5V / Pr(L) ~ Pr(H), FS : 4V					
	Accuracy	±2%FS (Integrated accuracy) / Measurement load resistance (1MΩ maximum)					
	Resolution	Approx 2.7mV (11bit DAC)					
	Output resistance	Approx 1kΩ (Internal impedance)					
	Response	Approx 2ms maximum					
Current output	Io	4 ~ 20mA / Pr(L) ~ Pr(H), FS : 16mA					
	Accuracy	±2%FS (Integrated accuracy) / Measurement load resistance (250Ω maximum)					
	Resolution	Approx 0.01mA (11bit DAC)					
	Output resistance	Vopr ≤ 18VDC : 50 ~ 300Ω, Vopr > 18VDC : 50 ~ 500Ω					
	Response	Approx 2ms maximum					
Pressure display	Display element	3 1/2 digits, 7 segment LED (Red/Green) Reverse display selectable in tandem with SW1.					
	Display cycle	5 times /sec (moving average)					
	Accuracy	±2%FS (Integrated accuracy)					
Environmental characteristics	Protection grade	IP65 of IEC					
	Operating temp.	-10 ~ 50°C (Storage Temperature : -20 ~ 70°C)					
	Operating humidity	35 ~ 85%RH					
	Insulation resistance	100MΩ minimum at DC500V between bundled leads and pressure port					
	Dielectric strength	One minute at AC500V between bundled leads and pressure port (1mA maximum leakage)					
	Vibration	10 ~ 500Hz 1.5mm maximum / 98.1m/s ² , three directions, two hours each					
	Shock	490m/s ² , three directions, three times each					
Fitting port types		R1 (R1/8), R2 (R1/4)					
Fitting materials		Diaphragm: SUS316L, Fitting: SUS304					
Net Weight		Approx. 115 ± 15g (incl. 2m cable)					
Accessories		Nothing					

Output Electrical Schematics (Example: PG-75-102R-xxR2)

■-NV/NA

Two NPN outputs and (Voltage/Current) output

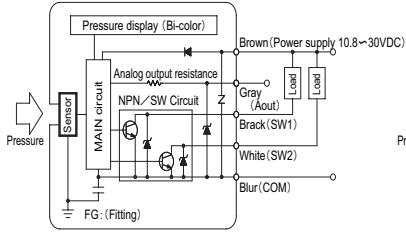

■-PV/PA

Two PNP outputs and (Voltage/Current) output

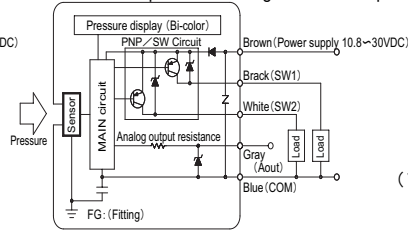

Panel Function

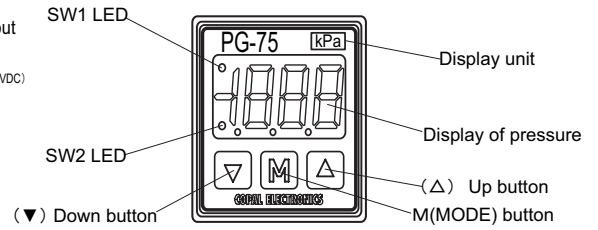

Operating Procedure

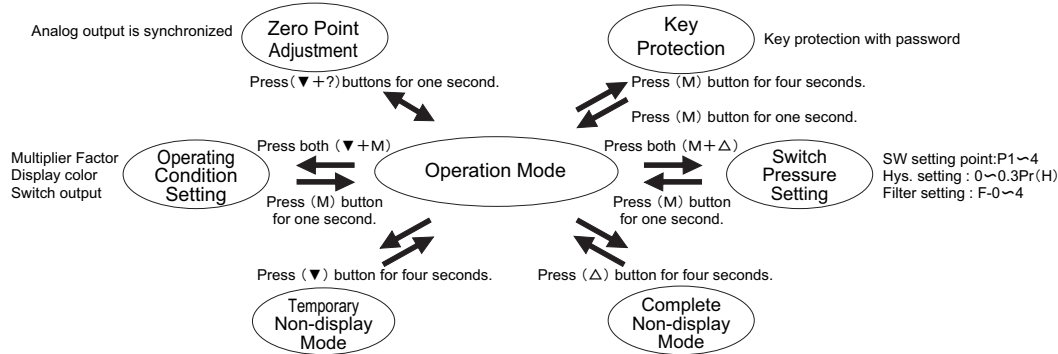

Operating Condition Setting

Setting operating conditions.

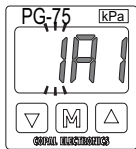

Press ▼ and (M) button simultaneously for more than one second to enter Operation Condition Setting Mode. The current setting condition is displayed. The third digit will flash. Then select setting using ▼ or ? button.

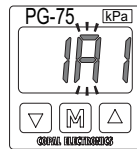

Press (M) button to move to the next digit. The next digit will flash and setting items will be changed.

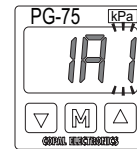

After completing the setting, press (M) button, for more than one second to save the setting and return to the Operation Mode.

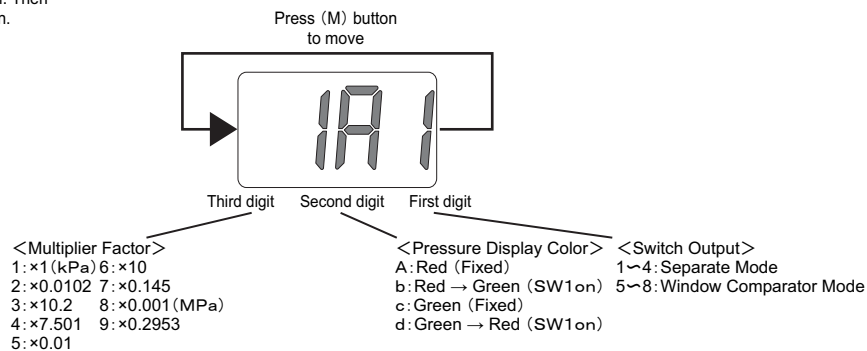

Multiplier Factor

The multiplier factor is selectable by changing the value of third digit on the display during the operation setting.

Code/ Multiplier Factor	Pressure Range / Display specification rated pressure					
	102G	102R	103G	103R	353G	353R
1: ×1 (kPa)	0.0 ~ 100.0	-100.0 ~ 100.0	0 ~ 1000	-100 ~ 1000	-	-
2: ×0.0102	.000 ~ 1.020	-1.020 ~ 1.020	0.00 ~ 10.20	-1.02 ~ 10.20	0.0 ~ 35.7	-1.0 ~ 35.7
3: ×10.2	0 ~ 1020	-1020 ~ 1020	-	-	-	-
4: ×7.501	0 ~ 750	-750 ~ 750	-	-	-	-
5: ×0.01	.000 ~ 1.000	-1.000 ~ 1.000	0.00 ~ 10.00	-1.00 ~ 10.00	0.0 ~ 35.0	-1.0 ~ 35.0
6: ×10	0 ~ 1000	-1000 ~ 1000	-	-	-	-
7: ×0.145	0.0 ~ 14.5	-14.5 ~ 14.5	0.0 ~ 145.0	-14.5 ~ 145.0	0 ~ 508	-15 ~ 508
8: ×0.001 (MPa)	-	-	.000 ~ 1.000	-100 ~ 1.000	0.00 ~ 3.50	-0.10 ~ 3.50
9: ×0.2953	0.0 ~ 29.5	-29.5 ~ 29.5	0 ~ 295	-30 ~ 295	0 ~ 1033	-30 ~ 1033

- The settings indicated by "-" on the table above are not selectable because of resolution.
- Either "1" (for 102A, 102V, 102G, and 102R) or "8" (for 103G, 103R, 353G and 353R) are set prior to delivery.
- Changes of the multiplier factor apply to display values. Also, note the changes reset switch setting value and hysteresis.

Display Color

The display color is selectable by changing the value of second digit on the display during the operation setting.

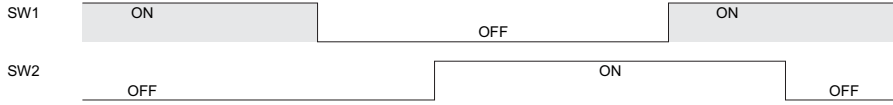

Code	Change of Display Color		
A			Red
b	Green		Green
c		Green	
d	Red	Green	Red

- The change of display color applies to SW1 operation only.
- The factory setting is "A" (Always red)
- Values other than pressure value (SW monitor, setting display, error messages etc) are displayed in opposite color of the pressure value (Red/Green).

Switch Output

SW output is selectable by changing the value of first digit on the display.

Output	<SW Operation Code>				<Switch Operation Mode>			
	SW1		SW2		Separate Mode		Window Comparator Mode	
Mode	Separate	Window comparator	Separate	Window comparator	(HI operation)	(A operation)	(LO operation)	(B operation)
Operation	HI LO	A B	HI LO	A B	OFF ON	ON OFF	ON OFF	OFF ON
1	○		○		○	○	○	○
2	○		○		○	○	○	○
3		○		○	○	○	○	○
4		○		○	○	○	○	○
5		○		○	○	○	○	○
6		○		○	○	○	○	○
7		○		○	○	○	○	○
8		○		○	○	○	○	○
Pressure setting	Set 1	(Minimum) Set 1 (Maximum) Set 3	Set 2	(Minimum) Set 2 (Maximum) Set 4	$P1 \leq P2$ or $P1 \geq P2$ $P1 \leq P3-2H$ and $P2 \leq P4-2H$ H: Hysteresis, P1=Set 1, P2=Set 2, P3=Set 3, P4=Set 4			

- In the Separate mode, SW 1 corresponds to Setting 1 and SW2 corresponds to Setting 2.
- In the Window Comparator Mode, SW 1 corresponds to the Setting 1 (lower limit) and Setting 3 (upper limit). Also, SW2 corresponds to the setting 2 (lower limit) and setting 4 (upper limit).
- The Hysteresis (H) setting is common to SW 1 and SW 2 operations.
- When SW operation is changed between the Separate Mode and Window Comparator Mode, SW pressure settings that are set separately will be reset.

Switch Pressure Setting

This mode is for setting SW setting value, Hysteresis, and Digital filter. To return to the operation mode during the setting, press (M) button more than one second. The setting will be saved. When the setting of either the multiplier factor or switch operation mode is changed, the setting of switch pressure will be reset.

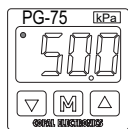

During the Operation Mode, press (M) and Δ buttons for more than one second to enter SW Pressure Setting Mode. The SW1 LED flashes. The display color will be reversed and the current SW1 setting value will be displayed. Set the switch value using ∇ and Δ buttons. SW pressure setting range: -110kPa or -0.11 Pr (H) \sim -1.1Pr (H) (whichever range is narrower)

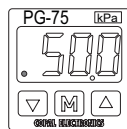

Press (M) button once. The SW2 LED will flash. The current SW2 setting value will be displayed. Set the switch value using ∇ and Δ buttons.

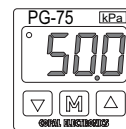

(Only when the Window Comparator Mode is set) Press (M) button once. The display color will be reversed and the SW1 LED will flash and the current value of P3 will be displayed. Set the P3 value in the same manner. Note P3 and P4 setting ranges are influenced by Hysteresis (H). See Switch Operation Mode table for the details.

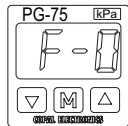

Press (M) button once. Both SW1 and SW2 LEDs will turn off and the Digital filter setting will be displayed. Set the value in the same manner. Response time: (F-0, 1, 2, 3) : (2.5, 25, 250, 1000, 2000)ms F-0 (2.5ms) is set prior to delivery.

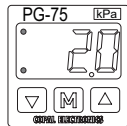

Press (M) button once. The display color will get back to the original color and both SW1 and SW2 LEDs will flash. The current Hysteresis (H) value will be displayed. Set the value using ∇ and Δ buttons. Hysteresis setting range: 0 \sim approximately 0.3Pr (H)



(Only when the Window Comparator Mode is set) Press (M) button once again. The SW2 LED will flash and the current value of P4 will be displayed. Set the P4 value in the same manner.

Zero Point Adjustment

This function is for adjusting the zero point of pressure display and analog output when the pressure port is opened to the atmosphere.

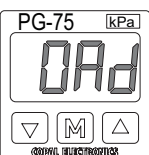

- During the operation mode, press ∇ and Δ buttons simultaneously for more than one second. Display of "0Ad" will blink. One second after releasing the ∇ and Δ buttons, the adjustment will be completed.
- If residue pressure remains in the pressure port and the pressure is more than $\pm 10\%$ of rated pressure, zero adjustment will be cancelled and "E-2" error message will be displayed. To cancel the error message, press (M) button and release the residue pressure. Then, adjust the zero point once again.
- In case of the 102A pressure range type, zero point adjustment is calibrated at absolute vacuum (0.3kPa abs max.) Therefore, zero adjustment is not necessary.

Key Protection

The Key Protection Mode is used to lock the front panel key in order to prevent setting values from been accidentally changed. Only the cancellation entry can be made.

- The Key Protection status is saved to the flash memory and maintained even after the power is turned off.

【Key Protection Mode】

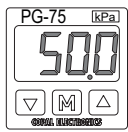

Press Δ button for more than four seconds during the Operation Mode. The display color will be reversed and "00" will be displayed

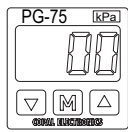

Two-digit numeric secret code is necessary. The code "00" does not require the entry of the code when canceling the protection.

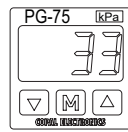

When a number from "01~99" is selected for the secret code, entry of the same code is required to cancel the protection. The code can be selected by ∇ and Δ buttons. To save the code, press (M) button.

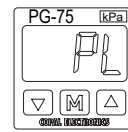

"PL" will be displayed and the key entry will be locked except for cancellation entry.

【Cancellation of Key Protection】

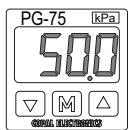

To cancel the protection, press Δ button for more than four seconds. The display color will be reversed and "00" will be displayed

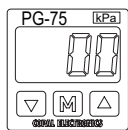

When a code from "01~99" is set, the code entry will be required.

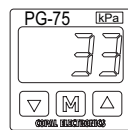

For example, select "33" and press (M) button. If the incorrect code is entered three times, the buttons will be locked again.

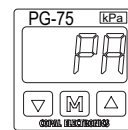

If the code is entered correctly, "PA" will be displayed and the buttons will be unlocked.

Temporary Non-display Mode

This mode is for temporarily turning off pressure display.

- When this mode is on, the pressure display automatically will turn off after 10 seconds if not used. When the display is turned off, the decimal LED will blink.
- If any error is detected during this mode, error message will be displayed. After the error is corrected, the Temporary Non-display Mode will resume.
- Any key entry for other settings will be accepted in this mode. Even after the display turns on again, this mode will last until it is cancelled.
- If the Full Time Non-display Mode (as explained later) is set during this Temporary Non-display Mode, the system will be switched to the Full Time Non-display Mode.
- The setting data of this mode is stored to flash memory and will not be lost even after the power is turned off.

【Setting and Canceling of Temporary Non-display Mode】



Press ∇ button for more than four seconds during the normal operation.

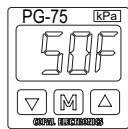

The display color will be reversed and "50F" will be displayed. At this stage, normal pressure display will be displayed

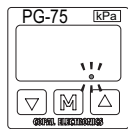

If there is no key operation for more than 10 seconds, the pressure display will go off and the decimal LED will blink.

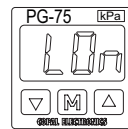

To cancel this mode, Press ∇ button for more than four seconds. The display color will be reversed and "LO n" will be displayed. Then the product will get back to the normal operation.

Complete Non-display Mode

This mode is for constantly turning off pressure display.

- When this mode is on, the pressure display will be turned off and will not accept any key operation except the cancellation operation. The decimal LED will be on.
- If any error is detected during this mode, error message will be displayed. After the error is corrected, the Complete Non-display Mode will resume.
- Any key entry for other settings will not be accepted during this mode.
- The setting data of this mode is stored to flash memory and will not be lost even after the power is turned off.

【Setting and Canceling of Complete Non-display Mode】

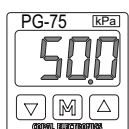

Press (M) button for more than four seconds during the normal operation

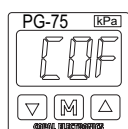

The display color is reversed and "COF" will be displayed. Then, the display will be turned off.

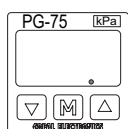

The decimal LED will light.

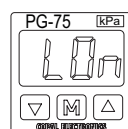

To cancel the mode, press (M) button for more than four seconds. The display color will be reversed and "LO n" will be displayed. Then the product will get back to the normal operation.

Troubleshooting

If an error occurs, please refer to the table as below and follow the procedures.

Error Display/Description	Problem	Solution
E 1	Current Overloaded on SW. Both SW1 and SW2 are off. (Flashing LED indicates excessive current on SW1 or SW2.)	Turn off the power and check the load connected to SW1 and/or SW2.
E 2	Pressure more than +/- 10% of the rated pressure is applied during the zero point adjustment.	Press (M) button to cancel the error display. Release the residue pressure and then make the zero point adjustment again.
Black out of pressure display	During the operation mode, key entry is possible. However, pressure display blacks out and the decimal LED blinks.	It is a normal state and the product is in the Temporary Non-Display Mode. In order to cancel the mode, press ▼ button for more than four seconds.
Black out of pressure display and no key entry possible	Even though the power is on, key entry is not possible. Also, pressure display blacks out and the decimal LED lights.	It is a normal state and the product is in the Full Time Non-Display Mode. In order to cancel the mode, press (M) button for more than four seconds.
No key entry possible	During the operation mode, key entry is not possible even though the pressure value is displayed.	It is a normal state and the product is in the Key Protection Mode. In order to cancel the mode, press △ button for more than four seconds. If the secret code is set, the code entry is necessary.

Externals specification (unit:mm)

Vertical installation type

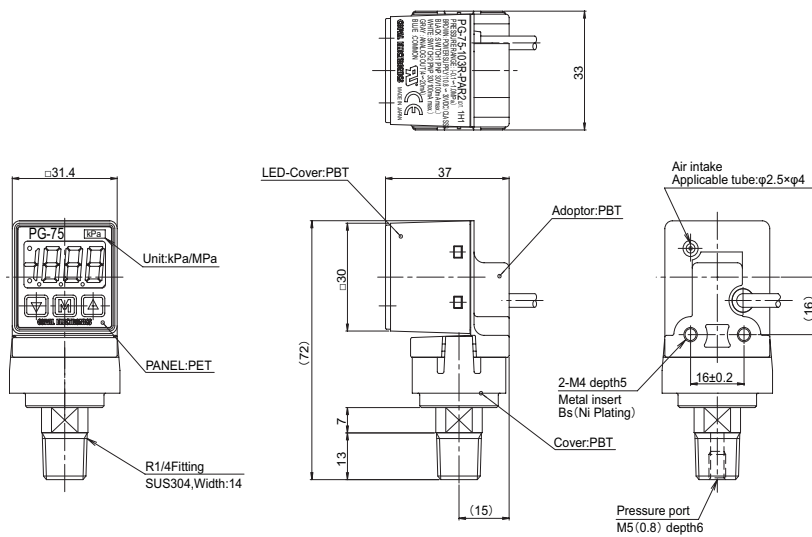

The horizontal installation type

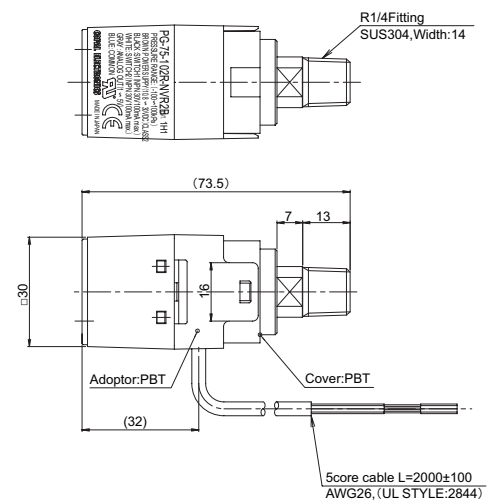

Means of attachment (Option)

Vertical installation type

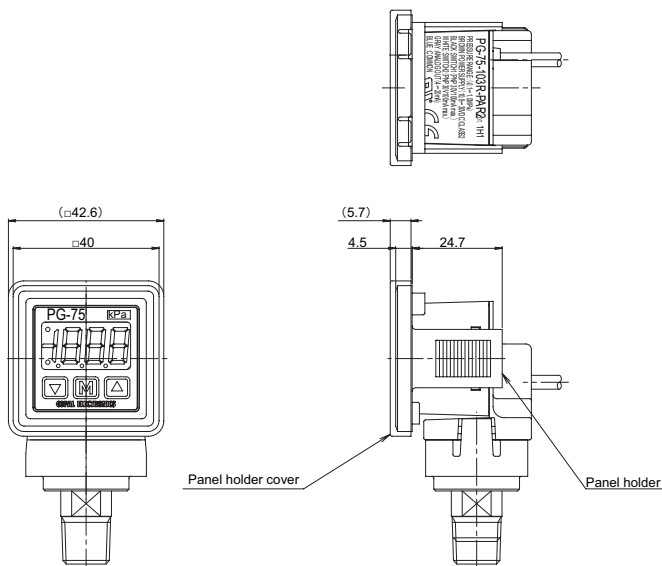

The horizontal installation type

