

SPECIFICATIONS

CONTACT RATING: 1A @120 VAC or 28 VDC
 ELECTRICAL LIFE: 50,000 make-and-break cycles at full load
 CONTACT RESISTANCE: 20 mΩ max. initial @2-4 VDC, 100 mA
 INSULATION RESISTANCE: 1,000 MΩ min.
 DIELECTRIC STRENGTH: 1,000 V RMS @ sea level.
 OPERATING TEMPERATURE: -30°C to +85°C

MATERIALS

CASE - diallyl phthalate (DAP)
 PLUNGER - Glass filled nylon or glass filled polyester (UL94V-0)
 BUSHING - Copper alloy , nickel plated
 HOUSING - Stainless Steel
 CONTACT AND TERMINAL - Copper alloy, silver plated

How do you build the switches you need!!

The straight type, please see the (A);

The right angle P.C terminals, please see the (B)

(A) P 8 7 0 1 - C V 1 - 2 - C R - E - S 2 0 - -

Switches Function		Cap or Actuator		Cap color		Bushing			Epoxy seal		Vertical support Bracket	
P8701	SPDT on-mom	none	(none)	1	white	F	thd /key-way	7.37	E	epoxy seal	(none)	
P8702	DPDT on-mom	CV	5.08	2	black	N	non-thd /key-way	7.37			S20	11.68
		CV1	7.55	3	red	F4	thd /key-way	6.35			V20	snap-in 11.68
		CV2	9.53	4	orange	N4	non-thd /key-way	6.35				
		CV4	dress nut	5	yellow	E	thd /key-way	8.89				
		F22A	With frame	6	green	F8	thd /flat	7.37				
		F32A	With frame and LED	7	blue	N8	non-thd /flat	7.37				
				8	brown	F9	thd /flat	6.35				
				9	gray	N9	non-thd /flat	6.35				

Termination	
B	solder lug
C	P.C 1.27width
D	Quick connect

Contact Material	
Q	silver plated
R	gold plated
G	gold over silver

Rubber hood	
E4	for thd. bushing

RoHS code	
<input type="checkbox"/>	= none
H	= RoHS Compliant

(B) P 8 7 0 1 - A 4 - C V 1 - 2 - R - E - S -

Switches Function		Right Angle		Cap		Cap color		Bushing			Contact Material	
P8701	SPDT on-mom	A4	Horizon	none	(none)	1	white	F	thd /key-way	7.37	Q	silver plated
P8702	DPDT on-mom	A5	Vertical	CV	5.08	2	black	N	non-thd /key-way	7.37	R	gold plated
				CV1	7.55	3	red	F4	thd /key-way	6.35	G	gold over silver
				CV2	9.53	4	orange	N4	non-thd /key-way	6.35		
						5	yellow	E	thd /key-way	8.89		
						6	green	F8	thd /flat	7.37		
						7	blue	N8	non-thd /flat	7.37		
						8	brown	F9	thd /flat	6.35		
						9	gray	N9	non-thd /flat	6.35		

Epoxy seal	
E	epoxy seal

Support Bracket	
(none)	std.
S	snap-in type

RoHS code	
<input type="checkbox"/>	= none
H	= RoHS Compliant

T80-P Snap Acting Momentary Pushbutton Switches



SPDT



Model No.	Switching position	
P8701	on	Mom
Term. Comm.	1-3	1-2

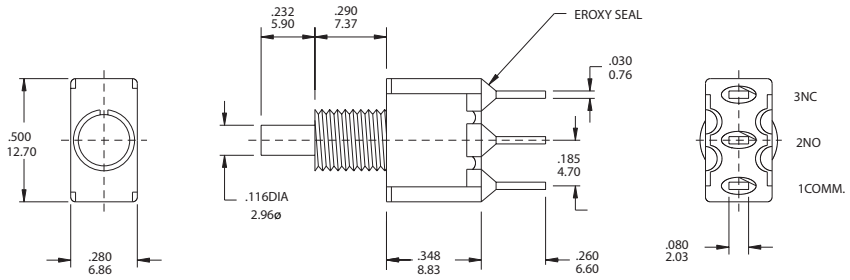
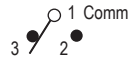

P8701-FBR-E

SPDT



Model No.	Switching position	
P8701-A4	on	Mom
Term. Comm.	1-3	1-2

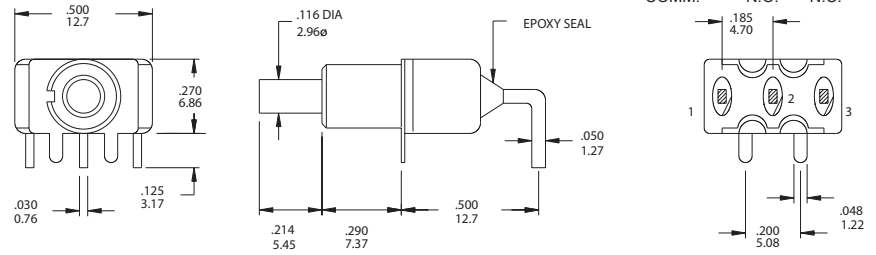

P8701-A4-NR-E

SPDT

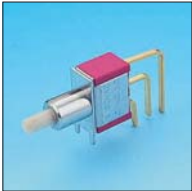

Model No.	Switching position	
P8701-A5	on	Mom
Term. Comm.	1-3	1-2

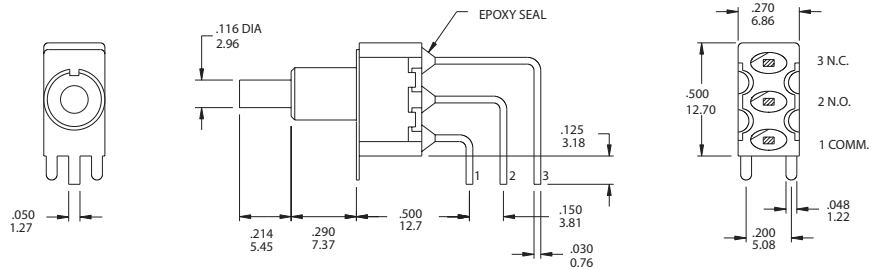
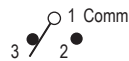

P8701-A5-NR-E

DPDT



Model No.	Switching position	
P8702	on	Mom
Term. Comm.	1-3 4-6	1-2 4-5

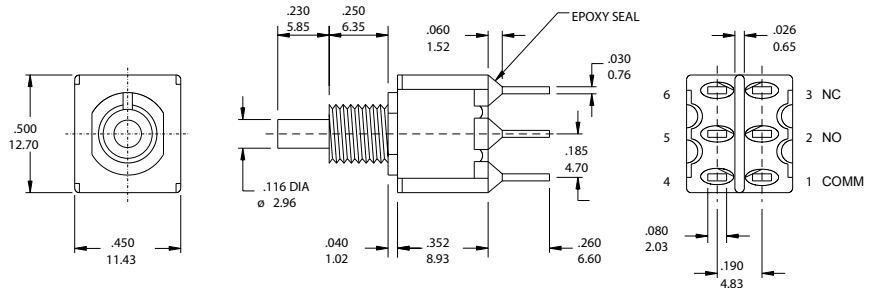

P8702-F4BR-E

DPDT



Model No.	Switching position	
P8702-A4	on	Mom
Term. Comm.	1-3 4-6	1-2 4-5

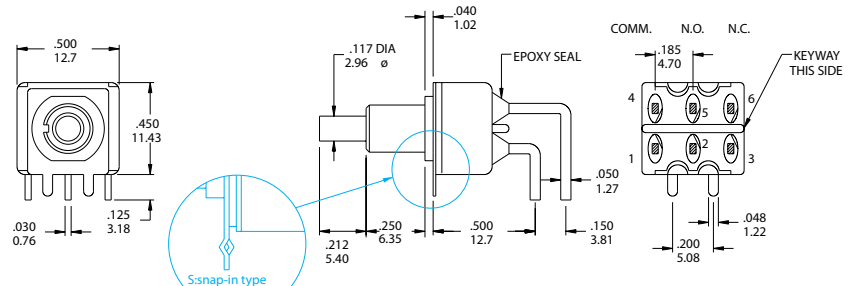

P8702-A4-N4R-E/ P8702-A4-N4R-E-S

DPDT



Model No.	Switching position	
P8702-A5	on	Mom
Term. Comm.	1-3 4-6	1-2 4-5

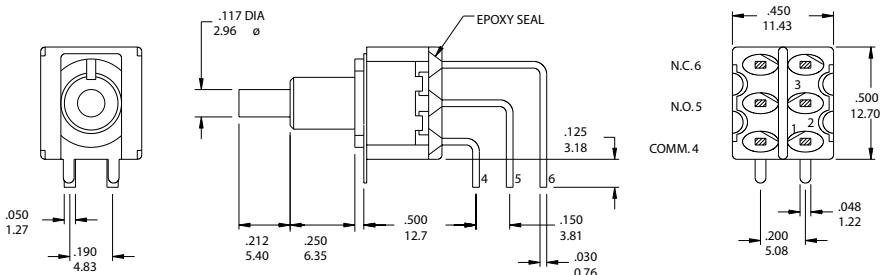

P8702-A5-N4R-E

Cap and Actuator Option

Cap color Option

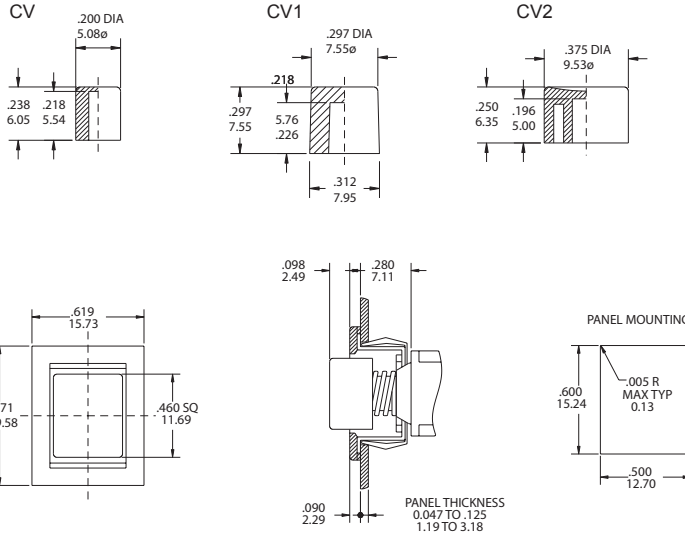

CAP & ACTUATOR OPTIONS	
1	White
2	Black(Std.)
3	Red
4	Orange
5	Yellow
6	Green
7	Blue
8	Brown
9	Gray

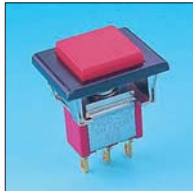

F22A

1212

P870X-F22A-X-BR-E

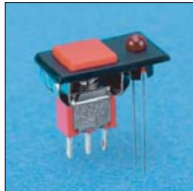

F32A

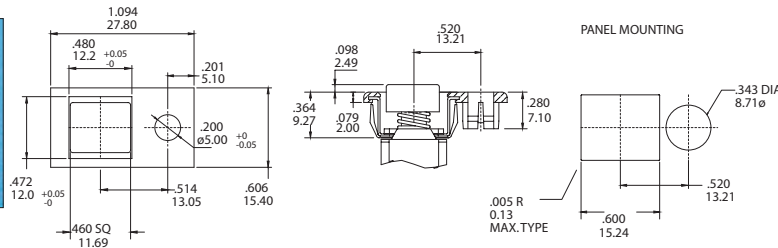

P870X-F32A-X-BQ-E

Panel Mounting

without lock ring

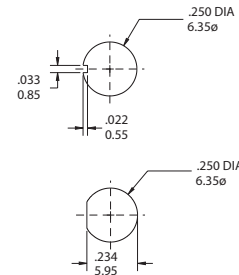

with lock ring

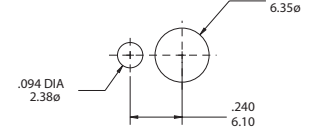

Bushing Option

F thd.
N non-thd.
(only for SPDT)

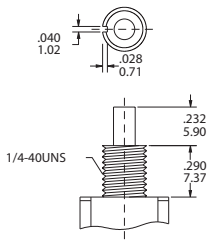

F4 thd.
N4 non-thd.

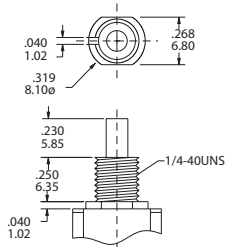

E thd.
(only for SPDT)

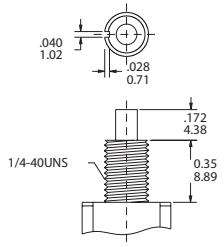

F8 thd.
N8 non-thd.
(only for SPDT)

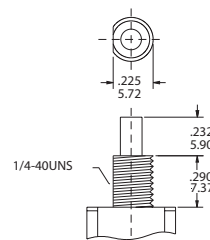

F9 thd.
N9 non-thd.

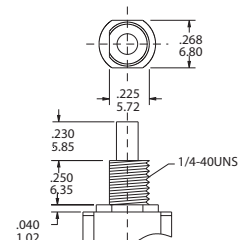

TERMINAL OPTION (ONLY FOR THE STRAGHT TYPE)

TERMINAL SEAL OPTION

RUBBER HOOD

B STD

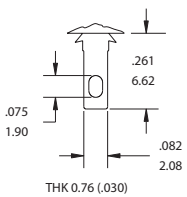

C PRINTED CIRCUIT

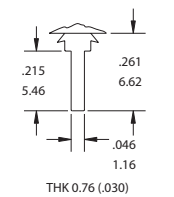

D QUICK CONNECT

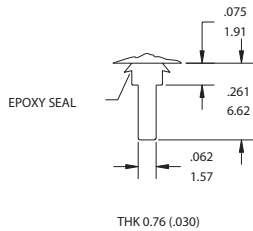

E TERMINAL SEAL

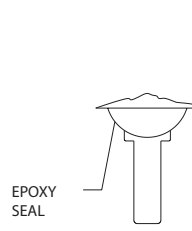

E4

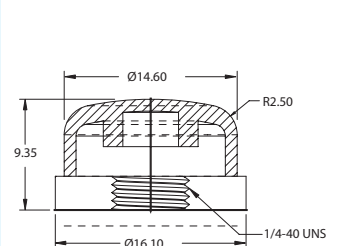

CONTACT MATERIAL OPTIONS

CODE	CONTACT MATERIAL	TERMINAL MATERIAL	RATING
Q	Silver plated	Silver plated	1A @ 120V AC or 28 V DC;
R	Gold plated over nickel plated	Gold plated over nickel plated	0.4 VA MAX@ 20V AC or DC MAX
G	Gold plated over silver plated	Gold plated over silver plated	0.4 VA MAX @ 20 V AC or DC MAX or 1 A @ 120V AC or 28 V DC;

VERTICAL SUPPORT BRACKET OPTION

(only apply the straight type terminal-Please modify the terminal option is "c" code)

S20/V20



SPDT

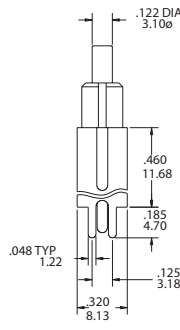
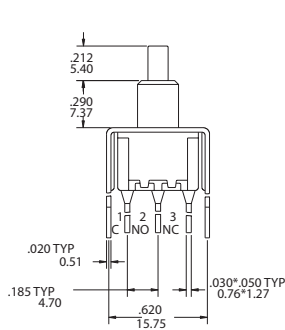

P.C. MOUNTING

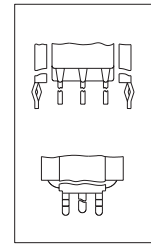
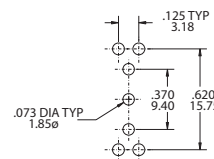

SNAP-IN
V 20

P8701-NCR-E-S20

S20/V20



DPDT

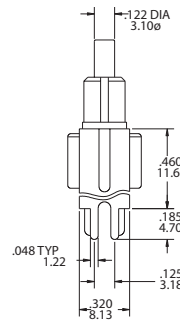
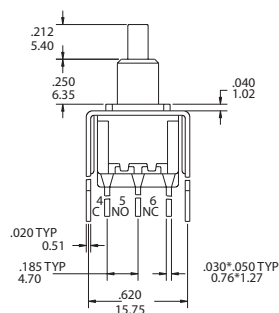

P.C. MOUNTING

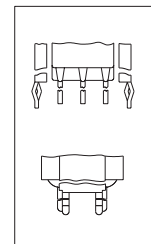
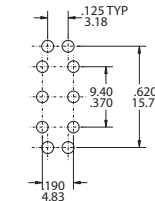

SNAP-IN
V 20

P8702-N4CR-E-S20

The hard ware of T80-P push button switches

The P.C.B mounting Dimension

NUT

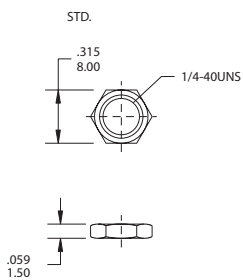

DRESS NUT

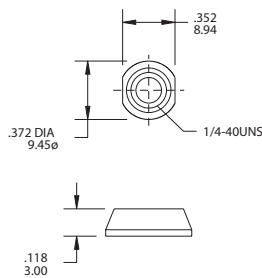

LOCK WASHER

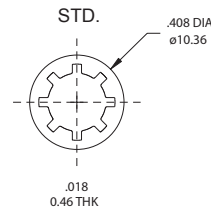

LOCKING RING

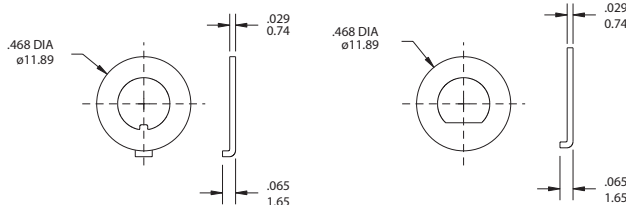

DRESS NUT & CAP

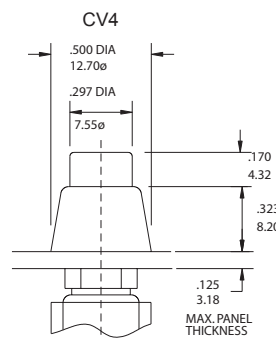

To order dress nut only.

P8701-A4

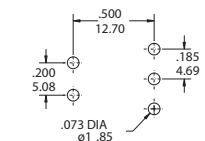

P8702-A4

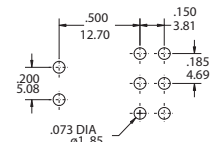

P8701-A5

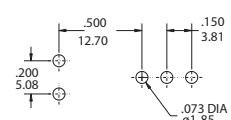

P8702-A5

