

Specifications

Current rating: 1A AC,DC

Voltage rating: 200V AC,DC

Temperature range: $-25^{\circ}\text{C} \sim +85^{\circ}\text{C}$

Contact resistance: $20\text{m}\Omega$ Max.

Insulation resistance: $100\text{M}\Omega$ Min.

Withstanding voltage: 500V AC/minute

Assembly layout

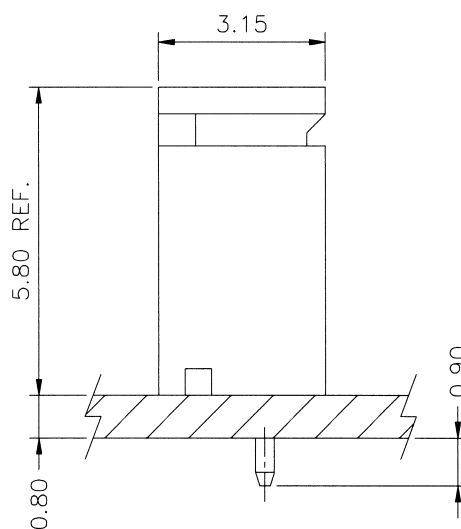
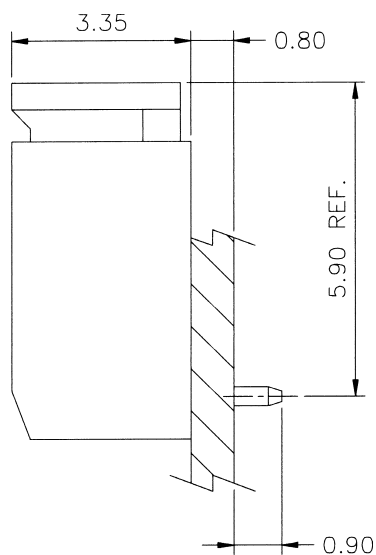

A1253-T

1.25mm pitch Crimp Terminal

Reference Informations:

*Used in CJT A1253 series Housing

*Tolerance:(unit:mm) .0 ±0.25/ .00 ±0.15/ .000 ±0.10

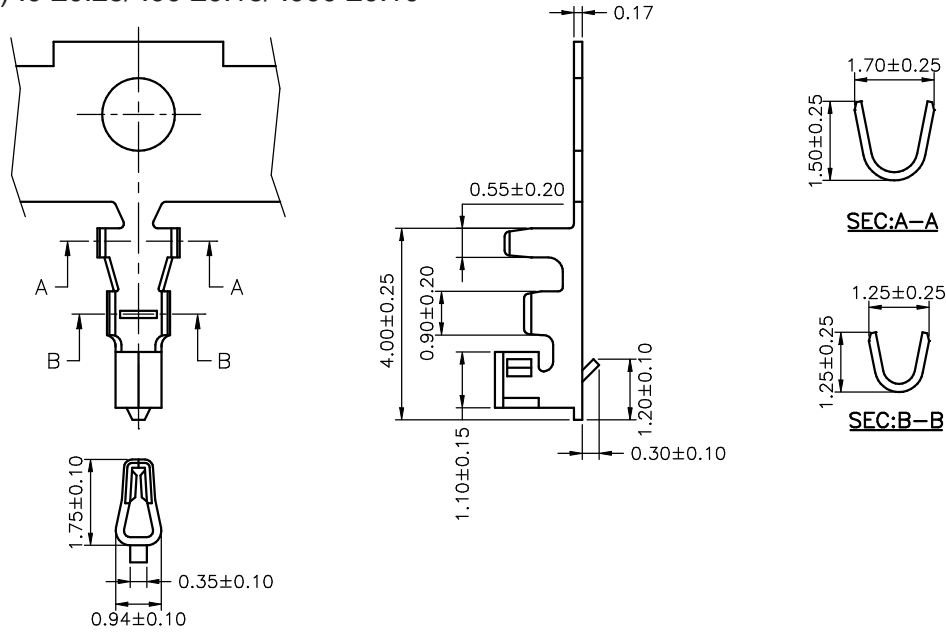

Ordering Information & Specifications:

Unit:mm

Part No.	Wire Range	Insulation O.D.	Material	Finish	Qty/reel
A1253-TP	AWG#28-#32	1.00mm(max)	Phosphor Bronze	Tin-plated	10,000pcs

A1253-H

1.25mm pitch Housing

Reference Informations:

*Material: Nylon 66,UL94V-0

*Suitable CJT A1253 series Terminal

*Mates with CJT A1253 series Wafer

*Tolerance:(unit:mm) .0 ±0.25/ .00 ±0.15/ .000 ±0.10

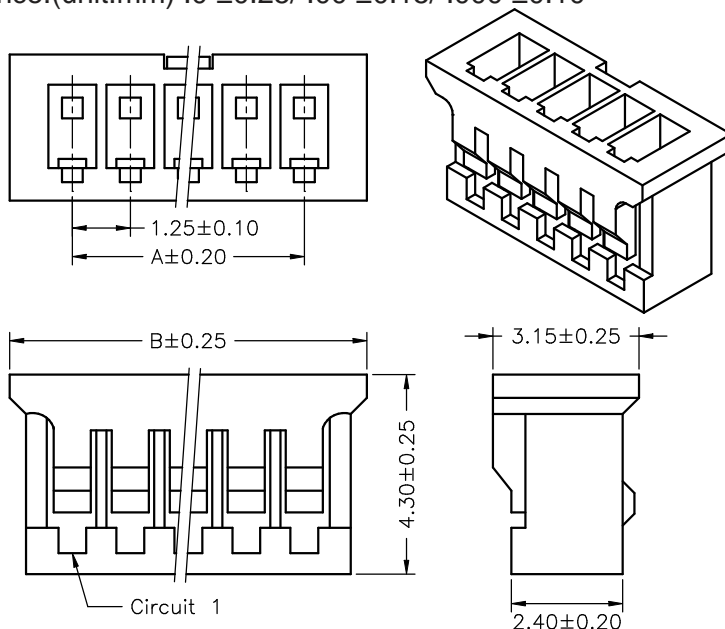

Ordering Information & Dimensions:

PART NO.	Dimensions	
	A	B
A1253H-2P	1.25	3.95
A1253H-3P	2.50	5.20
A1253H-4P	3.75	6.45
A1253H-5P	5.00	7.70
A1253H-6P	6.25	8.95
A1253H-7P	7.50	10.20
A1253H-8P	8.75	11.45
A1253H-9P	10.00	12.70
A1253H-10P	11.25	13.95
A1253H-11P	12.50	15.20
A1253H-12P	13.75	16.45
A1253H-13P	15.00	17.70
A1253H-14P	16.25	18.95
A1253H-15P	17.50	20.20

Unit:mm

A1253-WV

1.25mm pitch 180° Wafer

Reference Informations:

*Material: Pin: Brass/Tin-plated

Wafer: Nylon 66,UL94V-0

*Mates with CJT A1253 series Housing

*Tolerance:(unit:mm) .0 ±0.25/ .00 ±0.15/ .000 ±0.10

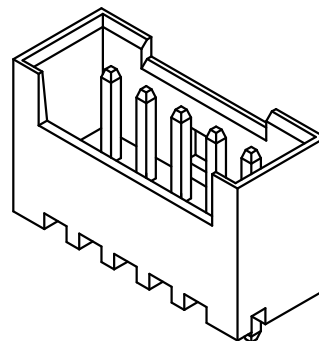
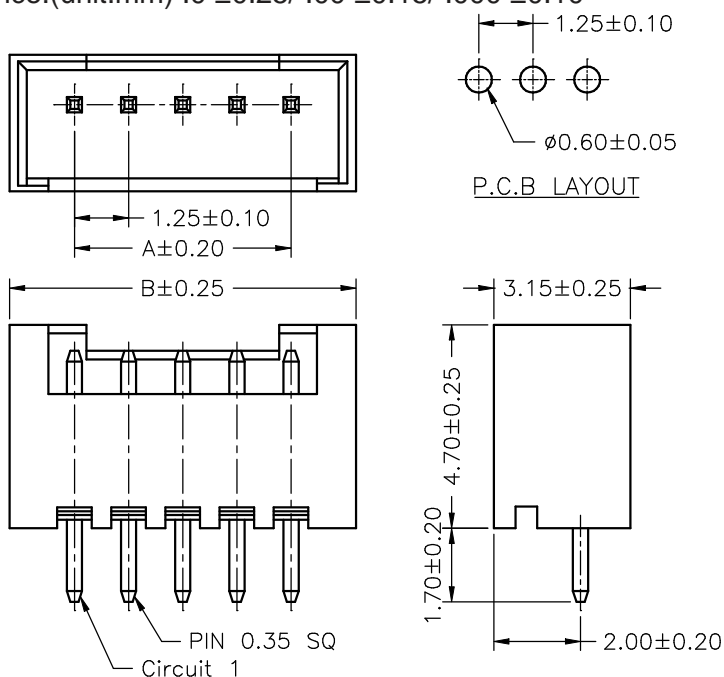

Ordering Information & Dimensions:

PART NO.	Dimensions	
	A	B
A1253WV-2P	1.25	4.25
A1253WV-3P	2.50	5.50
A1253WV-4P	3.75	6.75
A1253WV-5P	5.00	8.00
A1253WV-6P	6.25	9.25
A1253WV-7P	7.50	10.50
A1253WV-8P	8.75	11.75
A1253WV-9P	10.00	13.00
A1253WV-10P	11.25	14.25
A1253WV-11P	12.50	15.50
A1253WV-12P	13.75	16.75
A1253WV-13P	15.00	18.00
A1253WV-14P	16.25	19.25
A1253WV-15P	17.50	20.50

Unit:mm

A1253-WR

1.25mm pitch 90° Wafer

Reference Informations:

*Material: Pin: Brass/Tin-plated

Wafer: Nylon 66,UL94V-0

*Mates with CJT A1253 series Housing

*Tolerance:(unit:mm) .0 ±0.25/ .00 ±0.15/ .000 ±0.10

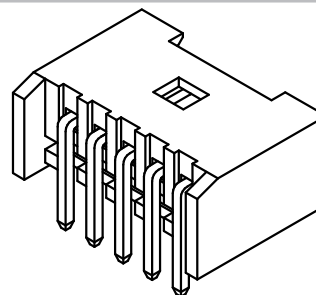
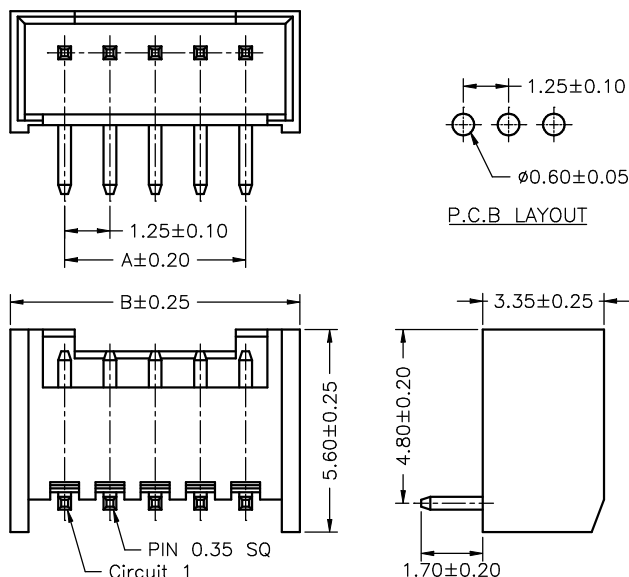

Ordering Information & Dimensions:

PART NO.	Dimensions	
	A	B
A1253WR-2P	1.25	4.25
A1253WR-3P	2.50	5.50
A1253WR-4P	3.75	6.75
A1253WR-5P	5.00	8.00
A1253WR-6P	6.25	9.25
A1253WR-7P	7.50	10.50
A1253WR-8P	8.75	11.75
A1253WR-9P	10.00	13.00
A1253WR-10P	11.25	14.25
A1253WR-11P	12.50	15.50
A1253WR-12P	13.75	16.75
A1253WR-13P	15.00	18.00
A1253WR-14P	16.25	19.25
A1253WR-15P	17.50	20.50

Unit:mm