

# TO-220 Power Resistor – TR20

## Construction

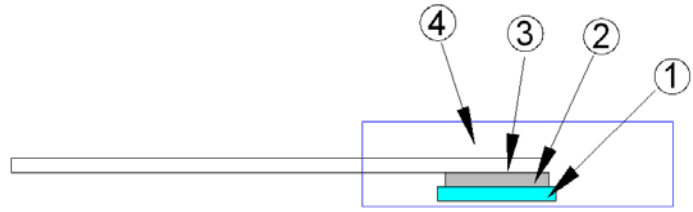

① Alumina Substrate	③ Lead
② Resistor Layer	④ Molding

## Features

- 20 Watts at 25°C case temperature heat sink mounted
- TO-220 style power package
- Molded case for protection and easy to mount
- Electrically isolated case
- Non-Inductive design

## Applications

- High Speed Switching Power Supplies
- Snubber Circuits
- Load Resistor for Pulse Generators
- Voltage Regulation
- VHF Amplifiers

## Dimensions

Unit: mm

Type	Weight (g) (1000pcs)
TR20	1290

## Electrical Characteristics Specifications

Item Type	Resistance Range				TCR (PPM/°C)
	±0.5%	±1%	±5%	±10%	
TR20	-	-	0.05Ω -1Ω		No Specified
	-	>1Ω -3Ω			±300
	-	>3Ω -10Ω			±100 ±200
	>10Ω -10KΩ				±50 ±100 ±200

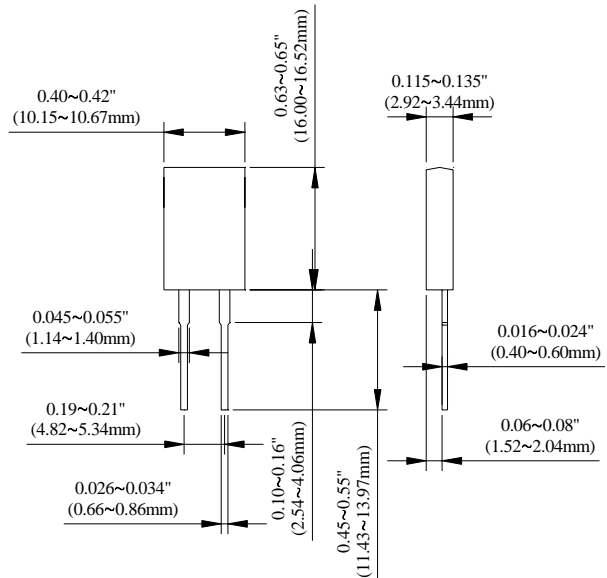

- Operating Voltage: 350V max.
- Dielectric Strength: 1800VAC
- Insulation Resistance: 10GΩ min.
- Working Temperature Range: -65°C to +150°C
- Resistance Value <1Ω is available

## Derating Curve

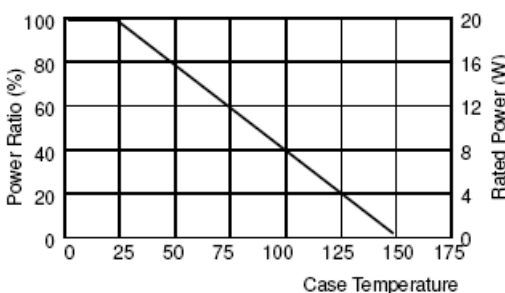

## Part Numbering

TR	20	J	B	D	1001
Product Type	Power	Resistance Tolerance	Packaging Code	TCR (PPM/°C)	Resistance
	20: 20 Watts	D: ±0.5% F: ±1% J: ±5% K: ±10%	B: Bulk	D: ±50 E: ±100 F: ±200 G: ±300 - : No Specified	R100: 0.1Ω 0100: 10Ω 4700: 470Ω 1001: 1000Ω 1002: 10000Ω

## ■ Environmental Characteristics

Test Item	Requirement	Test Method
Temperature Coefficient of Resistance (T.C.R.)	As Spec.	Referenced to 25°C, ΔR taken at +105°C
Short Time Overload	ΔR±0.3%	2 times rated power with applied voltage not to exceed 1.5 times Maximum continuous operating voltage for 5 seconds
Load Life	ΔR±1.0%	2,000 hours at rated power
Damp Heat with Load	ΔR±0.5%	40±2°C, 90~95% R.H. Max. working voltage for 1000 hrs with 1.5 hrs "ON" and 0.5 hrs "OFF"
Solderability	90% min. coverage	245±5°C for 3 seconds
Thermal Shock	ΔR±0.3%	-65°C~150°C, 100 cycles
Terminal Strength	ΔR±0.2%	(Pull Test) 2.4N
Vibration, High Frequency	ΔR±0.2%	20g peak

- Lead Material: Tinned Copper
- Without a Heat Sink
- When in Free Air at 25°C, the TR20 is Rated for 3W
- The Case Temperature is to be used for the Definition of the Applied Power Limit
- The Case Temperature Measurement must be made with a Thermocouple Contacting the Center of the Component mounted on the Designed Heat Sink.
- Thermal Grease should be Applied Properly

# TO-220 Power Resistor – TR30



## Construction

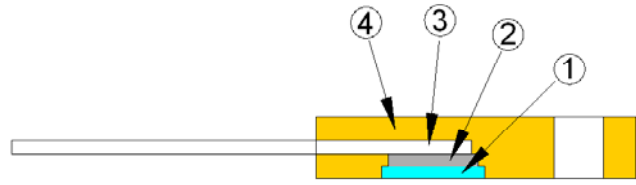

① Alumina Substrate	③ Lead
② Resistor Layer	④ Molding

## Features

- 30 Watts at 25°C case temperature heat sink mounted
- TO-220 style power package
- Single screw mounting to heat sink
- Molded case for protection and easy to mount
- Electrically isolated case
- Non-Inductive design

## Applications

- Gate Resistors in Power Supplies
- Snubbers
- Load and Dumping Resistors in CRT Monitors
- Terminal Resistance in RF Power Amplifiers
- Voltage Regulation
- Low Energy Pulse Loading
- UPS

## Dimensions

Unit: mm

Type	Weight (g) (1000pcs)
TR30	1155

## Electrical Characteristics Specifications

Item Type	Resistance Range				TCR (PPM/°C)
	±0.5%	±1%	±5%	±10%	
TR30	-	-	0.05Ω -1Ω		No Specified
	-	>1Ω -3Ω			±300
	-	>3Ω -10Ω			±100 ±200
	>10Ω -10KΩ				±50 ±100 ±200

- Operating Voltage: 420V max.
- Dielectric Strength: 1800VAC
- Insulation Resistance: 10GΩ min.
- Working Temperature Range: -65°C to +150°C
- Resistance Value <1Ω is available

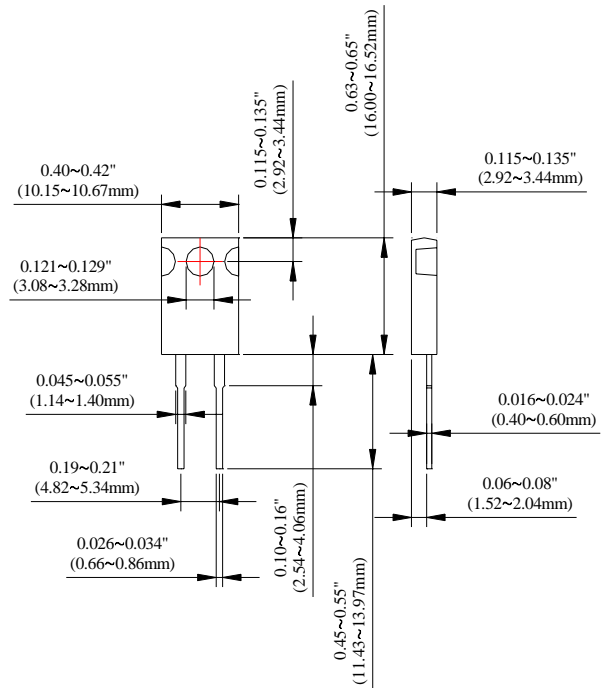

## Derating Curve

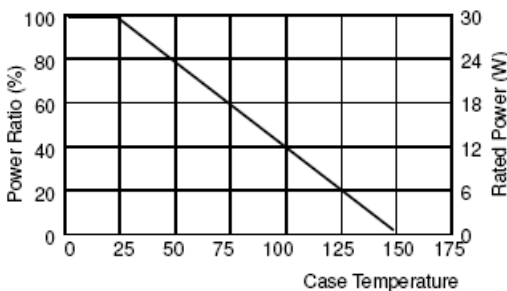

## Part Numbering

TR	30	J	B	D	1001
Product Type	Power	Resistance Tolerance	Packaging Code	TCR (PPM/°C)	Resistance
	30: 30 Watts	D: ±0.5% F: ±1% J: ±5% K: ±10%	B: Bulk	D: ±50 E: ±100 F: ±200 G: ±300 - : No Specified	R100: 0.1Ω 0100: 10Ω 4700: 470Ω 1001: 1000Ω 1002: 10000Ω

## ■ Environmental Characteristics

Item	Requirement	Test Method
Temperature Coefficient of Resistance (T.C.R.)	As Spec.	Referenced to 25°C, ΔR taken at +105°C
Short Time Overload	ΔR±0.3%	2 times rated power with applied voltage not to exceed 1.5 times maximum continuous operating voltage for 5 seconds
Load Life	ΔR±1.0%	2,000 hours at rated power
Damp Heat with Load	ΔR±0.5%	40±2°C, 90~95% R.H. Max. working voltage for 1000 hrs with 1.5 hrs "ON" and 0.5 hrs "OFF"
Solderability	90% min. coverage	245±5°C for 3 seconds
Thermal Shock	ΔR±0.3%	-65°C~150°C, 100 cycles
Terminal Strength	ΔR±0.2%	(Pull Test) 2.4N
Vibration, High Frequency	ΔR±0.2%	20g peak

- Lead Material: Tinned Copper
- Maximum Torque: 0.9 N-m
- When in Free Air at 25°C, the TR30 is Rated for 2.25W
- The Case Temperature is to be used for the Definition of the Applied Power Limit
- The Case Temperature Measurement must be made with a Thermocouple Contacting the Center of the Component mounted on the Designed Heat Sink.
- Thermal Grease should be Applied Properly

# TO-220 Power Resistor – TR35

## Construction

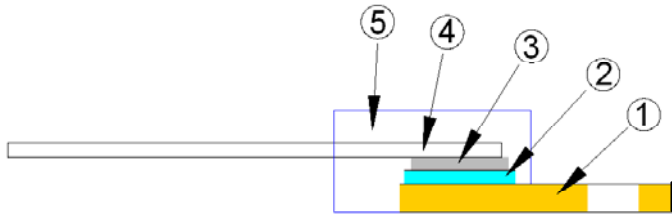

① Flange	④ Lead
② Alumina Substrate	⑤ Molding
③ Resistor Layer	

## Features

- 35 Watts at 25°C case temperature heat sink mounted
- TO-220 style power package
- Single screw mounting to heat sink
- Molded case for protection and easy to mount
- Electrically isolated case
- Non-Inductive design

## Dimensions

Unit: mm

Type	Weight (g) (1000pcs)
TR35	1902

## Applications

- Switching Power Supplies
- Snubbers Circuits
- Automated Machine Controller
- RF Power Amplifiers
- Low Energy Pulse Loading
- UPS
- Voltage Regulation

## Electrical Characteristics Specifications

Item Type	Resistance Range				TCR (PPM/°C)
	±0.5%	±1%	±5%	±10%	
TR35	-	-	0.05Ω -1Ω		No Specified
	-	>1Ω -3Ω			±300
	-	>3Ω -10Ω			±100 ±200
	>10Ω -10KΩ				±50 ±100 ±200

- Operating Voltage: 350V Max.
- Dielectric Strength: 1800VAC
- Insulation Resistance: 10GΩ min.
- Working Temperature Range: -65°C to +150°C
- Resistance Value <1Ω is available

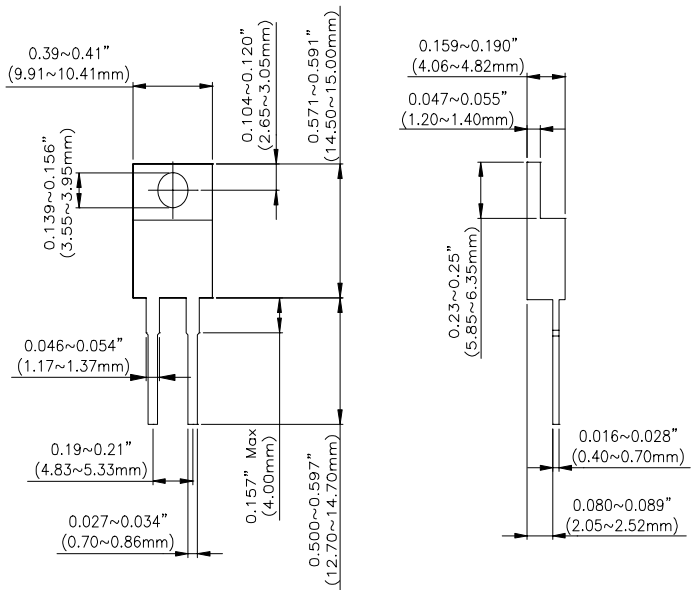

## Derating Curve

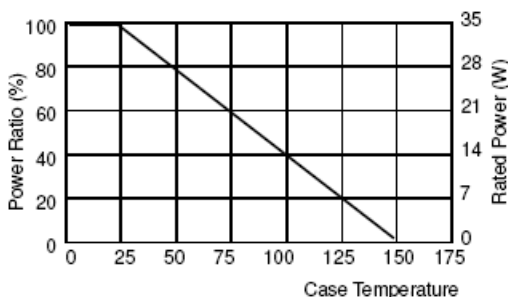

## Part Numbering

TR	35	J	B	D	1001
Product Type	Power	Resistance Tolerance	Packaging Code	TCR (PPM/°C)	Resistance
	35: 35 Watts	D: ±0.5% F: ±1% J: ±5% K: ±10%	B: Bulk	D: ±50 E: ±100 F: ±200 G: ±300 - : No Specified	R100: 0.1Ω 0100: 10Ω 4700: 470Ω 1001: 1000Ω 1002: 10000Ω

## ■ Environmental Characteristics

Item	Requirement	Test Method
Temperature Coefficient of Resistance (T.C.R.)	As Spec.	Referenced to 25°C, $\Delta R$ taken at +105°C
Short Time Overload	$\Delta R \pm 0.3\%$	2 times rated power with applied voltage not to exceed 1.5 times maximum continuous operating voltage for 5 seconds
Load Life	$\Delta R \pm 1.0\%$	2,000 hours at rated power
Damp Heat with Load	$\Delta R \pm 0.5\%$	40±2°C, 90~95% R.H. Max. working voltage for 1000 hrs with 1.5 hrs "ON" and 0.5 hrs "OFF"
Solderability	90% min. coverage	245±5°C for 3 seconds
Thermal Shock	$\Delta R \pm 0.3\%$	-65°C~150°C, 100 cycles
Terminal Strength	$\Delta R \pm 0.2\%$	(Pull Test) 2.4N
Vibration, High Frequency	$\Delta R \pm 0.2\%$	20g peak

- Lead Material: Tinned Copper
- Maximum Torque: 0.9 N-m
- Without a Heat Sink, When in Free Air at 25°C, the TR35 is Rated for 2.50W
- The Case Temperature is to be used for the Definition of the Applied Power Limit
- The Case Temperature Measurement must be made with a Thermocouple Contacting the Center of the Component mounted on the Designed Heat Sink.
- Thermal Grease should be Applied Properly.

# TO-220 Power Resistor – TR50



## Construction

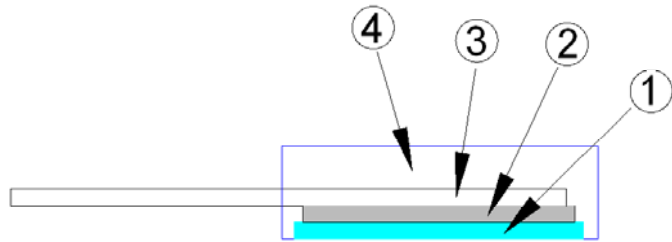

① Alumina Substrate	③ Lead
② Resistor Layer	④ Molding

## Features

- 50 Watts at 25°C case temperature heat sink mounted
- TO-220 style power package
- Molded case for protection and easy to mount
- Electrically isolated case
- Non-Inductive design

## Applications

- Switching Power Supplies
- Non-inductive Design for High Frequency
- Pulsing Applications
- UPS
- Voltage Regulation

## Dimensions

Unit: mm

Type	Weight (g) (1000pcs)
TR50	1290

## Electrical Characteristics Specifications

Item Type	Resistance Range				TCR (PPM/°C)
	±0.5%	±1%	±5%	±10%	
TR50	-	-	0.1Ω -1Ω		No Specified
	-	>1Ω -3Ω			±300
	-	>3Ω -10Ω			±100 ±200
	>10Ω -10KΩ				±50 ±100 ±200

- Operating Voltage: 350V Max.
- Dielectric Strength: 1800VAC
- Insulation Resistance: 10GΩ min.
- Working Temperature Range: -65°C to +150°C
- Resistance Value <1Ω is available

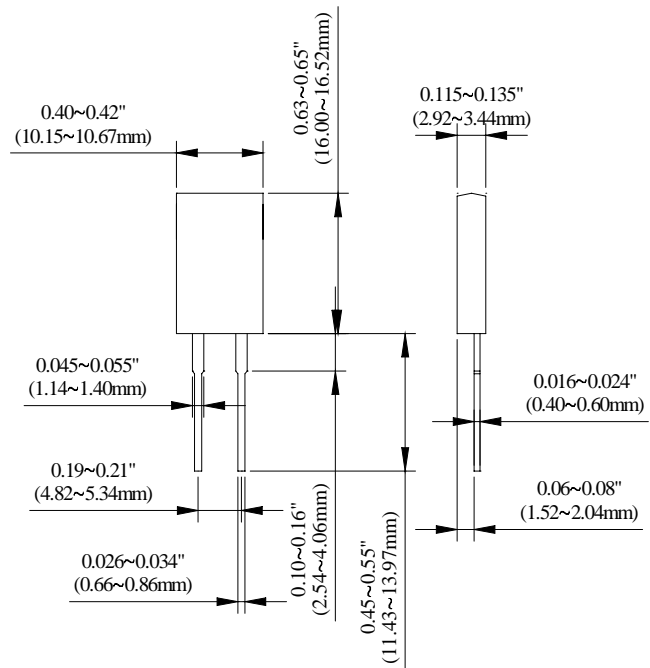

## Derating Curve

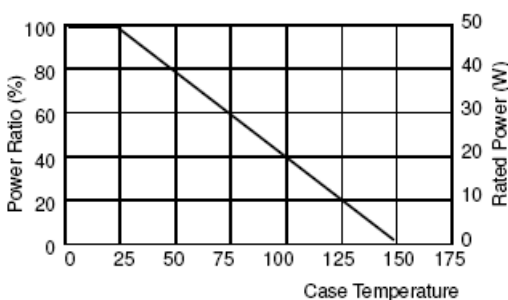

## Part Numbering

TR	50	J	B	D	1001
Product Type	Power 50: 50 Watts	Resistance Tolerance D: ±0.5% F: ±1% J: ±5% K: ±10%	Packaging Code B: Bulk	TCR (PPM/°C) D: ±50 E: ±100 F: ±200 G: ±300 - : No Specified	Resistance R100: 0.1Ω 0100: 10Ω 4700: 470Ω 1001: 1000Ω 1002: 10000Ω

## ■ Environmental Characteristics

Item	Requirement	Test Method
Temperature Coefficient of Resistance (T.C.R.)	As Spec.	Referenced to 25°C, ΔR taken at +105°C
Short Time Overload	ΔR±0.3%	2 times rated power with applied voltage not to exceed 1.5 times maximum continuous operating voltage for 5 seconds
Load Life	ΔR±1.0%	2,000 hours at rated power
Damp Heat with Load	ΔR±0.5%	40±2°C, 90~95% R.H. Max. working voltage for 1000 hrs with 1.5 hrs "ON" and 0.5 hrs "OFF"
Solderability	90% min. coverage	245±5°C for 3 seconds
Thermal Shock	ΔR±0.3%	-65°C~150°C, 100 cycles
Terminal Strength	ΔR±0.2%	(Pull Test) 2.4N
Vibration, High Frequency	ΔR±0.2%	20g peak

- Lead Material: Tinned Copper
- Without a Heat Sink, When in Free Air at 25°C, the TR50 is Rated for 3W.
- The Case Temperature is to be used for the Definition of the Applied Power Limit.
- The Case Temperature Measurement must be made with a Thermocouple Contacting the Center of the Component mounted on the Designed Heat Sink.
- Thermal Grease should be Applied Properly.



# TO-220 Power Resistor – TR50-H



## Construction

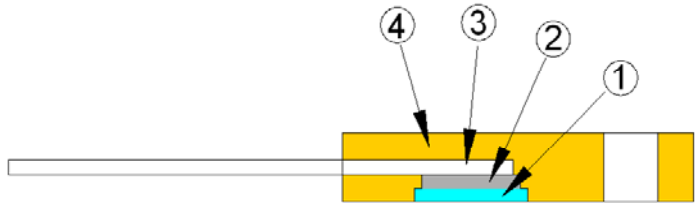

① Alumina Substrate	③ Lead
② Resistor Layer	④ Molding

## Features

- 50 watts at  $\leq 25^{\circ}\text{C}$  case temperature heat sink mounted
- TO-220 style power package
- Fixed with a M3 screw on system heat sink.
- Improve the heat dissipation by ceramic exposure design with external fix jig to mount the chip on heat sink

## Applications

- Power Supplies
- Non-inductive Design for High Frequency
- Pulsing Applications

## Dimensions

Unit: mm

Type	Weight (g) (1000pcs)
TR50-H	2770

Unit: mm

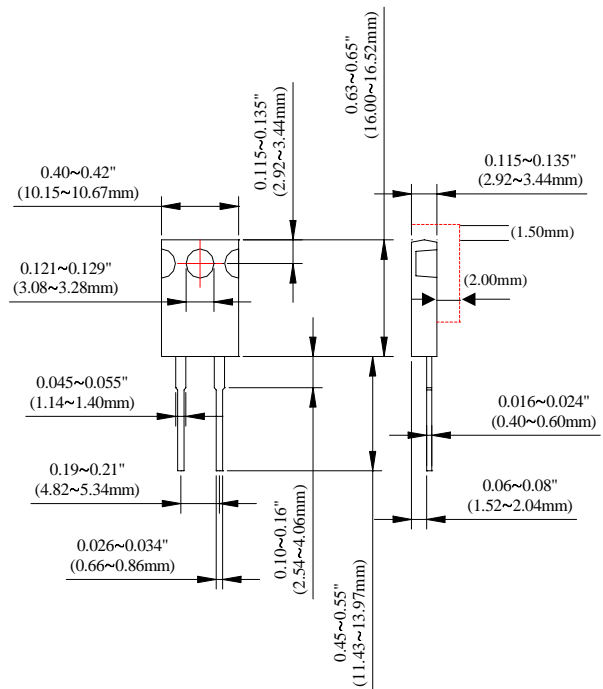

## Electrical Characteristics Specifications

Item Type	Resistance Range				TCR (PPM/°C)
	±0.5%	±1%	±5%	±10%	
TR50-H	-	-	0.1Ω -1Ω		No Specified
	-	-	>1Ω -3Ω		±300
	-	-	>3Ω -10Ω		±100 ±200
	-	-	>10Ω -10KΩ		±50 ±100 ±200

- Operating Voltage: 420V Max.
- Dielectric Strength: 1800VAC
- Insulation Resistance: 10GΩ min.

## Derating Curve

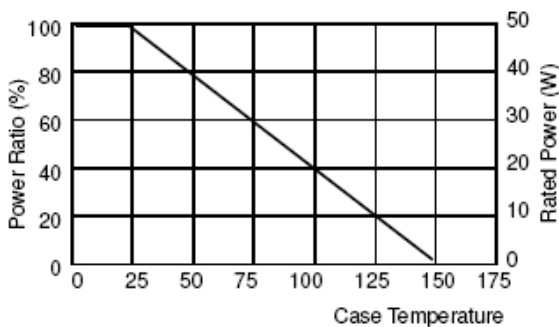

## Part Numbering

TR	50	J	B	D	1001	-H
Product Type	Power	Resistance Tolerance	Packaging Code	TCR (PPM/°C)	Resistance	Code
	50: 50 Watts	D: ±0.5% F: ±1% J: ±5% K: ±10%	B: Bulk	D: ±50 E: ±100 F: ±200 G: ±300 -: No Specified	R100: 0.1Ω 0100: 10Ω 4700: 470Ω 1001: 1000Ω 1002: 10000Ω	H: Hole

## Environmental Characteristics

Item	Requirement	Test Method
Temperature Coefficient of Resistance (T.C.R.)	As Spec.	Referenced to 25°C, ΔR taken at +105°C
Short Time Overload	ΔR±0.3%	2 times rated power with applied voltage not to exceed 1.5 times maximum continuous operating voltage for 5 seconds
Load Life	ΔR±1.0%	2,000 hours at rated power
Damp Heat with Load	ΔR±0.5%	40±2°C, 90~95% R.H. Max. working voltage for 1000 hrs with 1.5 hrs "ON" and 0.5 hrs "OFF"
Solderability	90% min. coverage	245±5°C for 3 seconds
Thermal Shock	ΔR±0.3%	-65°C ~150°C, 100 cycles
Terminal Strength	ΔR±0.2%	(Pull Test) 2.4N
Vibration, High Frequency	ΔR±0.2%	20g peak

- Lead Material: Tinned Copper
- Maximum Torque: 0.9 N-m
- Without a Heat Sink, When in Free Air at 25°C, the TR50-H is Rated for 2.25W.
- The Case Temperature is to be used for the Definition of the Applied Power Limit.
- The Case Temperature Measurement must be made with a Thermocouple Contacting the Center of the Component mounted on the Designed Heat Sink.
- Thermal Grease should be Applied Properly.

# TO-247 Power Resistor – TR100



## Construction

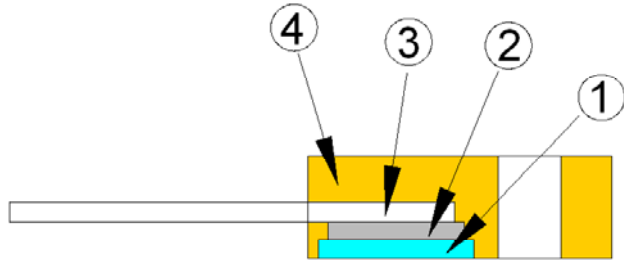

① Alumina Substrate	③ Lead
② Resistor Layer	④ Molding

## Features

- 100 Watts at 25°C case temperature heat sink mounted
- TO-247 style power package
- Single M3 screw mounting to heat sink
- Molded case for protection and easy to mount
- Electrically isolated case
- Non-Inductive design

## Applications

- Gate Resistors in Power Supplies
- Snubbers
- Load and Dumping Resistors in CRT Monitors
- Terminal Resistance in RF Power Amplifier
- Voltage Regulation
- Low Energy Pulse Loading
- UPS

## Electrical Characteristics Specifications

Item	Resistance Range			TCR (PPM/°C)
	±1%	±5%	±10%	
TR100	-	0.05Ω -1Ω		No Specified
		>1Ω -3Ω		±300
		>3Ω -10Ω		±100 ±200
		>10Ω -10KΩ		±50 ±100 ±200

- Operating Voltage: 700V Max.
- Dielectric Strength: 1800V AC
- Insulation Resistance: 10GΩ min.
- Working Temperature Range: -65°C to +175°C

## Derating Curve

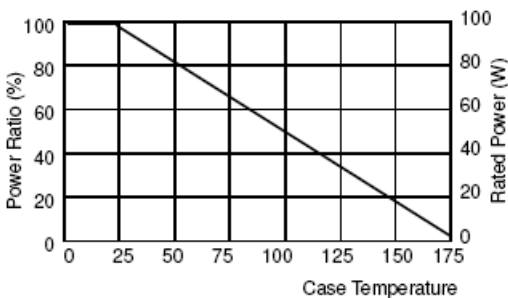

## Part Numbering

<b>TR</b>	<b>100</b>	<b>J</b>	<b>B</b>	<b>D</b>	<b>1001</b>
Product Type	Power	Resistance Tolerance	Packaging Code	TCR (PPM/°C)	Resistance
	100: 100 Watts	F: ±1% J: ±5% K: ±10%	B: Bulk	D: ±50 E: ±100 F: ±200 G: ±300 - : No Specified	R100: 0.1Ω 0100: 10Ω 4700: 470Ω 1001: 1000Ω 1002: 10000Ω

## ■ Environmental Characteristics

Item	Requirement	Test Method
Temperature Coefficient of Resistance (T.C.R.)	As Spec.	Referenced to 25°C, $\Delta R$ taken at +105°C
Load Life	$\Delta R \pm 1.0\%$	Rated power, 2,000 hours
Solderability	90% min. coverage	245±5°C for 3 seconds
Momentary Overload	$\Delta R \pm 0.5\%$	1.5 times rated power and V (dc) $\leq 1.5V$ Max. for 5 seconds
Dielectric strength	$\Delta R \pm 0.15\%$	1800v AC, 60 seconds
Moisture resistance	$\Delta R \pm 0.5\%$	-10°C~+65°C, RH>90%, cycle 240 hours
Thermal Shock	$\Delta R \pm 0.5\%$	-65°C~150°C, 100 cycles
Terminal Strength	$\Delta R \pm 0.2\%$	(Pull Test) 2.4N
Vibration, High Frequency	$\Delta R \pm 0.4\%$	20g peak

- Lead Material: Tinned Copper
- Maximum Torque: 0.9 Nm
- When in Free Air at 25°C, the TR100 is Rated for 3.5W
- The Case Temperature is to be used for the Definition of the Applied Power Limit
- The Case Temperature Measurement must be made with a Thermocouple Contacting the Center of the Component mounted on the Designed Heat Sink
- Thermal Grease should be Applied Properly.