

1000 series

Toggle switches - metal lever - economy range

Distinctive features and specifications

UG1006-A

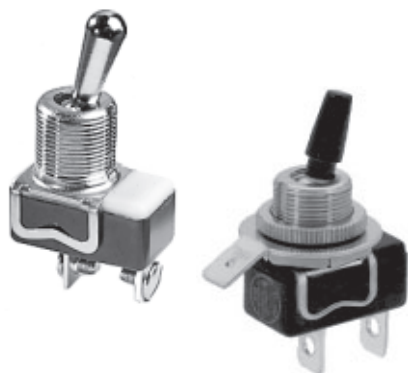

- Butt action contacts
- Optional insulated levers (X213 and X490)

ELECTRICAL SPECIFICATIONS

- Max. current/voltage rating with resistive load :
 - silver contacts (A) : 3A 250VAC - 6A 125VAC - 6A 30VDC
 - silver plated copper contacts (C) : 2A 250VAC
- Initial contact resistance : 10 mΩ max.
- Insulation resistance : 1.000 MΩ min. at 500VDC
- Dielectric strength :
 - 2.000 Vrms 50 Hz min. between terminals
 - 2.500 Vrms 50 Hz min. between terminals and frame
- Electrical life : 10.000 cycles at full load

MATERIALS

- Case :
 - function 1 : phenolic resin
 - funct. 6 & 9 : polyamide
- Actuator :
 - brass, nickel plated (1010 and 1020 models)
 - polyamide (1030 models)
- Bushing : brass, nickel plated
- Contacts :
 - A : silver
 - C : copper, silver plated

GENERAL SPECIFICATIONS

- Torque : 1,50 Nm (1.10 Ft.lb) max. applied to nut
- Panel thickness : 5 mm (.196) max.
- Operating temperature : -20°C to +55°C

ABOUT THIS SERIES

Dimensions : first dimensions are in mm while inches are shown as bracketted numbers.



Sealing boots are available to protect the switches against dust and water. They are presented in section H.



Mounting accessories : standard hardware supplied :
 - silver contact models : 1 hex nut U166 + 1 knurled nut U411
 - copper contact models : 1 hex nut U42 + 1 knurled nut U411



Packaging unit : 25 or 40 pieces depending on model.

1000 series

Toggle switches - metal lever - economy range

Solder lug and quick-connect terminals - screw terminals

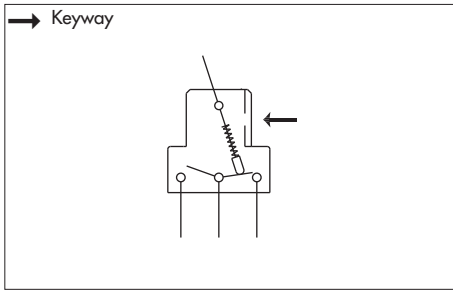
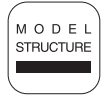

- 2 and 3 positions
- Single pole configurations

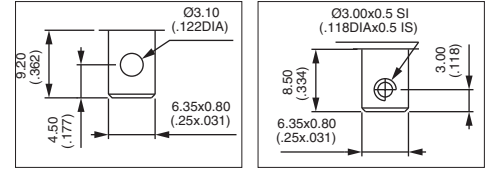

MODEL STRUCTURE

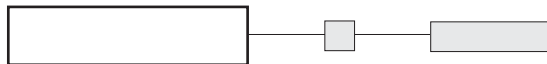

Solder lug and quick-connect terminals



1011
1016
1019

I	II	III
ON	-	OFF
ON	-	ON
ON	OFF	ON

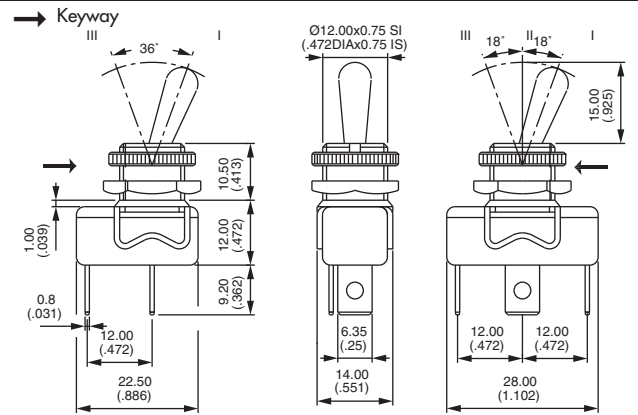

Screw terminals



1021

I	II	III
ON	-	OFF

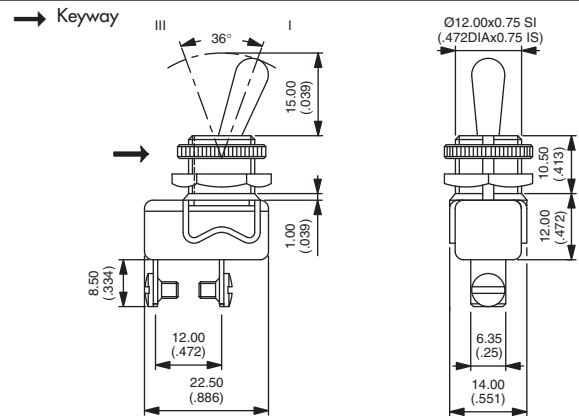

PANEL CUT-OUT

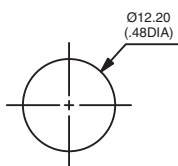



1000 series

Toggle switches - metal lever - economy range

Solder lug and quick-connect terminals - screw terminals

CONTACT MATERIALS

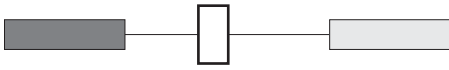

- A Silver
- C Copper, silver plated

SPECIAL OPTIONS WITH INSULATED LEVER

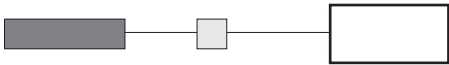

X213 Silver plated copper contacts (C)



1031CX213

I	II
OFF	ON

→ Keyway

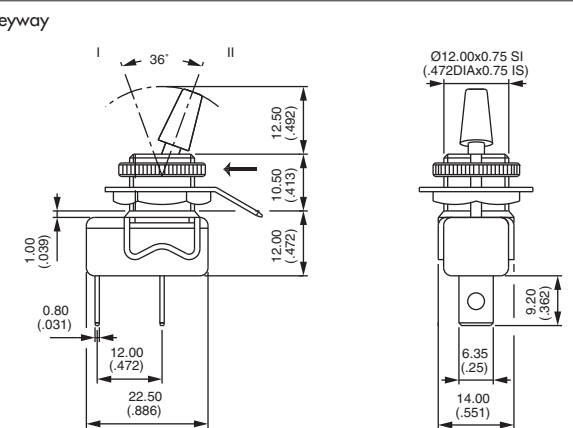

Ground connector **U187** compulsory if the panel is not metallic or not connected to ground. Order separately, see section I.

X490 Available with silver contacts (A) or silver plated copper contacts (C)



1036 X490
1039 X490

I	II	III
ON	- OFF	ON

→ Keyway

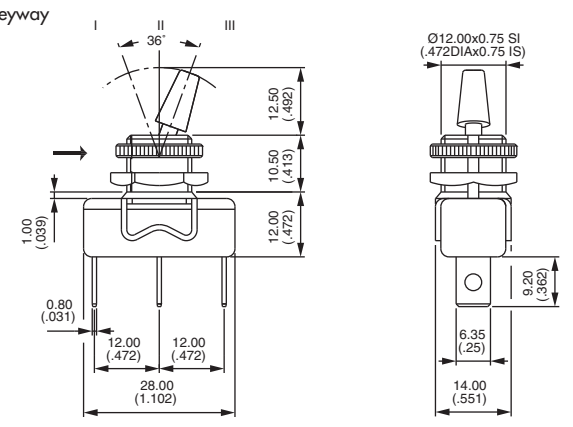

A