

■ Package Dimensions :

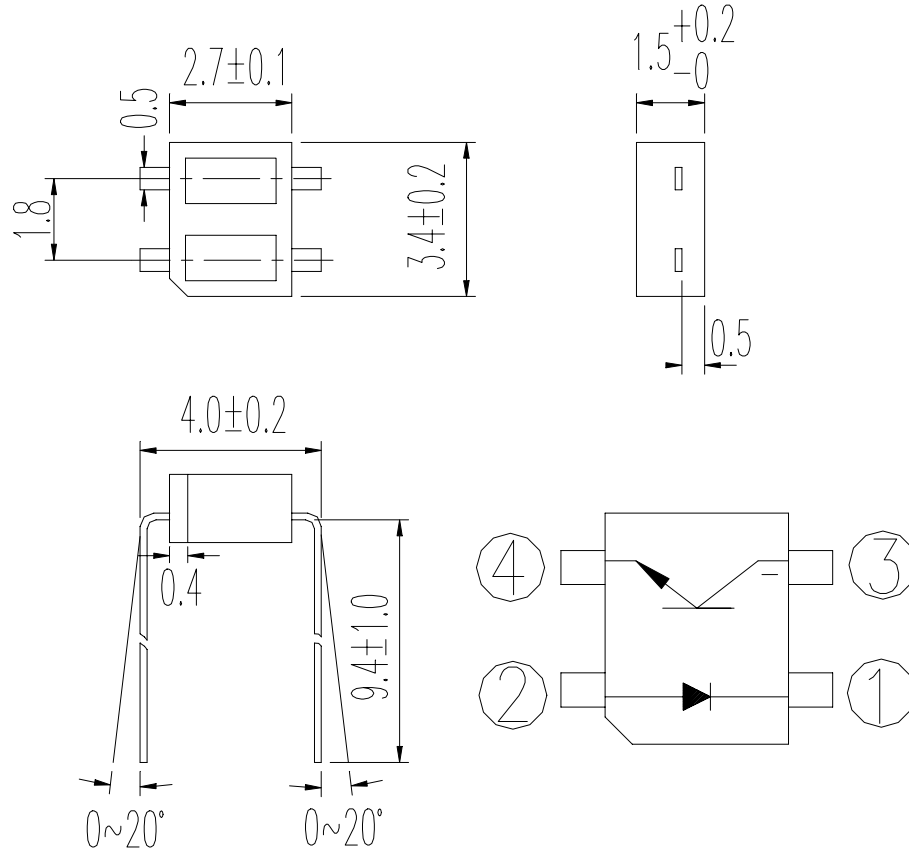

- ① :CATHODE ③ :COLLECTOR
- ② :ANODE ④ :EMITTER

General tolerance:±0.15mm
UNIT:mm

The specification may be changed without notice. Supplier will reserve authority on material change for above specification.

Designer	Checker	Approved

Office: NO 25, Lane 76, Chung Yang Rd, ,Sec.3
Tucheng, Taipei 236, Taiwan, R.O.C.
TEL: 886-2-2267-2000, 2267-9936 (22Lines)
FAX: 886-2-2267-6189

■Features

- Fast response time
- High sensitivity
- Non contact switching
- Thin
- Compact

■Description

ITR8307/F43 is a light reflection switch which includes a GaAs IRLED transmitter and a NPN photo-transistor with a high photosensitive receiver for short distance, operating in the infrared range. Both components are mounted side-by-side in a plastic package.

■Applications

- Camera
- VCR
- Floppy disk driver
- Cassette type recorder
- Various microcomputer control equipment

Absolute Maximum Ratings (Ta=25°C)

Parameter		Symbol	Ratings	Unit
Input	Power Dissipation	Pd	75	mW
	Reverse Voltage	Vr	5	V
	Forward Current	If	50	mA
	Peak Forward Current (*1)	Ifp	1	A
Output	Collector Power Dissipation	Pc	100	mW
	Collector Current	Ic	50	mA
	C-E Breakdown Voltage	B Vceo	30	V
	E-C Breakdown Voltage	B Veco	5	V
Operating Temperature		Topr	-20~+70	°C
Storage Temperature		Tstg	-30~+80	°C
Soldering Temperature (*2)		Tsol	260	°C

(*1) $t_w=100 \mu\text{sec.}$, $T=10 \text{ msec.}$ (*2) $t=5 \text{ Sec}$

Electrical Characteristics (Ta=25°C)

Parameter		Symbol	Min.	Typ.	Max.	Unit	Conditions
Input	Forward Voltage	V_F	---	1.2	1.6	V	$I_F=20\text{mA}$
	Reverse Current	I_R	---	---	10	μA	$V_R=5\text{V}$
	Peak Wavelength	λ_P		940		nm	
Output	Dark Current	I_{CEO}	---	---	100	nA	$V_{CE}=10\text{V}$
	C-E Saturation Voltage	$V_{CE}(\text{sat})$	---	---	0.4	V	$I_C=2\text{mA}$ $E_E=1\text{mW}/\text{cm}^2$
	Transfer Characteristic	Collector Current	$I_{C(ON)}$	0.1	---	---	$V_{CE}=5\text{V}$ $I_F=20\text{mA}$
Transfer Characteristic	Leakage Current	I_{LEAK}	---	---	1	μA	
	Rise time	T_R	---	20	---	μsec	$V_{CE}=2\text{V}$ $I_C=100 \mu\text{A}$ $R_L=1\text{K}\Omega$
Transfer Characteristic	Fall time	T_F	---	20	---	μsec	

Typical Characteristics For IR

Fig. 1 Forward Current vs. Ambient Temperature

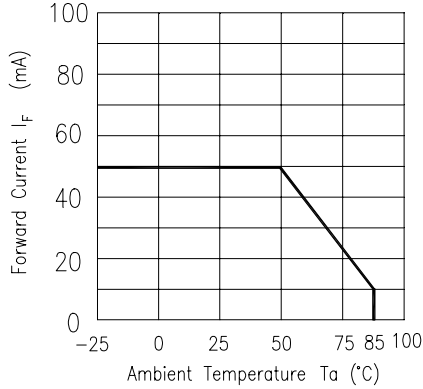

Fig. 2 Spectral Distribution

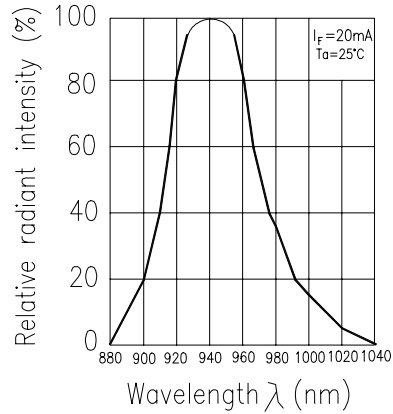

Fig. 3 Peak Emission Wavelength vs. Ambient Temperature

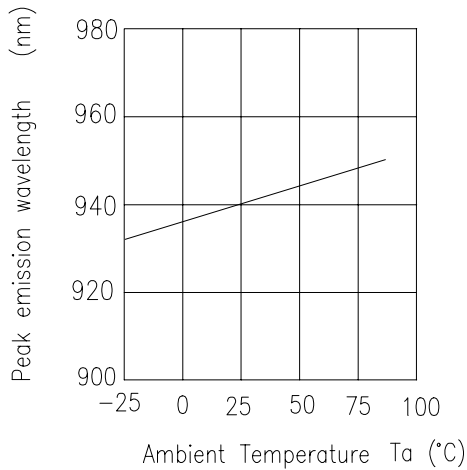

Fig. 4 Forward Current vs. Forward Voltage

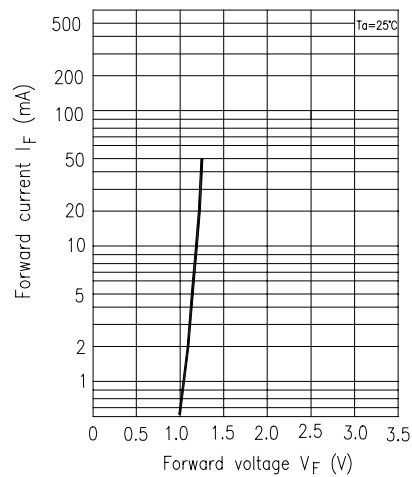

Fig. 5 Forward Voltage vs. Temperature

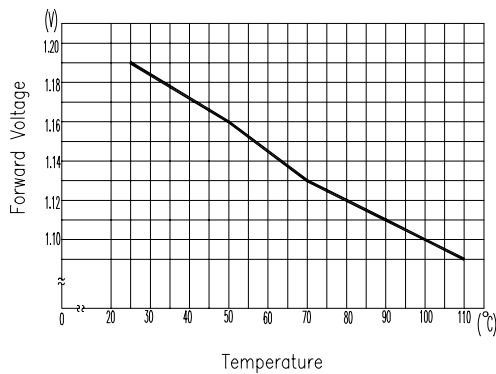
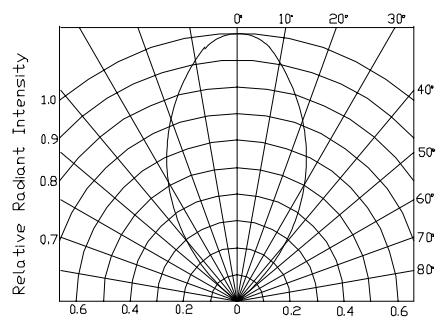

Fig. 6 Relative Radiant Intensity vs. Angular Displacement



Typical Characteristics For PT

Fig.1 Collector Power Dissipation vs. Ambient Temperature

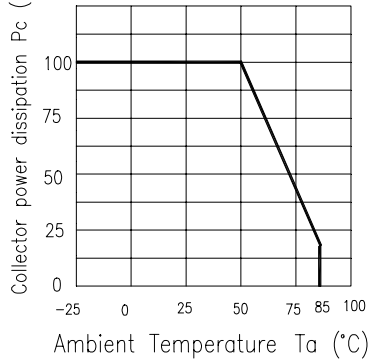

Fig.2 Collector Dark Current vs. Ambient Temperature

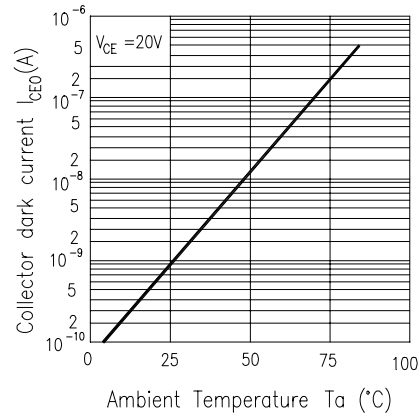

Fig. 3 Relative Collector Current vs. Ambient Temperature

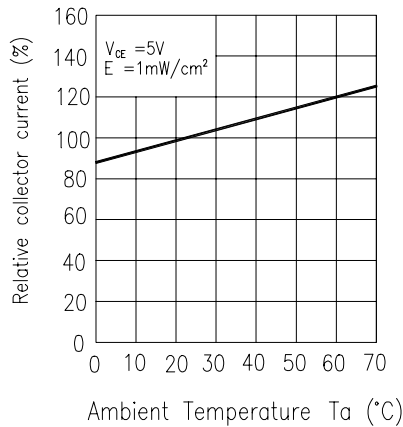

Fig.4 Collector Current vs. Irradiance

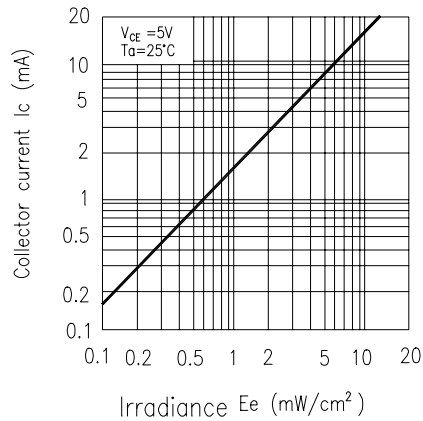

Fig.5 Spectral Sensitivity

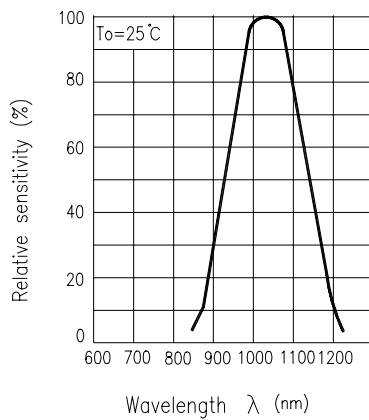
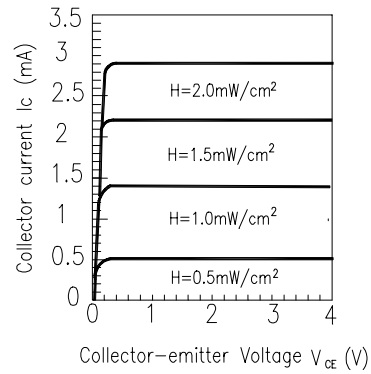

Fig.6 Collector Current vs. Collector-emitter Voltage



Typical Characteristics For ITR

Fig.1 Relative Collector Current vs. Distance between Sensor and Al Evaporation Galss

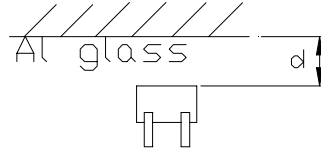
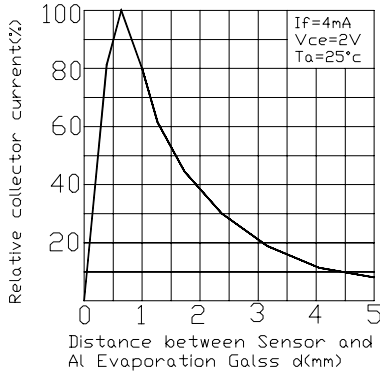

Fig.2 Relative Collector Current vs. Card Moving Distance (1)

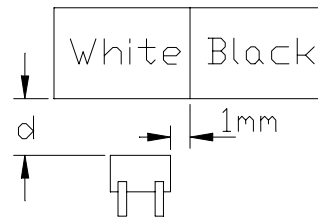
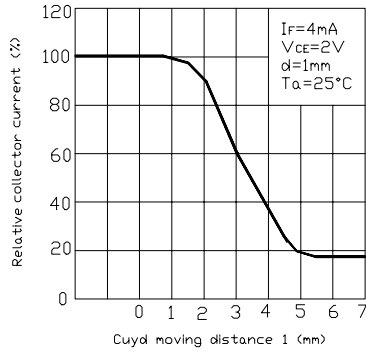

Fig.3 Response Time vs. Load Resistance

