

MSA-0886

Cascadable Silicon Bipolar MMIC Amplifier



Data Sheet

Description

The MSA-0886 is a high performance silicon bipolar Monolithic Microwave Integrated Circuit (MMIC) housed in a low cost, surface mount plastic package. This MMIC is designed for use as a general purpose $50\ \Omega$ gain block above 0.5 GHz and can be used as a high gain transistor below this frequency. Typical applications include narrow and moderate band IF and RF amplifiers in commercial and industrial applications.

The MSA-series is fabricated using Avago's 10 GHz f_T , 25 GHz f_{MAX} , silicon bipolar MMIC process which uses nitride self-alignment, ion implantation, and gold metallization to achieve excellent performance, uniformity and reliability. The use of an external bias resistor for temperature and current stability also allows bias flexibility.

Features

- Lead-free Option Available
- Usable Gain to 5.5 GHz
- High Gain:
32.5 dB Typical at 0.1 GHz
22.5 dB Typical at 1.0 GHz
- Low Noise Figure:
3.3 dB Typical at 1.0 GHz
- Surface Mount Plastic Package
- Tape-and-Reel Packaging Option Available
- Lead-free Option Available

86 Plastic Package

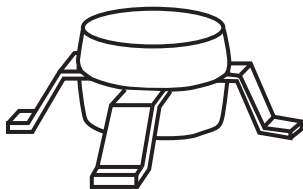

Typical Biasing Configuration

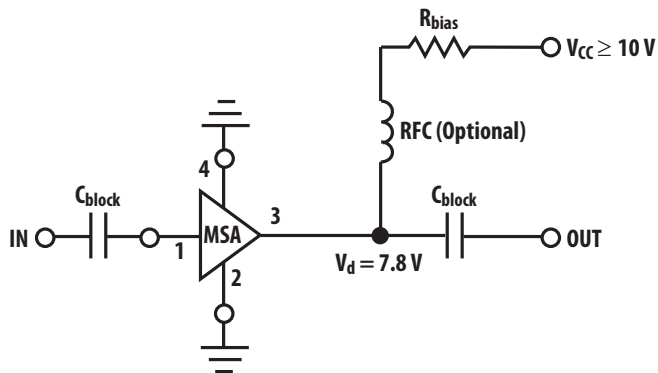

MSA-0886 Absolute Maximum Ratings

Parameter	Absolute Maximum ^[1]
Drain Current	65 mA
Power Dissipation ^[2, 3]	500 mW
RF Input Power	+13 dBm
Junction Temperature	150° C
Storage Temperature	-65° C to 150° C

Thermal Resistance ⁽²⁾
 $\theta_{jc} = 140^{\circ}\text{C/W}$

Notes:

1. Permanent damage may occur if any of these limits are exceeded.
2. $T_{\text{CASE}} = 25^{\circ}\text{C}$.
3. Derate at 7.1 mW/°C for $T_{\text{C}} > 80^{\circ}\text{C}$.

Electrical Specifications^[1], $T_{\text{A}} = 25^{\circ}\text{C}$

Symbol	Parameters and Test Conditions: $I_{\text{d}} = 36\text{ mA}$, $Z_0 = 50\ \Omega$	Units	Min.	Typ.	Max.
GP	Power Gain ($ S_{21} ^2$) f = 0.1 GHz f = 1.0 GHz	dB	20.5	32.5 22.5	
VSWR	Input VSWR f = 0.1 to 3.0 GHz			2.1:1	
	Output VSWR f = 0.1 to 3.0 GHz			1.9:1	
NF	50 Ω Noise Figure f = 1.0 GHz	dB		3.3	
$P_{1\text{dB}}$	Output Power at 1 dB Gain Compression f = 1.0 GHz	dBm		12.5	
IP_3	Third Order Intercept Point f = 1.0 GHz	dBm		27.0	
t_{D}	Group Delay f = 1.0 GHz	psec		140	
V_{d}	Device Voltage	V	6.2	7.8	9.4
dV/dT	Device Voltage Temperature Coefficient	mV/°C		-17.0	

Note:

1. The recommended operating current range for this device is 20 to 40 mA. Typical performance as a function of current is on the following page.

Ordering Information

Part Numbers	No. of Devices	Comments
MSA-0886-BLK	100	Bulk
MSA-0886-BLKG	100	Bulk
MSA-0886-TR1	1000	7" Reel
MSA-0886-TR1G	1000	7" Reel
MSA-0886-TR2	4000	13" Reel
MSA-0886-TR2G	4000	13" Reel

Note: Order part number with a "G" suffix if lead-free option is desired.

MSA-0886 Typical Scattering Parameters^[1] ($Z_0 = 50 \Omega$, $T_A = 25^\circ C$, $I_d = 36 mA$)

Freq. GHz	S ₁₁		S ₂₁			S ₁₂			S ₂₂		k
	Mag	Ang	dB	Mag	Ang	dB	Mag	Ang	Mag	Ang	
0.1	0.63	-22	32.5	42.12	160	-36.7	0.015	54	0.62	-24	0.68
0.2	0.56	-41	31.3	36.68	143	-33.9	0.020	50	0.55	-46	0.64
0.4	0.43	-69	28.6	26.94	119	-29.1	0.035	52	0.43	-79	0.69
0.6	0.35	-88	26.4	20.89	104	-27.0	0.045	49	0.34	-103	0.77
0.8	0.30	-104	24.2	16.21	93	-25.3	0.054	50	0.29	-124	0.83
1.0	0.27	-116	22.4	13.20	83	-24.2	0.062	49	0.26	-139	0.87
1.5	0.27	-144	19.2	9.15	65	-21.6	0.083	46	0.23	-172	0.93
2.0	0.31	-166	16.7	6.84	49	-19.5	0.105	41	0.22	163	0.96
2.5	0.35	178	14.8	5.50	38	-17.9	0.128	36	0.21	149	0.96
3.0	0.40	162	12.9	4.41	25	-17.4	0.135	30	0.20	132	1.01
3.5	0.45	149	11.4	3.72	13	-16.8	0.145	25	0.19	124	1.02
4.0	0.51	137	9.9	3.14	1	-16.1	0.157	19	0.18	121	1.01
5.0	0.61	116	7.3	2.31	-22	-15.7	0.164	10	0.17	130	1.00
6.0	0.68	100	4.6	1.69	-42	-15.2	0.173	4	0.23	143	0.95

Typical Performance, $T_A = 25^\circ\text{C}$

(unless otherwise noted)

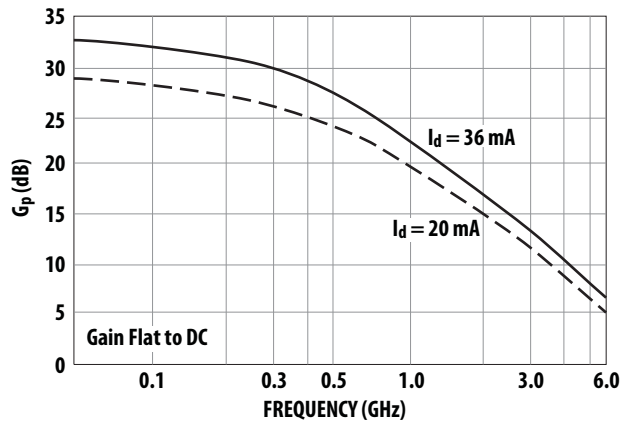

Figure 1. Typical Power Gain vs Frequency, $I_d = 36\text{ mA}$.

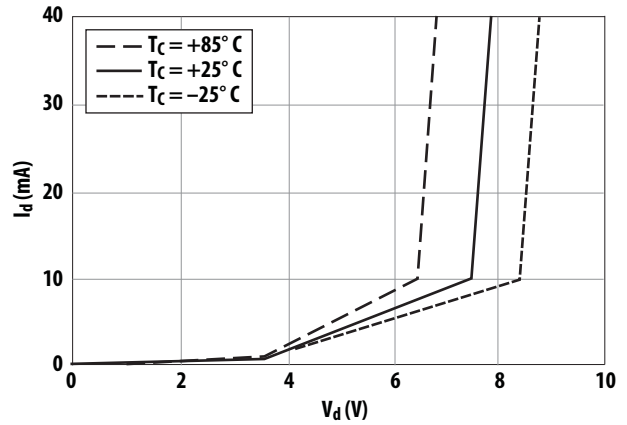

Figure 2. Device Current vs. Voltage.

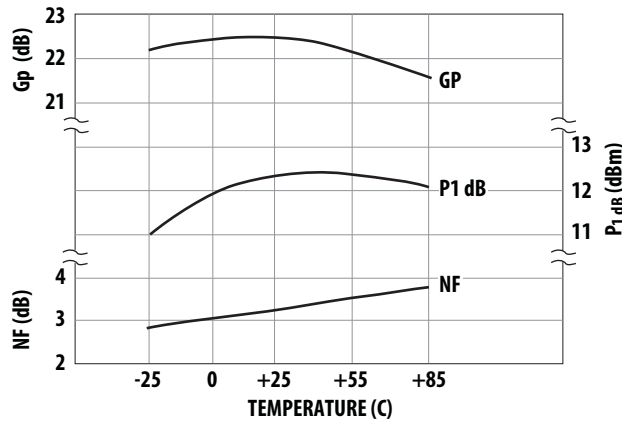

Figure 3. Output Power at 1 dB Gain Compression, NF and Power Gain vs. Case Temperature, $f = 1.0\text{ GHz}$, $I_d = 36\text{ mA}$.

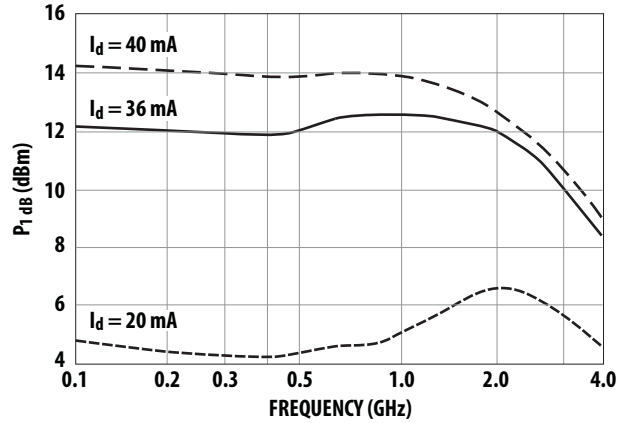

Figure 4. Output Power at 1 dB Gain Compression vs. Frequency.

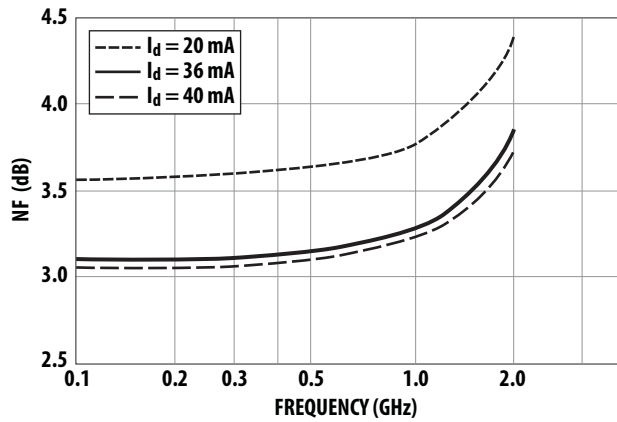
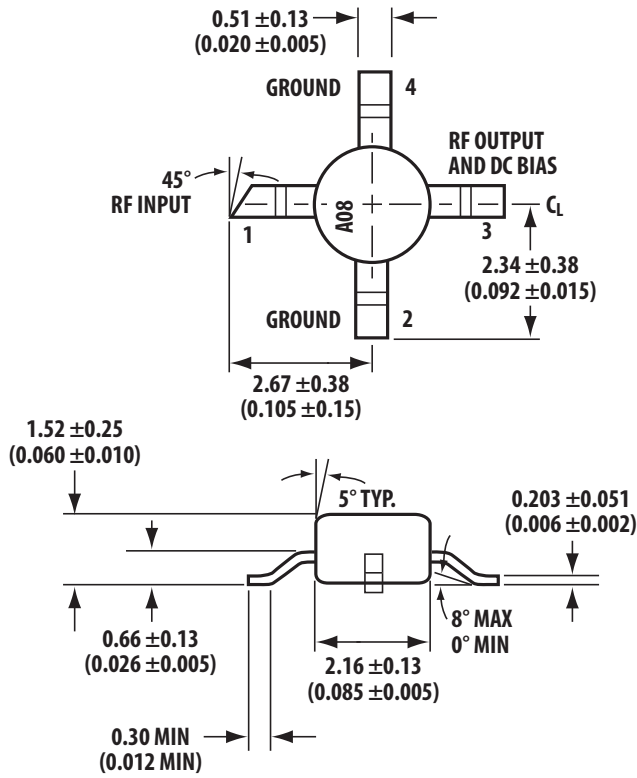

Figure 5. Noise Figure vs. Frequency.

86 Plastic Package Dimensions



Dimensions are in millimeters (inches)

For product information and a complete list of distributors, please go to our web site: www.avagotech.com

Avago, Avago Technologies, and the A logo are trademarks of Avago Technologies in the United States and other countries. Data subject to change. Copyright © 2005-2012 Avago Technologies. All rights reserved. Obsoletes 5989-2744EN AV02-3580EN - June 11, 2012

Avago
TECHNOLOGIES