



# Technical Data Sheet

## 3mm Phototransistor T-1

---

### PT204-6B

#### Features

- Fast response time
- High photo sensitivity
- Pb free
- The product itself will remain within RoHS compliant version.



#### Descriptions

- PT204-6B is a high speed and high sensitive NPN silicon phototransistor molded in a standard  $\phi 3$  mm package. Due to its black epoxy the device is sensitive

#### Applications

- Infrared applied system
- Camera
- Printer
- Cockroach catcher

#### Device Selection Guide

LED Part No.	Chip	Lens Color
	Material	
PT	Silicon	Black

**Package Dimensions**

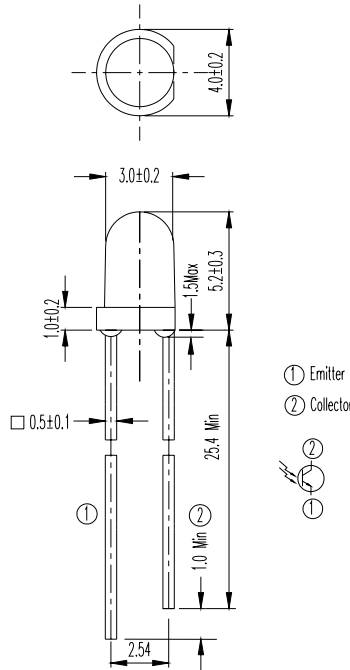

- Notes:** 1.All dimensions are in millimeters  
 2.Tolerances unless dimensions  $\pm 0.25\text{mm}$

**Absolute Maximum Ratings (Ta=25°C)**

Parameter	Symbol	Rating	Units
Collector-Emitter Voltage	V <sub>CEO</sub>	30	V
Emitter-Collector-Voltage	V <sub>ECO</sub>	5	V
Collector Current	I <sub>C</sub>	20	mA
Operating Temperature	T <sub>opr</sub>	-25 ~ +85°C	°C
Storage Temperature	T <sub>stg</sub>	-40 ~ +85°C	°C
Lead Soldering Temperature	T <sub>sol</sub>	260	°C
Power Dissipation at (or below) 25°C Free Air Temperature	P <sub>c</sub>	75	mW

**Notes:** \*1:Soldering time  $\leq 5$  seconds.

**Electro-Optical Characteristics (Ta=25°C)**

Parameter	Symbol	Condition	Min.	Typ.	Max.	Units
Rang Of Spectral Bandwidth	$\lambda_{0.5}$	---	840	---	1100	nm
Wavelength of Peak Sensitivity	$\lambda_P$	---	---	940	---	nm
Collector – Emitter Breakdown Voltage	$BV_{CEO}$	$I_C=100\mu A$ $E_e=0mW/cm^2$	30	---	---	V
Emitter-Collector Breakdown Voltage	$BV_{ECO}$	$I_E=100\mu A$ $E_e=0mW/cm^2$	5	---	---	V
Collector-Emitter Saturation Voltage	$V_{CE(sat)}$	$I_C=2mA$ $E_e=1mW/cm^2$	---	---	0.4	V
Rise Time	$t_r$	$V_{CE}=5V$ $I_C=1mA$ $RL=1000\Omega$	---	15	---	$\mu S$
Fall Time	$t_f$		---	15	---	
Collector Dark Current	$I_{CEO}$	$E_e=0mW/cm^2$ $V_{CE}=20V$	---	---	100	nA
On State Collector Current	$I_{C(on)}$	$E_e=1mW/cm^2$ $V_{CE}=5V$	0.7	2.0	---	mA

**Rankings**

Parameter	Symbol	Min	Max	Unit	Test Condition
G	$I_{C(ON)}$	0.70	1.90	mA	$V_{CE}=5V$ $E_e=1mW/c\ m^2$
H		1.14	2.60		
J		1.77	3.61		
K		2.67	5.07		

**Typical Electro-Optical Characteristics Curves**

Fig.1 Collector Power Dissipation vs. Ambient Temperature

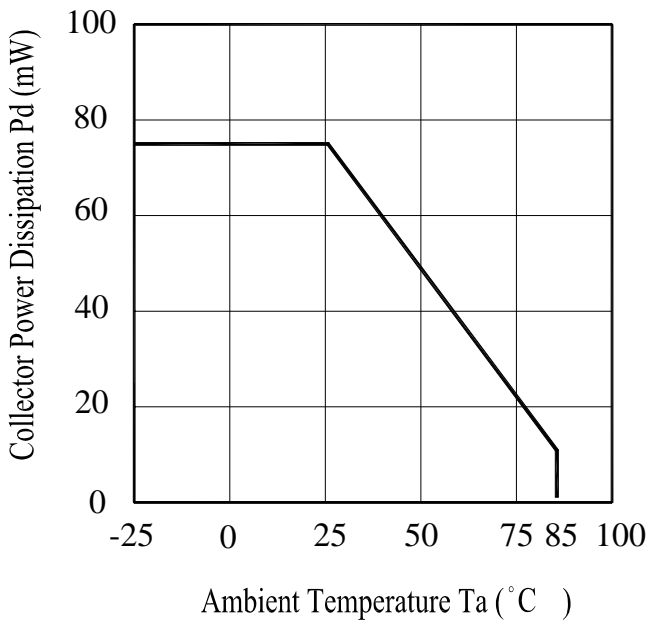

Fig.2 Spectral Sensitivity

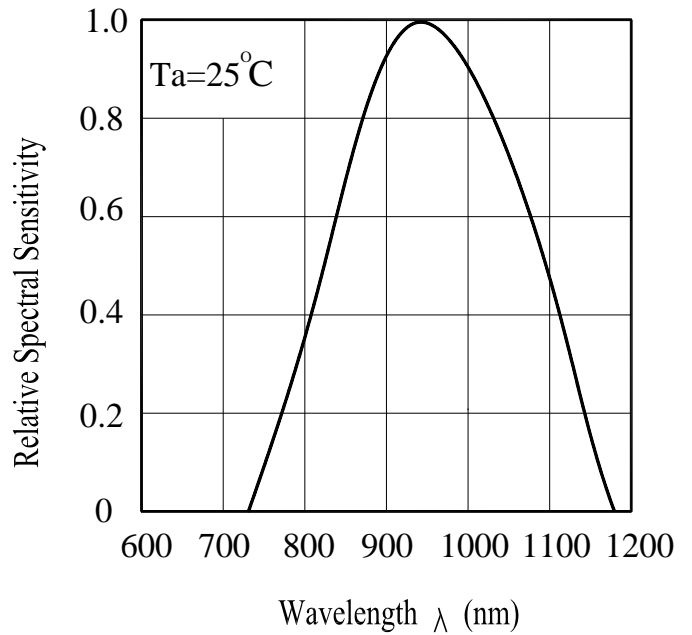

Fig.3 Relative Collector Current vs. Ambient Temperature

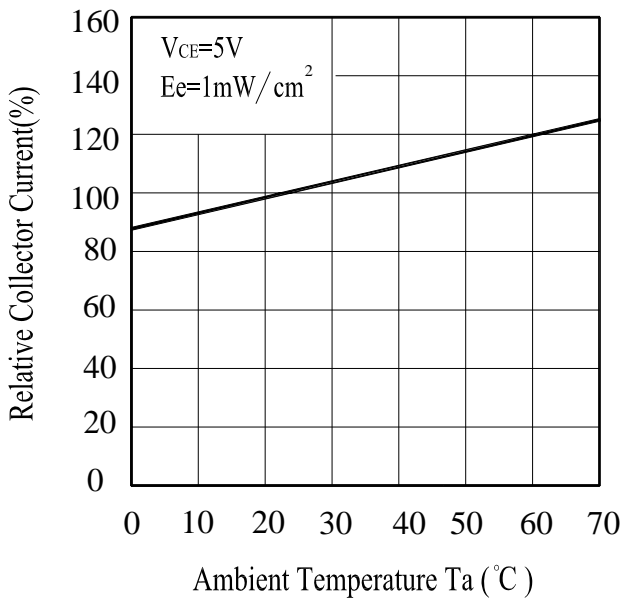
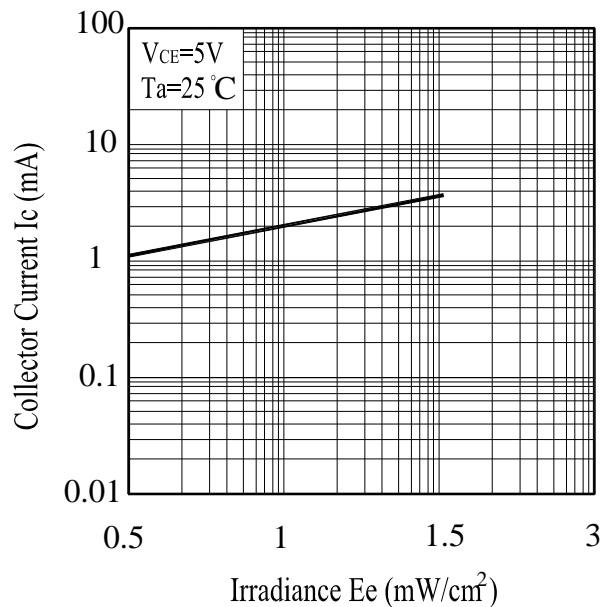

Fig.4 Collector Current vs. Irradiance



**Typical Electro-Optical Characteristics Curves**

Fig.5 Collector Dark Current vs.

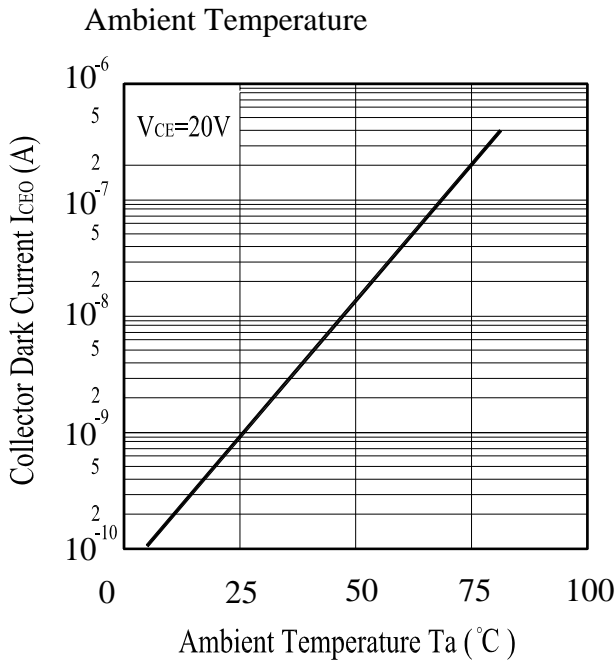
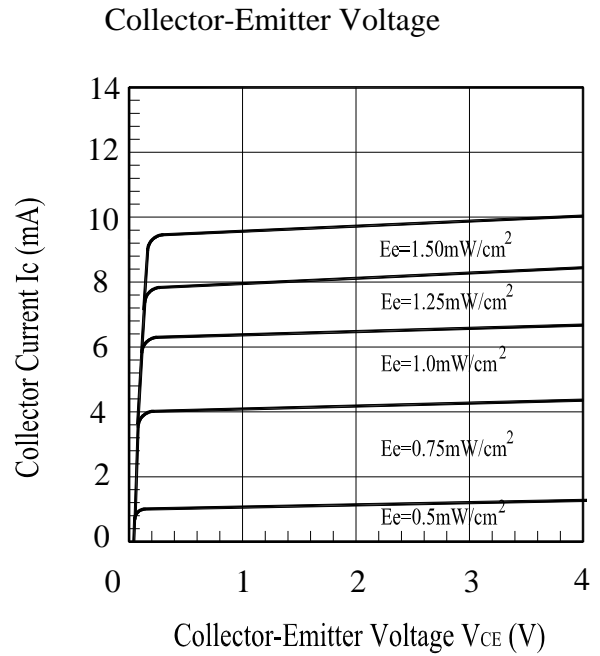

Fig.6 Collector Current vs.



**Reliability Test Item And Condition**

The reliability of products shall be satisfied with items listed below.

Confidence level : 90%

LTPD : 10%

NO.	Item	Test Conditions	Test Hours/ Cycles	Sample Sizes	Failure Judgement Criteria	Ac/Re
1	Solder Heat	TEMP. : 260°C±5°C	10secs	22pcs	$I_{C(ON)} \leq L \times 0.8$  L : Lower Specification Limit	0/1
2	Temperature Cycle	H : +100°C    15mins ↑ 5mins ↓ L : -40°C    15mins	300Cycles	22pcs		0/1
3	Thermal Shock	H : +100°C    5mins ↑ 10secs ↓ L : -10°C    5mins	300Cycles	22pcs		0/1
4	High Temperature Storage	TEMP. : +100°C	1000hrs	22pcs		0/1
5	Low Temperature Storage	TEMP. : -40°C	1000hrs	22pcs		0/1
6	DC Operating Life	V <sub>CE</sub> =5V	1000hrs	22pcs		0/1
7	High Temperature/ High Humidity	85°C / 85% R.H	1000hrs	22pcs		0/1

### **Packing Quantity Specification**

- 1.1000PCS/1Bag , 4Bags/1Box
- 2.10Boxes/1Carton

### **Label Form Specification**

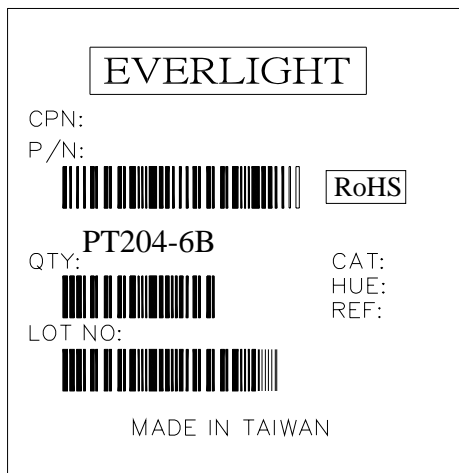

- PN: Customer's Production Number
- P/N : Production Number
- QTY: Packing Quantity
- CAT: Ranks
- HUE: Peak Wavelength
- REF: Reference
- LOT No: Lot Number
- MADE IN TAIWAN: Production Place

### **Notes**

1. Above specification may be changed without notice. EVERLIGHT will reserve authority on material change for above specification.
2. When using this product, please observe the absolute maximum ratings and the instructions for using outlined in these specification sheets. EVERLIGHT assumes no responsibility for any damage resulting from use of the product which does not comply with the absolute maximum ratings and the instructions included in these specification sheets.
3. These specification sheets include materials protected under copyright of EVERLIGHT corporation. Please don't reproduce or cause anyone to reproduce them without EVERLIGHT's consent.

<b>EVERLIGHT ELECTRONICS CO., LTD.</b>	Tel: 886-2-2267-2000, 2267-9936
Office: No 25, Lane 76, Sec 3, Chung Yang Rd,	Fax: 886-2267-6244, 2267-6189, 2267-6306
Tucheng, Taipei 236, Taiwan, R.O.C	http://www.everlight.com