

6 Watt Discrete Power GaN on SiC HEMT

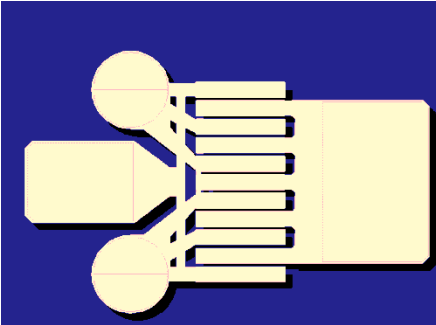

Measured Performance

Bias conditions: $V_d = 28\text{ V}$, $I_{dq} = 125\text{ mA}$, $V_g = -3.6\text{ V}$ Typical

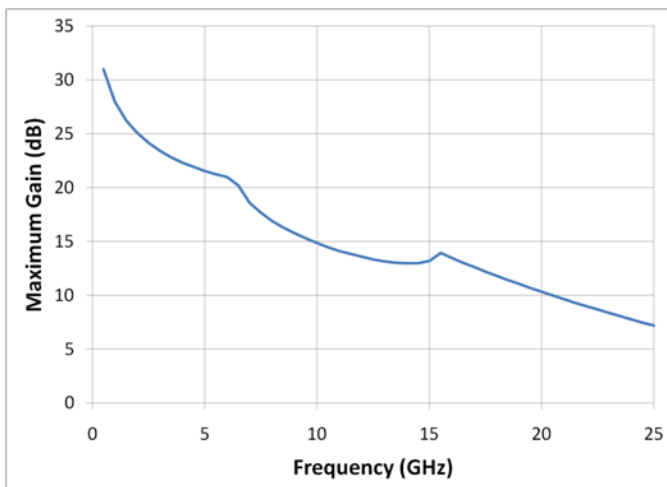

Key Features

- Frequency Range: DC - 18 GHz
- 38 dBm Nominal P_{sat} at 3 GHz
- 66% Maximum PAE
- 18 dB Nominal Power Gain at 3 GHz
- Bias: $V_d = 28 - 32\text{ V}$, $I_{dq} = 125\text{ mA}$, $V_g = -3.6\text{ V}$ Typical
- Technology: 0.25 μm Power GaN on SiC
- Chip Dimensions: 0.82 x 0.66 x 0.10 mm

Primary Applications

- Defense & Aerospace
- Broadband Wireless

Product Description

The TriQuint TGF2023-01 is a discrete 1.25 mm GaN on SiC HEMT which operates from DC-18 GHz. The TGF2023-01 is designed using TriQuint's proven 0.25 μm GaN production process. This process features advanced field plate techniques to optimize microwave power and efficiency at high drain bias operating conditions.

The TGF2023-01 typically provides 38 dBm of saturated output power with power gain of 18 dB at 3 GHz. The maximum power added efficiency is 66% which makes the TGF2023-01 appropriate for high efficiency applications.

Lead-free and RoHS compliant

Datasheet subject to change without notice.

Table I
Absolute Maximum Ratings 1/

Symbol	Parameter	Value	Notes
Vd	Drain Voltage	40 V	<u>2/</u>
Vg	Gate Voltage Range	-50 to 0 V	
Vdg	Drain-Gate Voltage	80 V	
Id	Drain Current	1.25 A	<u>2/</u>
Ig	Gate Current	7 mA	
Pin	Input Continuous Wave Power	31 dBm	<u>2/</u>
Tch	Channel Temperature	200 °C	

1/ These ratings represent the maximum operable values for this device. Stresses beyond those listed under “Absolute Maximum Ratings” may cause permanent damage to the device and / or affect device lifetime. These are stress ratings only, and functional operation of the device at these conditions is not implied.

2/ Combinations of supply voltage, supply current, input power, and output power shall not exceed the maximum power dissipation listed in Table IV.

Table II
Recommended Operating Conditions

Symbol	Parameter	Value
Vd	Drain Voltage	28 - 32 V
Idq	Drain Current	125 mA
Id_Drive	Drain Current under RF Drive, Typical	400 mA
Vg	Gate Voltage, Typical	-3.6 V

Table III
RF Characterization 1/

Bias: Vd = 28 V, Idq = 125 mA, Vg = -3.6V Typical

SYMBOL	PARAMETER	3 GHz	6 GHz	10 GHz	14 GHz	UNITS
Power Tuned:						
Psat	Saturated Output Power	38.1	37.5	37.4	36.1	dBm
PAE	Power Added Efficiency	60	58	52	42	%
Gain	Power Gain	18.4	12.7	10.4	7.1	dB
Rp <u>2/</u>	Parallel Resistance	79.3	81.9	61.5	49.9	Ω -mm
Cp <u>2/</u>	Parallel Capacitance	0.524	0.348	0.426	0.432	pF/mm
Γ_L <u>3/</u>	Load Reflection Coefficient	0.34 \angle 90	0.44 \angle 99	0.64 \angle 130	0.73 \angle 143	-
Efficiency Tuned:						
Psat	Saturated Output Power	36.8	35.8	37.1	36.1	dBm
PAE	Power Added Efficiency	66	66	54	43	%
Gain	Power Gain	17.7	13.3	10.7	7.0	dB
Rp <u>2/</u>	Parallel Resistance	153	171	72.1	53.1	Ω -mm
Cp <u>2/</u>	Parallel Capacitance	0.426	0.372	0.414	0.472	pF/mm
Γ_L <u>3/</u>	Load Reflection Coefficient	0.51 \angle 60	0.67 \angle 87	0.66 \angle 126	0.77 \angle 144	-

1/ Values in this table are measured on a 1.25 mm GaN/SiC unit

2/ Large signal equivalent output network (normalized) (see figure, pg 11)

3/ Optimum Gamma_Load (Γ_L) for maximum power or maximum PAE

Table IV
Power Dissipation and Thermal Properties 1/

Parameter	Test Conditions	Value	Notes
Maximum Power Dissipation	Tbaseplate = 70 °C	Pd = 8.1 W Tchannel = 200 °C Tm = 1.5E+6 Hrs	<u>2/</u>
Thermal Resistance, θ_{jc}	Vd = 28 V Id = 125 mA Pd = 3.5 W Tbaseplate = 70 °C	θ_{jc} = 16.0 (°C/W) Tchannel = 126 °C Tm = 6.4E+8 Hrs	
Thermal Resistance, θ_{jc} Under RF Drive	Vd = 28 V Id = 379 mA Pout = 38.1 dBm Pd = 4.2 W Tbaseplate = 70 °C	θ_{jc} = 16.0 (°C/W) Tchannel = 139 °C Tm = 2.1E+8 Hrs	
Mounting Temperature	30 Seconds	320 °C	
Storage Temperature		-65 to 150 °C	

1/ Assumes eutectic attach using 1mil thick 80/20 AuSn mounted to a 10mil CuMo Carrier Plate

2/ Channel operating temperature will directly affect the device median lifetime. For maximum life, it is recommended that channel temperatures be maintained at the lowest possible levels.

Median Lifetime vs Channel Temperature

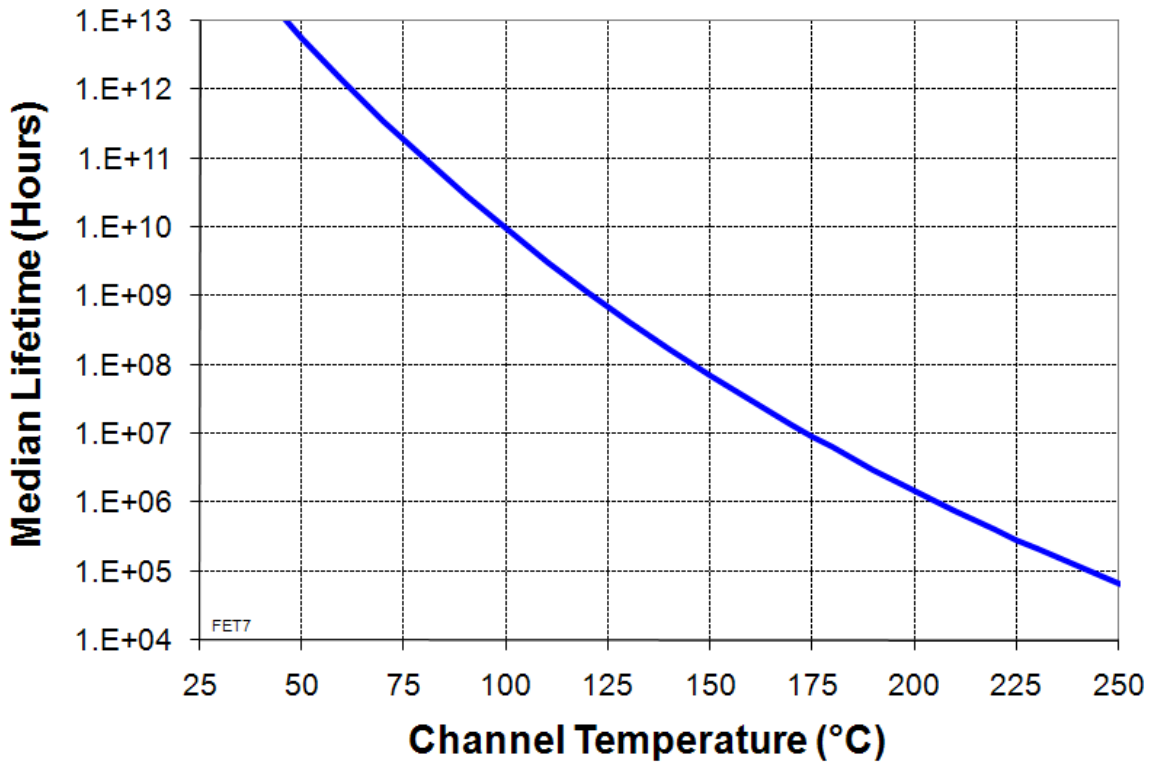

Measured Data

Bias conditions: $V_d = 28\text{ V}$, $I_{dQ} = 125\text{ mA}$, $V_g = -3.6\text{ V}$ Typical

Power tuned data at 3GHz

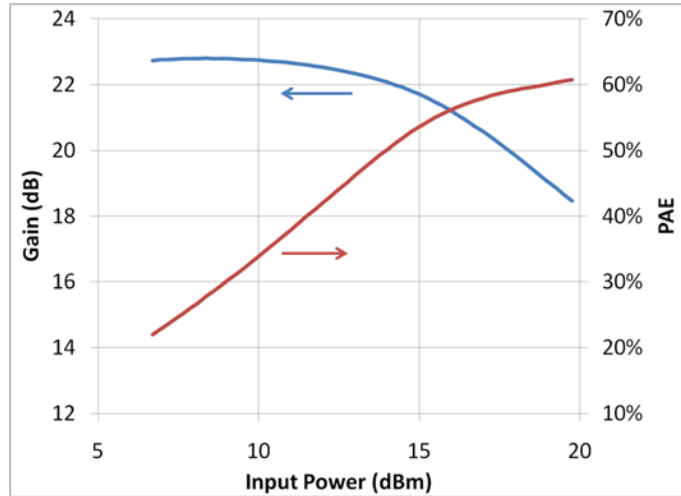
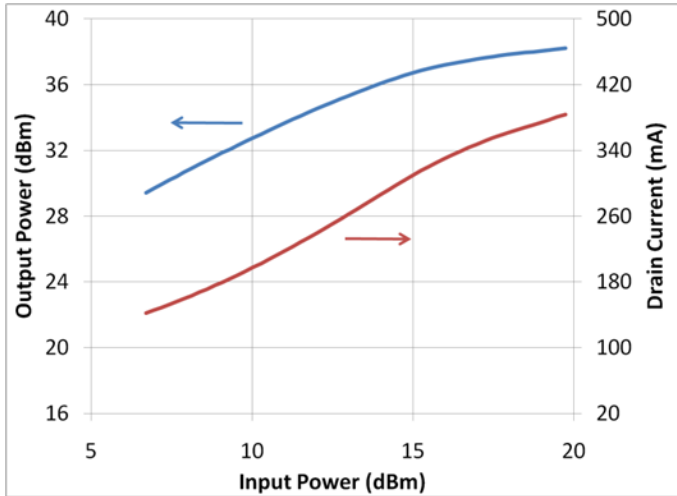

For power tuned devices at 3GHz:
 1.25mm device is input matched for maximum gain & the output load is:
 $V_d=28\text{V}$: $R_p = 79.3\ \Omega\text{-mm}$, $C_p = 0.524\ \text{pF/mm}$, $\Gamma = 0.345$, $\theta = 90.1^\circ$

Efficiency tuned data at 3GHz

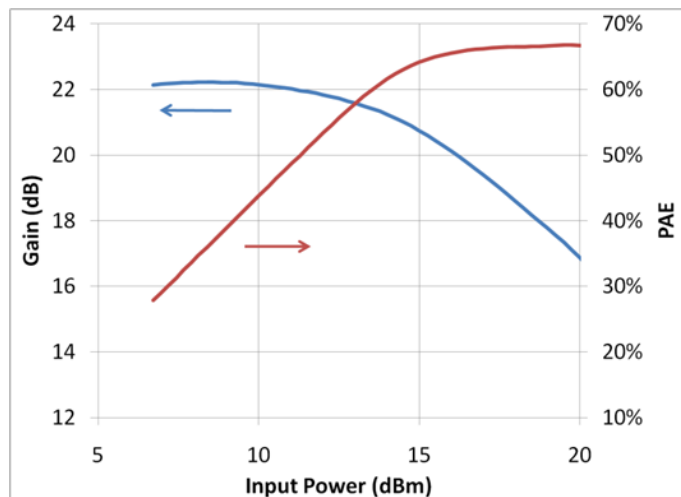
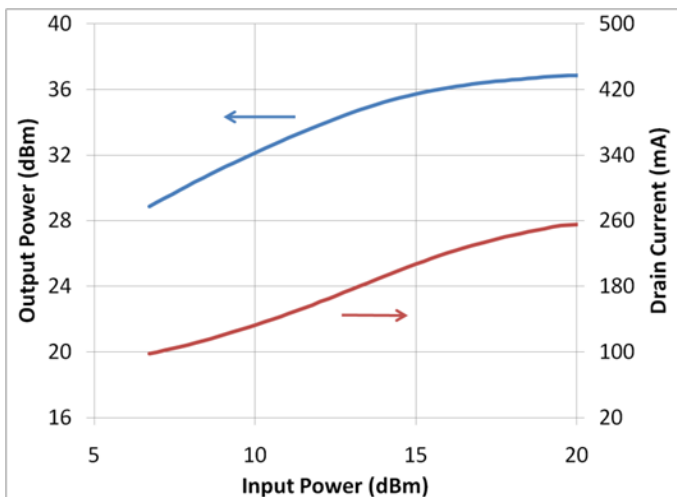

For efficiency tuned devices at 3GHz:
 1.25mm device is input matched for maximum gain & the output load is:
 $V_d=28\text{V}$: $R_p = 153\ \Omega\text{-mm}$, $C_p = 0.426\ \text{pF/mm}$, $\Gamma = 0.519$, $\theta = 59.9^\circ$

Measured Data

Bias conditions: $V_d = 28\text{ V}$, $I_{dQ} = 125\text{ mA}$, $V_g = -3.6\text{ V}$ Typical

Power tuned data at 6GHz

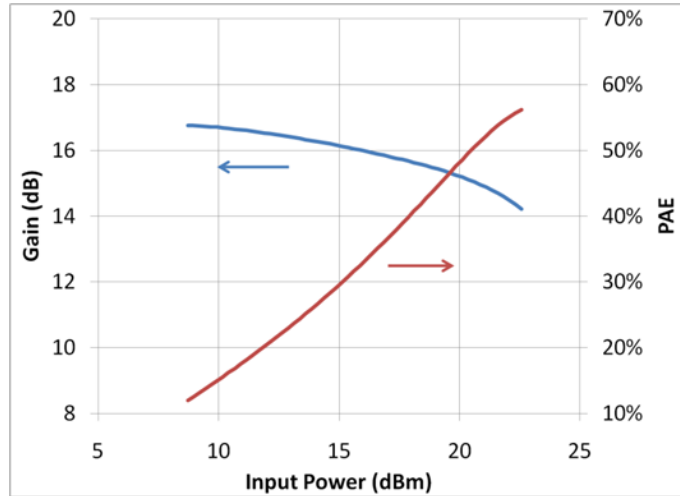
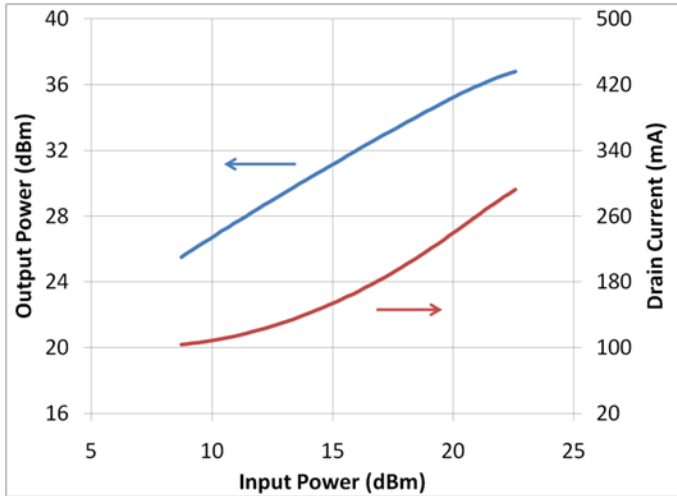

For power tuned devices at 6GHz:
1.25mm device is input matched for maximum gain & the output load is:
 $V_d=28V$: $R_p = 81.9\ \Omega\text{-mm}$, $C_p = 0.348\ \text{pF/mm}$, $\Gamma = 0.439$, $\theta = 98.8^\circ$

Efficiency tuned data at 6GHz

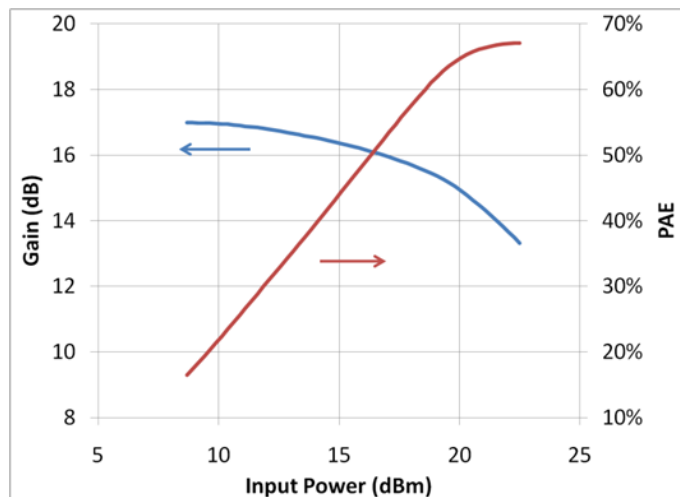
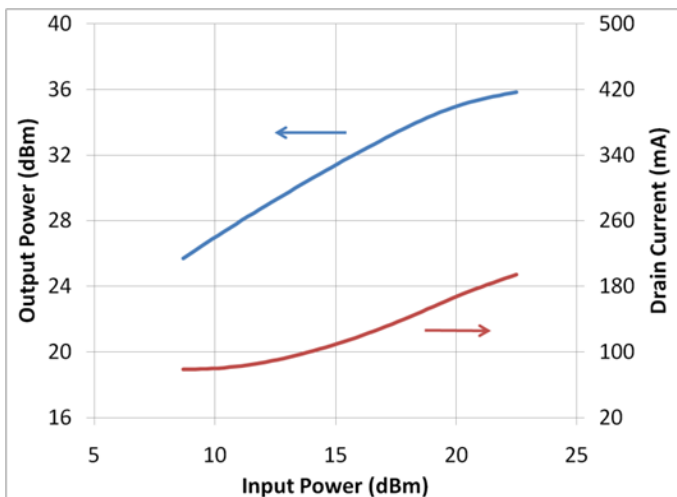

For efficiency tuned devices at 6GHz:
1.25mm device is input matched for maximum gain & the output load is:
 $V_d=28V$: $R_p = 171\ \Omega\text{-mm}$, $C_p = 0.372\ \text{pF/mm}$, $\Gamma = 0.667$, $\theta = 86.7^\circ$

Measured Data

Bias conditions: $V_d = 28\text{ V}$, $I_{dQ} = 125\text{ mA}$, $V_g = -3.6\text{ V}$ Typical

Power tuned data at 10GHz

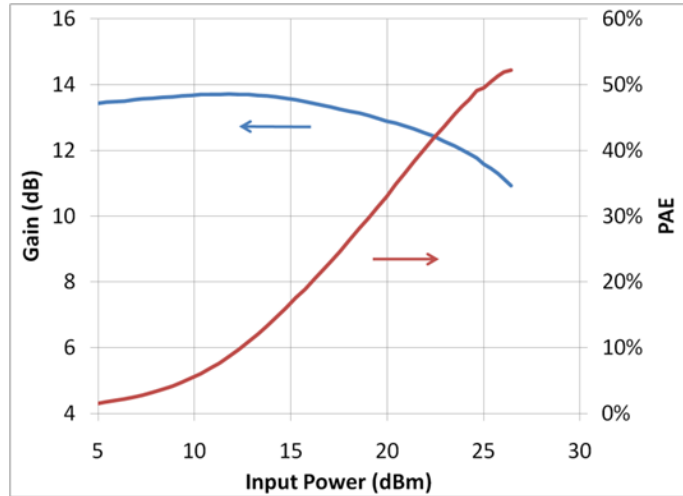
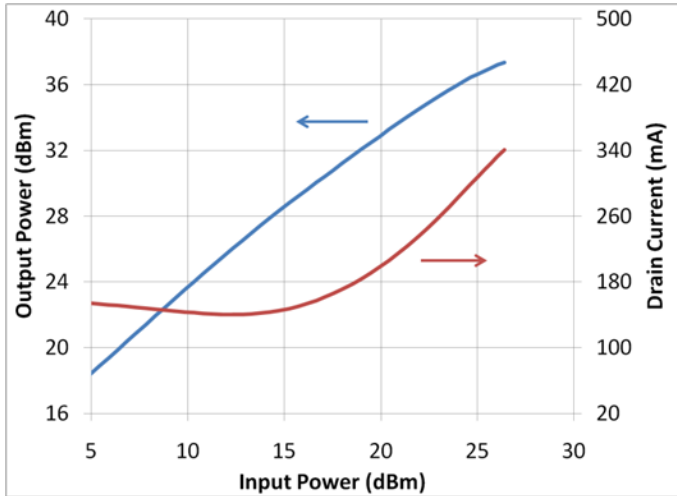

For power tuned devices at 10GHz:
 1.25mm device is input matched for maximum gain & the output load is:
 $V_d=28\text{V}$: $R_p = 61.5\ \Omega\text{-mm}$, $C_p = 0.426\ \text{pF/mm}$, $\Gamma = 0.639$, $\theta = 130^\circ$

Efficiency tuned data at 10GHz

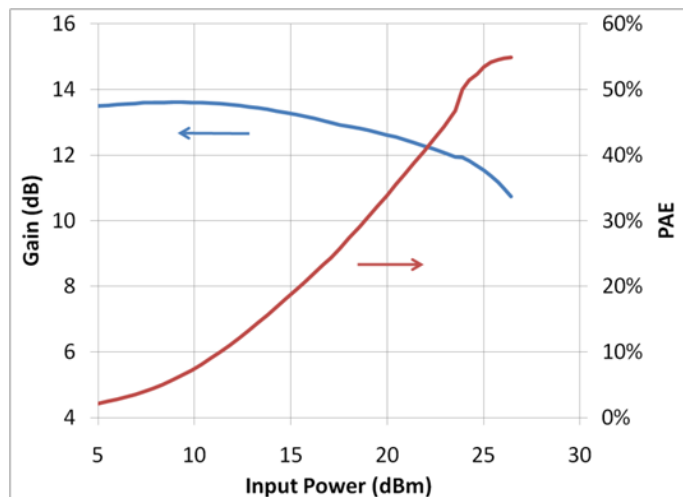
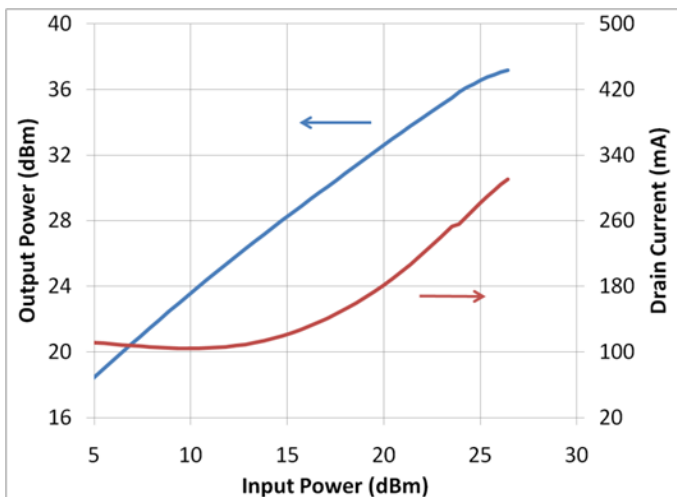

For efficiency tuned devices at 10GHz:
 1.25mm device is input matched for maximum gain & the output load is:
 $V_d=28\text{V}$: $R_p = 72.1\ \Omega\text{-mm}$, $C_p = 0.414\ \text{pF/mm}$, $\Gamma = 0.659$, $\theta = 126^\circ$

Measured Data

Bias conditions: $V_d = 28\text{ V}$, $I_{dQ} = 125\text{ mA}$, $V_g = -3.6\text{ V}$ Typical

Power tuned data at 14GHz

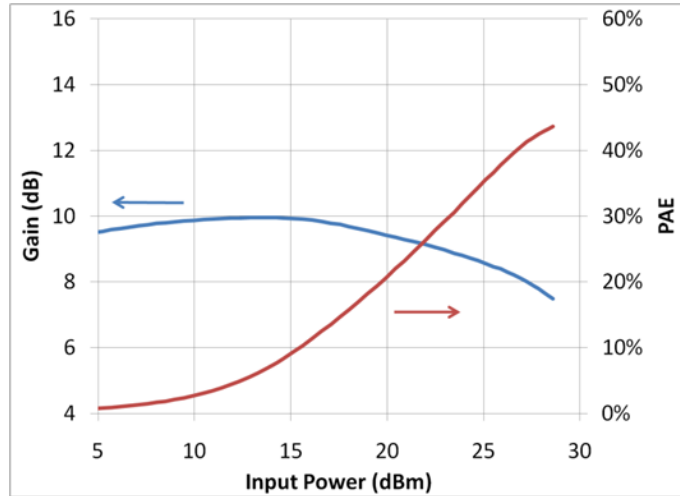
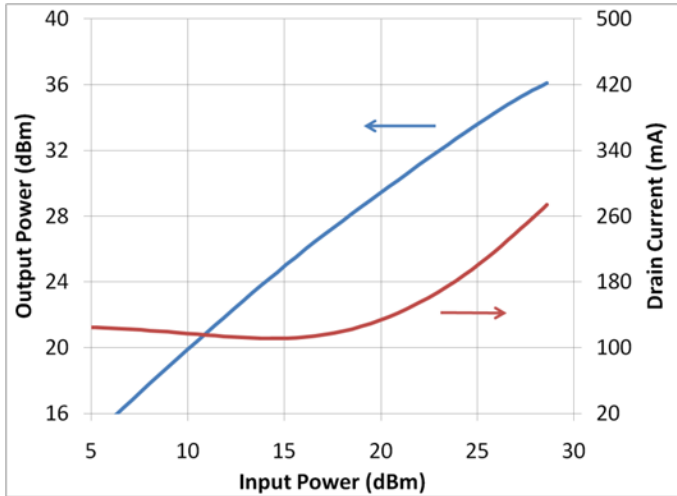

For power tuned devices at 14GHz:
 1.25mm device is input matched for maximum gain & the output load is:
 $V_d=28\text{V}$: $R_p = 49.9\ \Omega\text{-mm}$, $C_p = 0.432\ \text{pF/mm}$, $\Gamma = 0.73$, $\theta = 143^\circ$

Efficiency tuned data at 14GHz

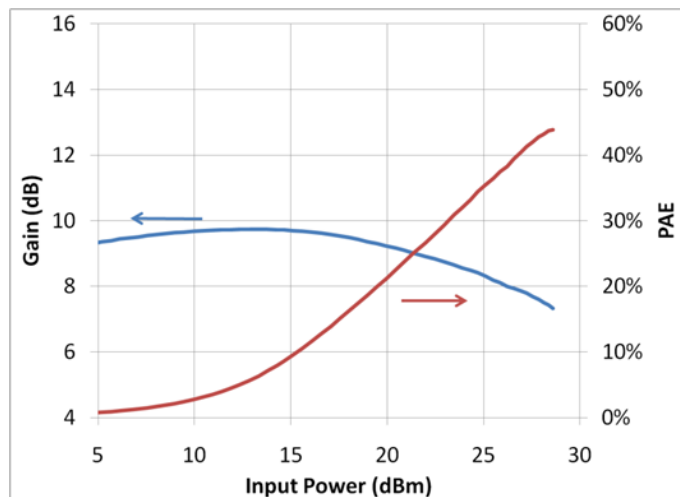
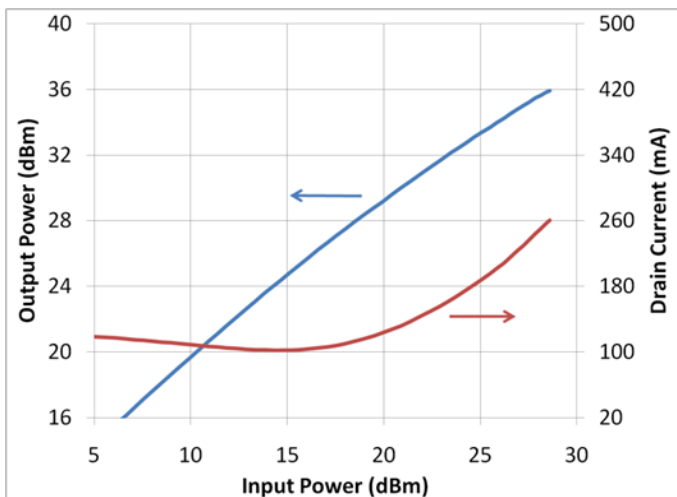

For efficiency tuned devices at 14GHz:
 1.25mm device is input matched for maximum gain & the output load is:
 $V_d=28\text{V}$: $R_p = 53.1\ \Omega\text{-mm}$, $C_p = 0.472\ \text{pF/mm}$, $\Gamma = 0.768$, $\theta = 144^\circ$

Linear Model for 1.25 mm Unit GaN Cell (UGC)

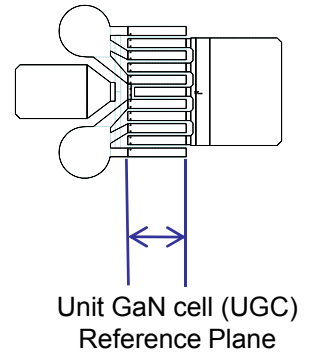
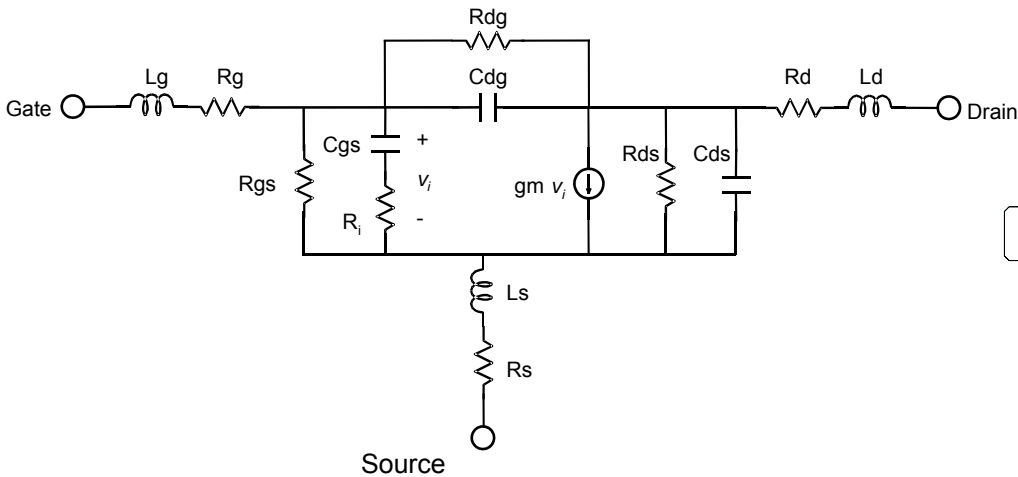

MODEL PARAMETER	Vd=28V Idq=125mA	UNITS
Rg	0.78	Ω
Rs	0.13	Ω
Rd	1.28	Ω
gm	0.270	S
Cgs	1.79	pF
Ri	0.26	Ω
Cds	0.308	pF
Rds	123.6	Ω
Cgd	0.064	pF
Tau	2.78	pS
Ls	0.0058	nH
Lg	-0.013	nH
Ld	0.018	nH
Rgs	8900	Ω
Rgd	1730000	Ω

Complete 1.25 mm GaN HEMT Linear Model

Includes 1 UGC, 2 vias, and 2 bonding pads

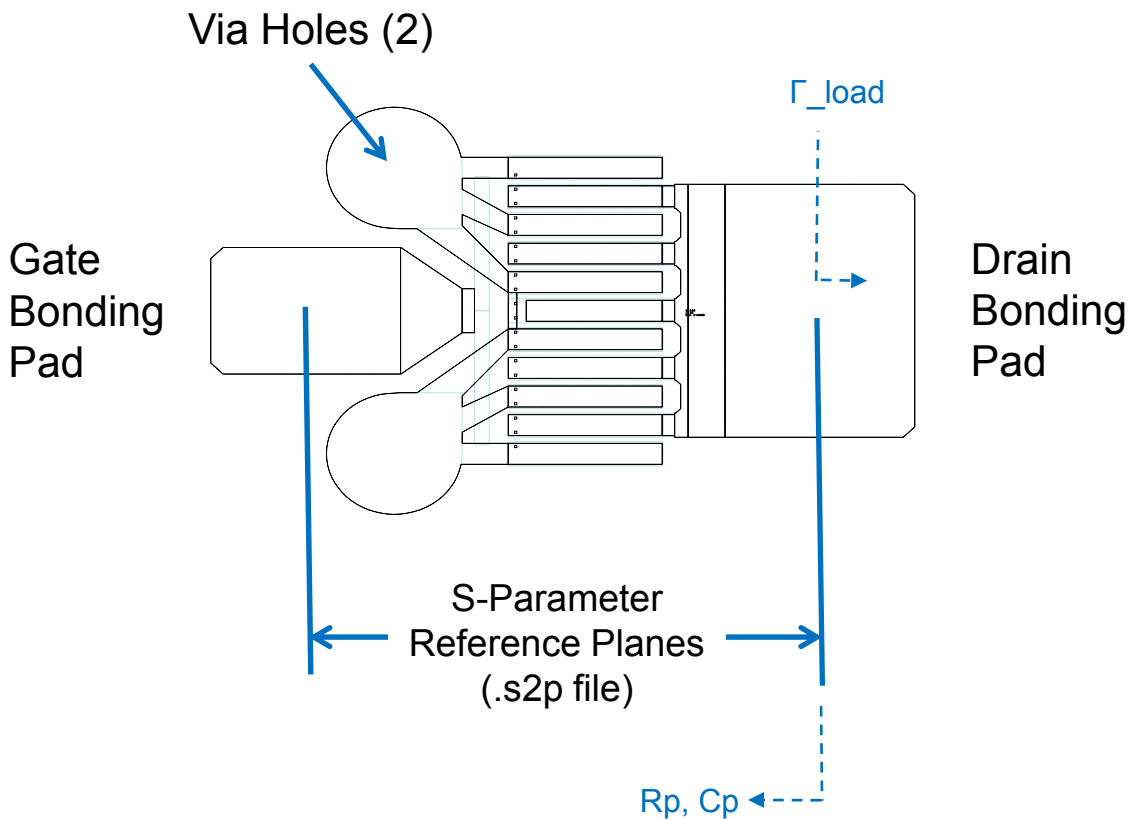

Mechanical Drawing

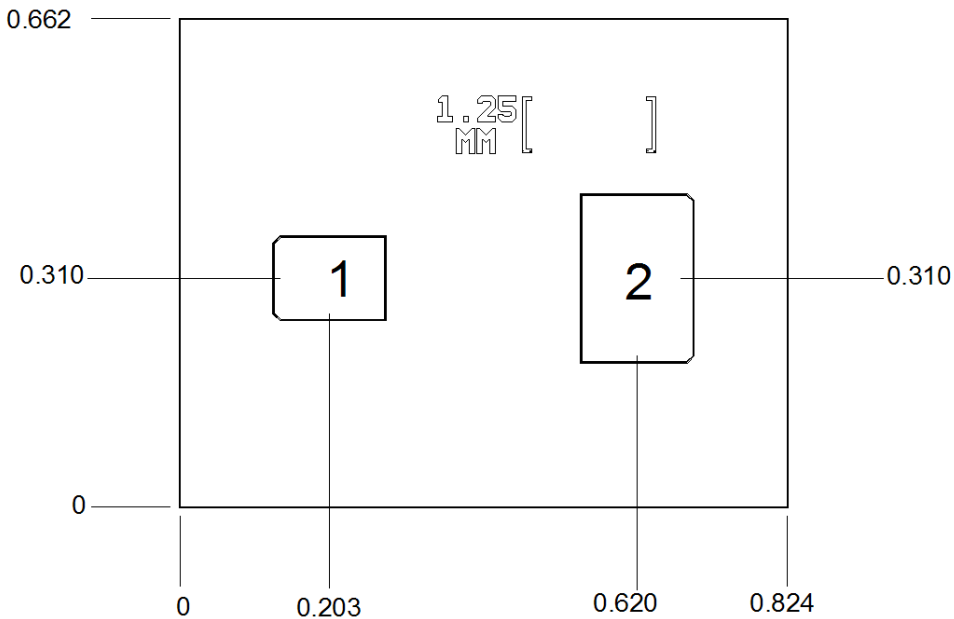

Units: millimeters

Thickness: 0.100

Die x,y size tolerance: +/- 0.050

Chip edge to bond pad dimensions are shown to center of pad

Ground is backside of die

Bond Pad #1	Vg	0.154 x 0.115
Bond Pad #2	Vd	0.154 x 0.230

GaAs MMIC devices are susceptible to damage from Electrostatic Discharge. Proper precautions should be observed during handling, assembly and test.

Assembly Notes

Component placement and adhesive attachment assembly notes:

- Vacuum pencils and/or vacuum collets are the preferred method of pick up.
- Air bridges must be avoided during placement.
- The force impact is critical during auto placement.
- Organic attachment (i.e. epoxy) can be used in low-power applications.
- Curing should be done in a convection oven; proper exhaust is a safety concern.

Reflow process assembly notes:

- Use AuSn (80/20) solder and limit exposure to temperatures above 300°C to 3-4 minutes, maximum.
- An alloy station or conveyor furnace with reducing atmosphere should be used.
- Do not use any kind of flux.
- Coefficient of thermal expansion matching is critical for long-term reliability.
- Devices must be stored in a dry nitrogen atmosphere.

Interconnect process assembly notes:

- Ball bonding is the preferred interconnect technique, except where noted on the assembly diagram.
- Force, time, and ultrasonics are critical bonding parameters.
- Aluminum wire should not be used.
- Devices with small pad sizes should be bonded with 0.0007-inch wire.

Ordering Information

Part	ECCN	Package Style
TGF2023-01	EAR99	GaN on SiC Die

GaAs MMIC devices are susceptible to damage from Electrostatic Discharge. Proper precautions should be observed during handling, assembly and test.