

0.4 mm Contact Pitch, Stacking Height 0.8 mm Board-to-Board/Board-to-FPC Connector

BM20 Series

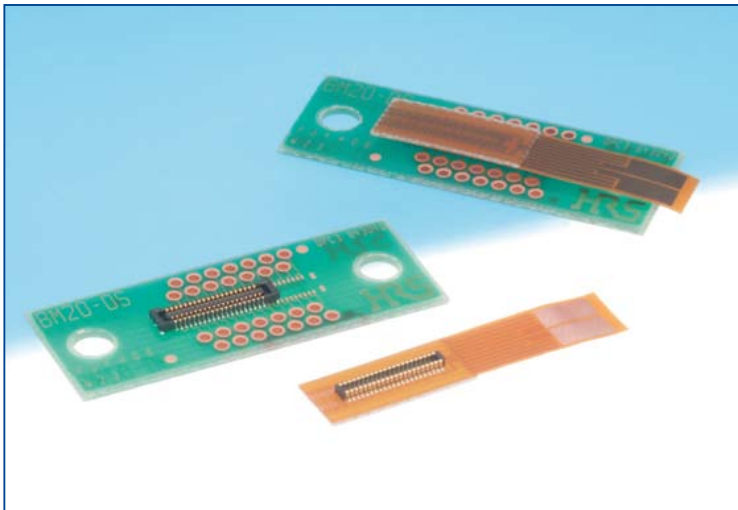

■ Features

1. Contributes to High-Density Mounting of the Unit

Space-saving design with the minimum connector width, while securing absorption area that does not affect mounting capability (confirmed by mounting).

Width DS: 2.3 mm DP: 1.78mm

2. High Contact Reliability

Connector has the effective mating length of 0.2 mm, the longest length class for the mating height of 0.8 mm. In addition, the two-point contact structure is adopted to secure high contact reliability.

3. No Pattern Prohibition Area

No restrictions on pattern designing, as thin molding technology maintains the effective mating length of 0.2 mm while achieving complete insulation between the bottom side of the connector and the board.

4. Good Mating Operability

Mating self-alignment of 0.3 mm is secured by the guide ribs. Giving a clicking feeling which is effective in preventing incomplete mating, the connector contributes to the enhanced mating operability.

5. Solid Structure with Shock-Absorbing Contacts

Lock structure at the plug terminal absorbs stress when exposed to impact.

6. Splatter-Proof, Safe Structure

The contact areas of both connectors are surrounded by walls, preventing the adherence of splatter such as flux to the contact area.

■ Application

Devices that need to be slim and compact such as cell phones and tablet PCs.

■ Receptacle

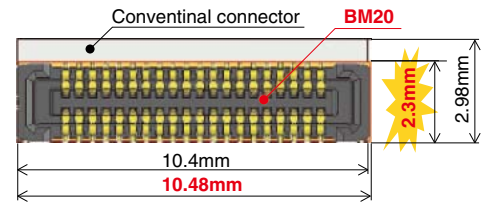

Conventional connector	BM20
2.98 × 10.4 =Approx. 30.4mm ²	2.3 × 10.48 =Approx. 24.1mm ²

Approx. 20.7% Reduction

■ Header

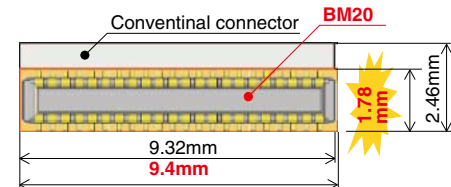

The board-occupied area.

Conventional connector	BM20
2.46 × 9.32 =Approx. 22.9mm ²	1.78 × 9.4 =Approx. 16.7mm ²

Approx. 20.7% Reduction

Absorption Area

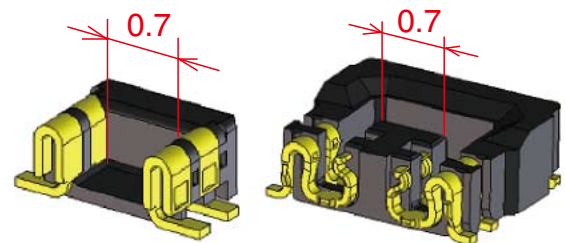

Mating Cross-Section Diagram

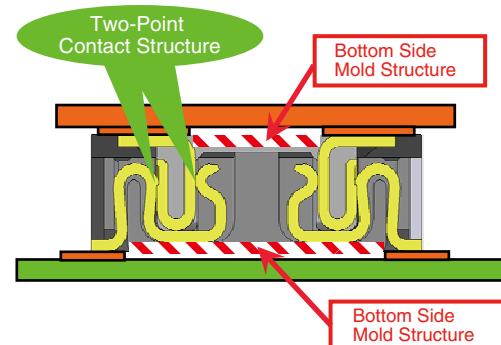

Bottom face mold structure ensures the insulation between the connector's bottom side and the board.

Specifications

Ratings	Current rating	0.3 A	Operating temperature range	-35°C to +85°C (Note 1)	Storage temperature range	-10°C to +60°C (Note 2)
	Voltage rating	30 V AC, DC	Operating humidity range	RH 20% to 80%	Storage humidity range	RH 40% to 70% (Note 2)

Item	Specification	Conditions
1. Insulation resistance	50 MΩ min	100 V DC
2. Withstanding voltage	No flashover or insulation breakdown	100 V AC / 1minute
3. Contact resistance	100 mΩ max.	20 mV AC, 1 kHz, 1 mA
4. Vibration	No electrical discontinuity of 1 μs or longer No damage or parts dislocation	Frequency: 10 to 55 Hz, 5 min, single amplitude of 0.75 mm, 10 cycles, for each directions.
5. Humidity	Contact resistance: 100 mΩ max., Insulation resistance: 25 MΩ min.	96 hours at 40 ±2°C and humidity of 90 to 95% No damage or parts dislocation
6. Temperature cycle	Contact resistance: 100 mΩ max., Insulation resistance: 50 MΩ min. No damage or parts dislocation	-55°C → 5 to 35°C → 85°C → 5 to 35°C Time: 30 min. → 10 min. → 30 min. → 10 min. 5 cycles
7. Durability	Contact resistance: 100 mΩ max.	10 cycles
8. Resistance to soldering heat	No deformation of components affecting performance	Reflow: At the recommended temperature profile Manual soldering: 350°C for 3 seconds

Note 1: Includes temperature rise caused by current flow.

Note 2: The term "storage" here refers to products stored for a long period prior to board mounting and use.

The operating temperature and humidity range covers the non-conducting condition of connectors after board mounting and the temporary storage conditions of transportation, etc.

Note 3: Information contained in this catalog represents general requirements for this Series. Contact us for the drawings and specifications for a specific part number shown.

Material

Product	Part	Material	Finish	Remarks
Receptacle	Insulator	LCP	Color:Black	UL94V-0
Header	Contacts	Phosphor bronze	Gold plated	—

Ordering information

● Receptacles / Headers

BM 20 B (0.8) - * DS - 0.4 V (51)

① ② ③ ④ ⑤ ⑥ ⑦ ⑧ ⑨

① Series name : BM	⑥ Connector style DS:Double-row receptacle DP:Double-row header
② Series No.: 20	
③ Configuration Receptacle B:With mettal fittings Header B:With mettal fittings	⑦ Contact pitch : 0.4mm
④ Stacking Height: 0.8mm	⑧ Termination type V...SMT vertical mount
⑤ Number of contacts:20, 24, 30, 40, 44, 50, 60	
	⑨ Packaging (51): Embossed tape packaging (8,000 pieces per reel)

Receptacles

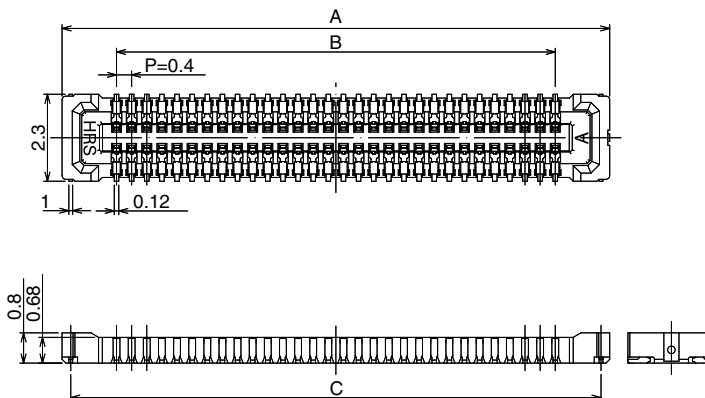
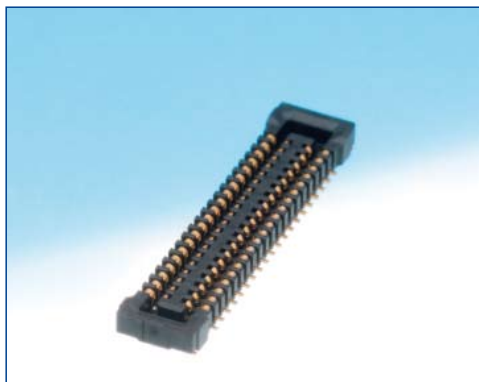

Recommended PCB mounting pattern

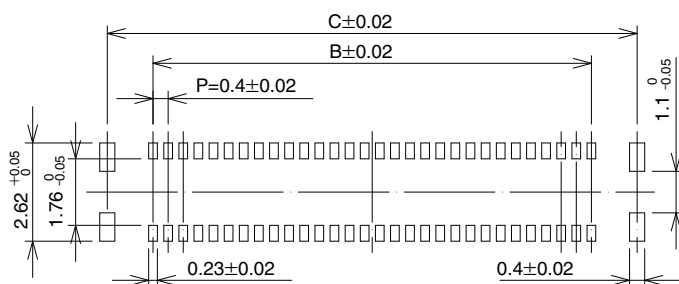

Recommended metal mask dimensions

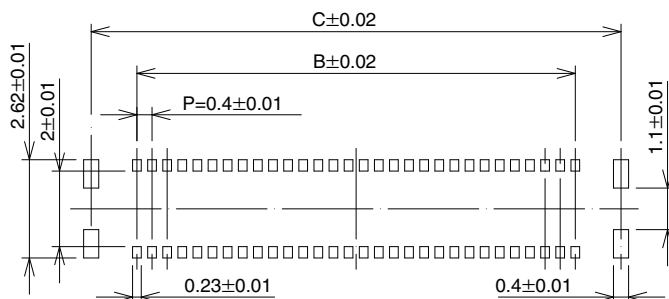

All dimensions: mm

Part Number	CL No.	Number of Contacts	A	B	C
BM20B(0.8)-20DS-0.4V(51)	CL0684-9009-7-51	20	6.48	3.6	6.02
BM20B(0.8)-24DS-0.4V(51)	CL0684-9010-6-51	24	7.28	4.4	6.82
BM20B(0.8)-30DS-0.4V(51)	CL0684-9011-9-51	30	8.48	5.6	8.02
BM20B(0.8)-40DS-0.4V(51)	CL0684-9012-1-51	40	10.48	7.6	10.02
BM20B(0.8)-44DS-0.4V(51)	CL0684-9017-5-51	44	11.28	8.4	10.82
BM20B(0.8)-50DS-0.4V(51)	CL0684-9013-4-51	50	12.48	9.6	12.02
BM20B(0.8)-60DS-0.4V(51)	CL0684-9014-7-51	60	14.48	11.6	14.02

Note 1 : Order by number of reels.

Note 2 : This connector is NOT polarized.

Headers

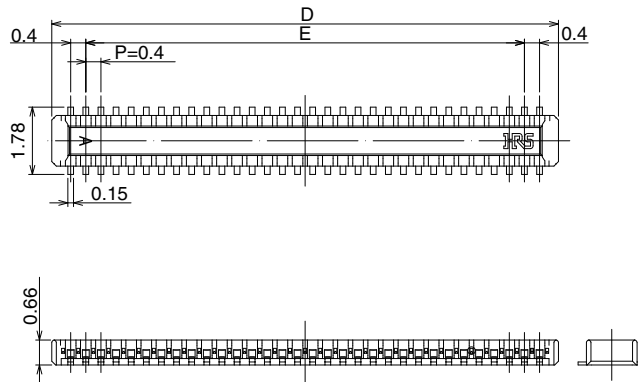
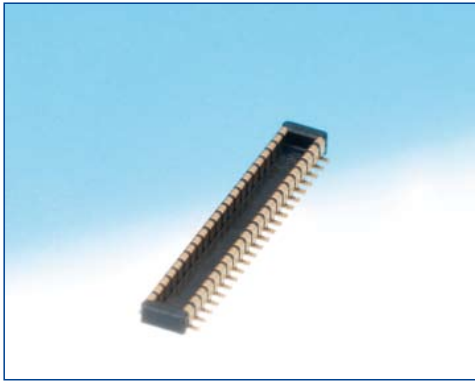

Recommended PCB mounting pattern

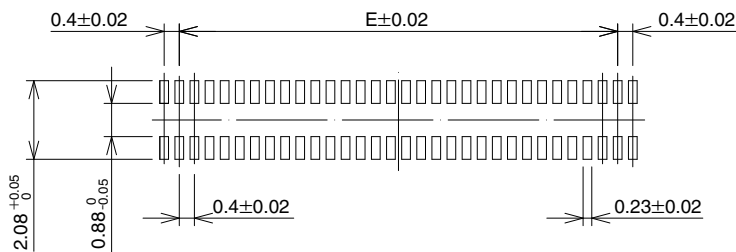

Recommended metal mask dimensions

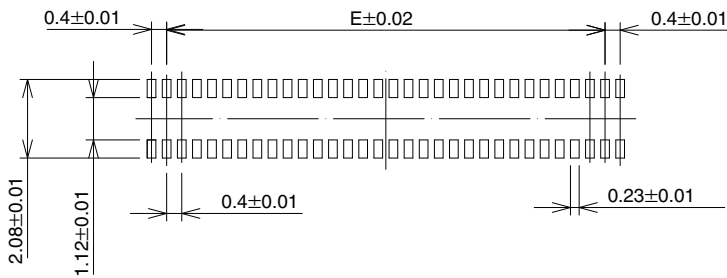

All dimensions: mm

Part Number	CL No.	Number of Contacts	D	E
BM20B(0.8)-20DP-0.4V(51)	CL0684-9002-8-51	20	5.4	3.6
BM20B(0.8)-24DP-0.4V(51)	CL0684-9003-0-51	24	6.2	4.4
BM20B(0.8)-30DP-0.4V(51)	CL0684-9004-3-51	30	7.4	5.6
BM20B(0.8)-40DP-0.4V(51)	CL0684-9005-6-51	40	9.4	7.6
BM20B(0.8)-44DP-0.4V(51)	CL0684-9016-2-51	44	10.2	8.4
BM20B(0.8)-50DP-0.4V(51)	CL0684-9006-9-51	50	11.4	9.6
BM20B(0.8)-60DP-0.4V(51)	CL0684-9007-1-51	60	13.4	11.6

Note 1 : Order by number of reels.

Note 2 : This connector is NOT polarized.

■ Embossed Carrier Tape Dimensions

● Receptacle

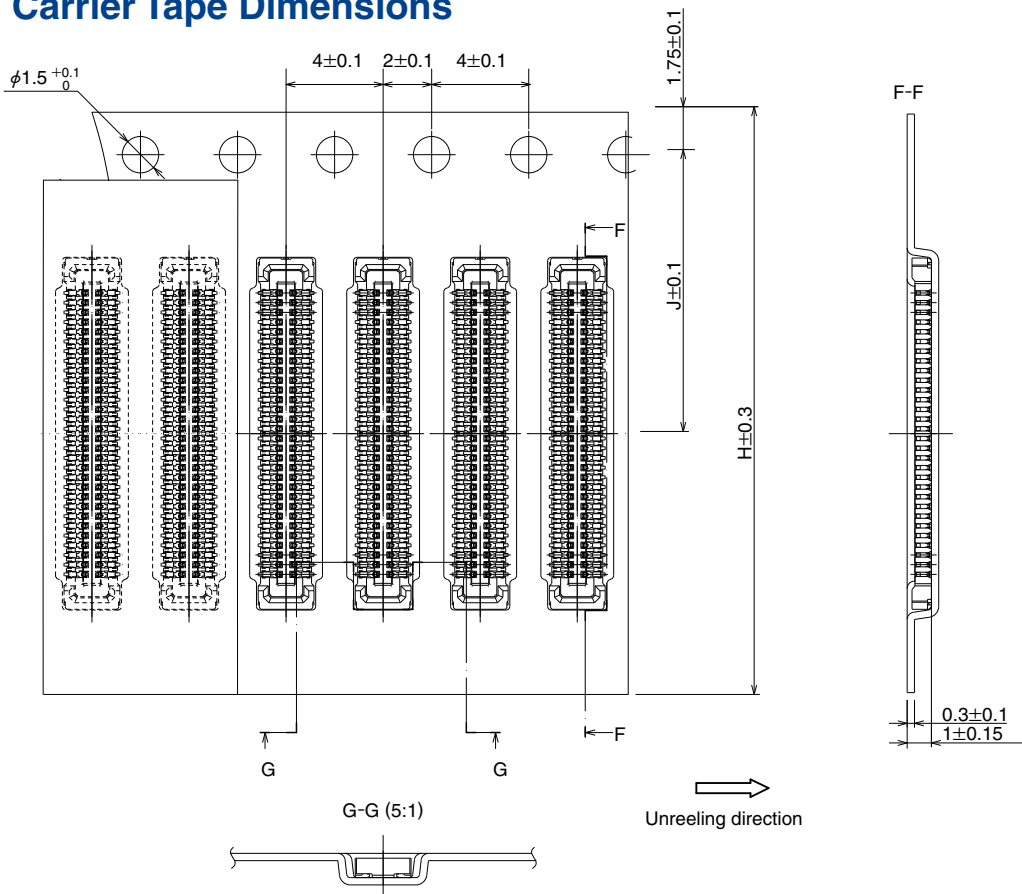

■ Reel dimensions

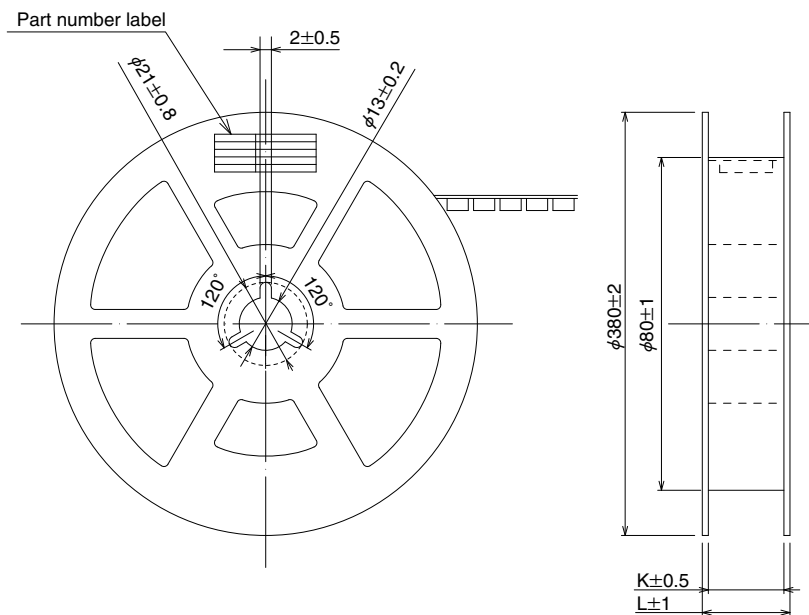

All dimensions: mm

Part Number	H	J	K	L
BM20B(0.8)-20DS-0.4V(51)	16	7.5	17.5	21.5
BM20B(0.8)-24DS-0.4V(51)	16	7.5	17.5	21.5
BM20B(0.8)-30DS-0.4V(51)	24	11.5	25.5	29.5
BM20B(0.8)-40DS-0.4V(51)	24	11.5	25.5	29.5
BM20B(0.8)-44DS-0.4V(51)	24	11.5	25.5	29.5
BM20B(0.8)-50DP-0.4V(51)	24	11.5	25.5	29.5
BM20B(0.8)-60DS-0.4V(51)	24	11.5	25.5	29.5

Embossed Carrier Tape Dimensions

Header

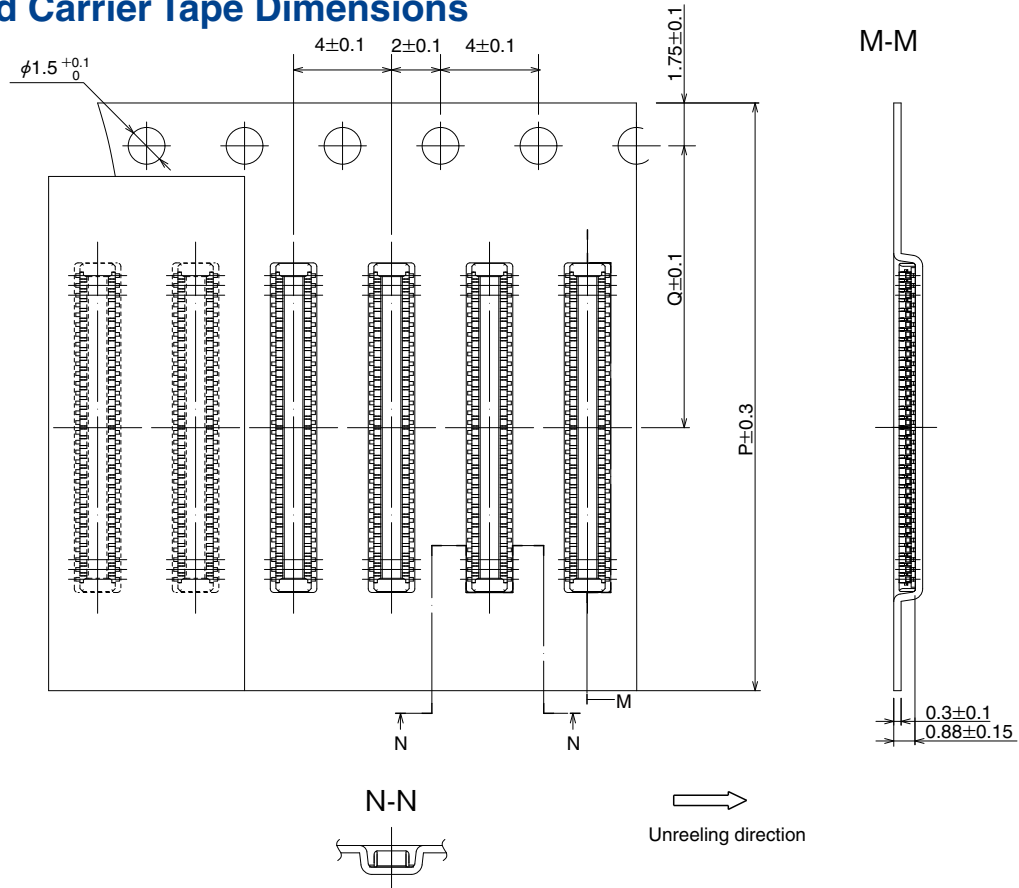

Reel dimensions

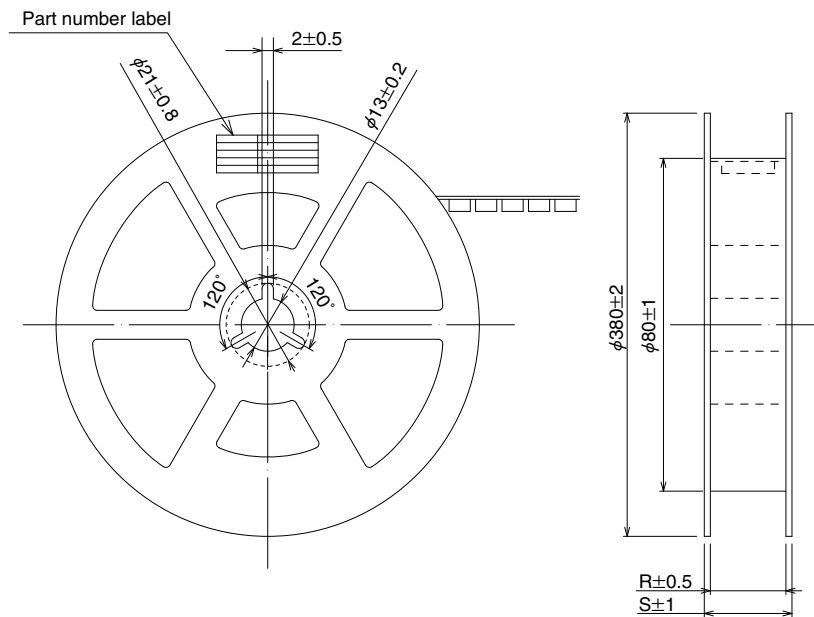

All dimensions: mm

Part Number	P	Q	R	S
BM20B(0.8)-20DP-0.4V(51)	16	7.5	17.5	21.5
BM20B(0.8)-24DP-0.4V(51)	16	7.5	17.5	21.5
BM20B(0.8)-30DP-0.4V(51)	16	7.5	17.5	21.5
BM20B(0.8)-40DP-0.4V(51)	24	11.5	25.5	29.5
BM20B(0.8)-44DP-0.4V(51)	24	11.5	25.5	29.5
BM20B(0.8)-50DP-0.4V(51)	24	11.5	25.5	29.5
BM20B(0.8)-60DP-0.4V(51)	24	11.5	25.5	29.5

Usage Recommendations

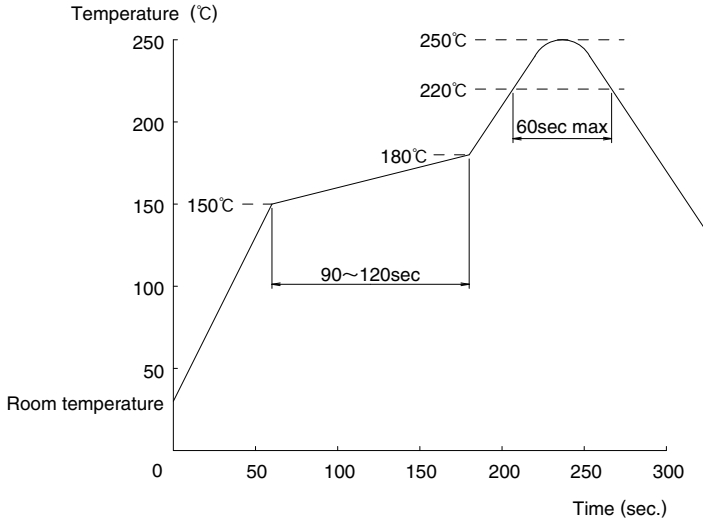
<p>1.Recommended temperature profile</p>	 <p>Note 1: Up to 2 cycles of Reflow soldering are possible under the same conditions, provided that there is a return to normal temperature between the first and second cycle.</p> <p>Note 2: For the use of N₂ reflow, oxygen density with 1,000 ppm or higher is recommended. Consult Hirose for the condition less than 1,000 ppm.</p>
<p>2.Recommended manual soldering</p>	<p>Manual soldering: 340±10°C for 3 seconds</p>
<p>3.Recommended screen thickness and open area ratio (Pattern area ratio)</p>	<p>Thickness: 0.1mm Open area ratio: Receptacle side 70%, Header side 80%</p>
<p>4.Board warpage</p>	<p>Maximum of 0.02 mm at the connector center, with both ends of the connector as reference points.</p>
<p>5.Cleaning conditions</p>	<p>Refer to “Nylon Connector Use Handbook”.</p>
<p>6.Precautions</p>	<ul style="list-style-type: none"> ■ Mating and un-mating of the connectors when not soldered on the boards is not recommended as this may cause deformation of the terminals, damage to the contacts or insulators. ■ Mated connectors should not carry weight of the board by themselves. Provide some other support of the boards. ■ When mating/un-mating do not twist or lift by the corners. Apply the forces evenly across the entire length and width of the connectors taking care NOT to damage or deform soldered terminations. ■ Exercise extreme caution when mating/ un-mating when the connector is mounted on a nonrigid (flexible) substrate. Slight discoloration on the insulating materials will not affect form, fit or function of the connectors. ■ Do NOT pull on the flexible substrate.

■ Handling Precautions when Mating Connectors

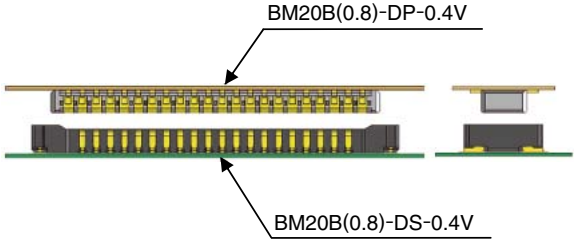
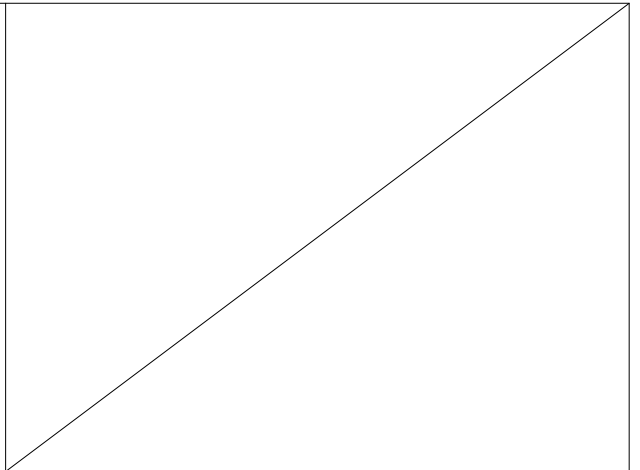
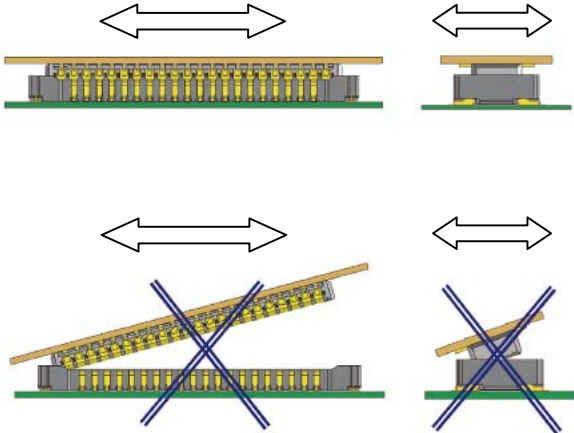
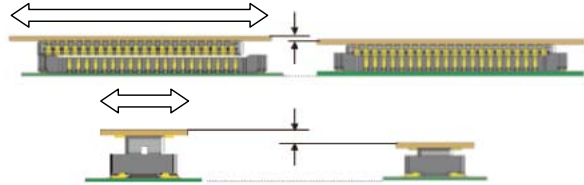
 <p>BM20B(0.8)-DP-0.4V</p> <p>BM20B(0.8)-DS-0.4V</p>	
	<p>Keep the connectors parallel to each other when positioning. The connectors will self-align in horizontal directions.</p> <p>Do not attempt to mate the connectors starting at one end or side.</p>
	<p>Press-down even until fully mated.</p>

■ Handling Precautions When Un-mating Connectors

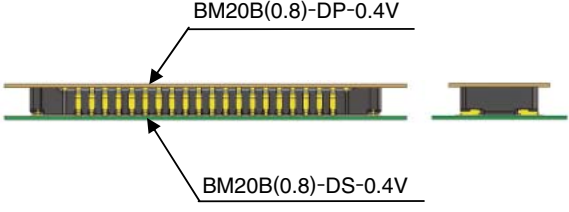
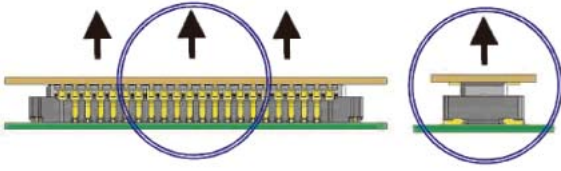
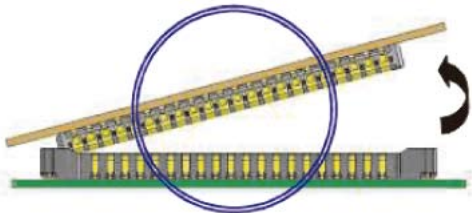
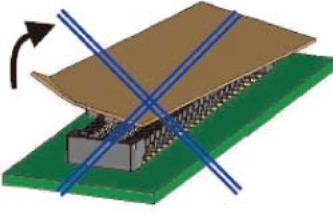
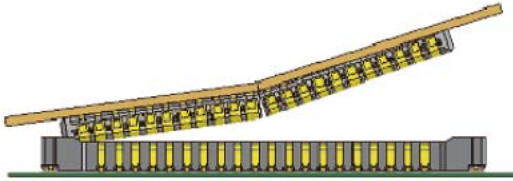
 <p>BM20B(0.8)-DP-0.4V</p> <p>BM20B(0.8)-DS-0.4V</p>	<p>Fully mated</p>
	<p>Lift even, keeping both connectors parallel to each other</p>
 <p>Pitch orientation</p>	<p>When handling, circumstances may prevent the connectors from being kept parallel when un-mating. One end may be lifted as shown. However, to use this procedure the connector must be mounted on sufficiently rigid circuit board.</p> <p>Any deflection of the board during this operation may result in damage to the connector or solder joints.</p>
 <p>Corner orientation</p>	<p>Do not attempt to start the un-mating of the connectors from one side or corner.</p> <p>Failure to exercise caution when un-mating the connectors mounted on the non-rigid FPC may also result in connector breakage.</p> <p>It is the responsibility of the user to perform verification of the repeated mating / un-mating cycles with the connectors mounted on the applicable FPC.</p>
	<p>A stiffener must be provided on FPC.</p> <p>When the rigidity of the FPC is low, there is a risk that the connector could break as illustrated in the diagram at left.</p> <p>Please use the connectors after performing a check of repeated operation with the FPC that the customer will be using.</p> <p>Evaluative results of FPC rigidity and various items are available. Please inquire.</p> <p>0.3mm or more thickness for glass epoxy and 0.2mm or more for stainless is recommended for the stiffener.</p>

USA:

HIROSE ELECTRIC (U.S.A.), INC. Headquarters

2688 Westhills Court, Simi Valley, CA 93065-6235
Phone : +1-805-522-7958
Fax : +1-805-522-3217
<http://www.hiroseusa.com>

USA:

HIROSE ELECTRIC (U.S.A.), INC. San Jose Office

20400 Stevens Creek Blvd., Ste 250, Cupertino,
CA 95014
Phone : +1-408-253-9640
Fax : +1-408-253-9641
<http://www.hiroseusa.com>

USA:

HIROSE ELECTRIC (U.S.A.), INC. Detroit Office (Automotive)

37677 Professional Center Drive, Suite #100C
Livonia, MI 48154
Phone : +1-734-542-9963
Fax : +1-734-542-9964
<http://www.hiroseusa.com>

THE NETHERLANDS:

HIROSE ELECTRIC EUROPE B.V.

Hogehillweg #8 1101 CC Amsterdam Z-0
Phone : +31-20-6557460
Fax : +31-20-6557469
<http://www.hiroseeurope.com>

GERMANY:

HIROSE ELECTRIC EUROPE B.V. GERMAN BRANCH

Herzog-Carl-Strasse 4 D-73760 Ostfildern
(Scharnhauser Park)
Phone : +49-711-4560-02-1
Fax : +49-711-4560-02-299
<http://www.hirose.de>

UNITED KINGDOM:

HIROSE ELECTRIC EUROPE B.V. UK BRANCH

First Floor, St Andrews House, Caldecotte Lake
Business Park, Milton Keynes MK7 8LE
Phone : +44-1908-369060
Fax : +44-1908-369078
<http://www.hirose.co.uk>

CHINA:

HIROSE ELECTRIC (SHANGHAI) CO., LTD.

1601, Henderson Metropolitan, NO.300, East Nanjing
Road, Huangpu District, Shanghai, China 200001
Phone : +86-21-6391-3355
Fax : +86-21-6391-3335
<http://www.hirose-china.com.cn>

CHINA:

HIROSE ELECTRIC (SHANGHAI) CO., LTD. BEIJING BRANCH

A1001, Ocean International Center, Building 56# East 4th
Ring Middle Road, Chao Yang District, Beijing, 100025
Phone : +86-10-5165-9332
Fax : +86-10-5908-1381
<http://www.hirose-china.com.cn>

CHINA:

HIROSE ELECTRIC TECHNOLOGIES (SHENZHEN) CO., LTD.

Room 09-13, 19/F, Office Tower Shun Hing Square, Di Wang Commercial Centre
5002, ShenNanDong Road, ShenZhen City, Guangdong Province, 518008
Phone : +86-755-8207-0851
Fax : +86-755-8207-0873
<http://www.hirose-china.com.cn>

HONG KONG:

HIROSE ELECTRIC HONGKONG TRADING CO., LTD.

Room 1001, West Wing, Tsim Sha Tsui Centre, 66
Mody Road, Tsim Sha Tsui East, Kowloon, Hong Kong
Phone : +852-2803-5338
Fax : +852-2591-6560
<http://www.hirose-hongkong.com.hk>

TAIWAN:

HIROSE ELECTRIC TAIWAN CO., LTD.

103 8F, No.87, Zhengzhou Rd., Taipei
Phone : +886-2-2555-7377
Fax : +886-2-2555-7350
<http://www.hirose-taiwan.com.tw>

KOREA:

HIROSE KOREA CO., LTD.

1261-10, Jeoungwhang-Dong, Shihung-City,
Kyunggi-Do 429-450
Phone : +82-31-496-7000, 7124
Fax : +82-31-496-7100
<http://www.hirose.co.kr>

SINGAPORE:

HIROSE ELECTRIC SINGAPORE PTE. LTD.

10 Anson Road #26-16 International Plaza 079903
Phone : +65-6324-6113
Fax : +65-6324-6123
<http://www.hirose-singapore.com.sg>

INDIA:

HIROSE ELECTRIC SINGAPORE PTE. LTD. BANGALORE LIAISON OFFICE

Unit No.03, Ground Floor, Explorer Building International Tech
Park Whitefield Road, Bangalore 560066 Karnataka, India
Phone : +65-6324-6113
Fax : +65-6324-6123
<http://www.hirose-singapore.com.sg>



HIROSE ELECTRIC CO.,LTD.

6-3, Nakagawa Chuoh-2-Chome, Tsuzuki-Ku, Yokohama-Shi 224-8540, JAPAN
TEL: +81-45-620-3526 Fax: +81-45-591-3726
<http://www.hirose.com>
<http://www.hirose-connectors.com>
