

CPS4018



◆ 特征 Feature

- 4.0 × 4.0mm 小尺寸封装，不高于 1.8 mm。
4.0 × 4.0 mm footprint; less than 1.8 mm tall.
- 直流电阻小及极好的定格电流特性。
Low DCR and excellent current handling.
- 适用于回流焊 SMT 工艺。
Suitable for reflow soldering.

◆ 外形尺寸 Dimension

型号 Part number	电感量 Inductance	直流电阻 DCR	自谐频率 SRF	饱和电流 Isat	温升电流 I _{rms}
Units	(μH)	(Ω) max	(MHz) typ	(A) 30% drop	(A) 40°C rise
CPS4018-R56ML_	0.56±20%	0.033	250	5.3	2.8
CPS4018-1R0ML_	1.0±20%	0.042	180	4.0	2.5
CPS4018-2R2ML_	2.2±20%	0.070	90	2.9	2.0
CPS4018-3R3ML_	3.3±20%	0.080	75	2.0	1.9
CPS4018-4R7ML_	4.7±20%	0.125	65	1.9	1.8
CPS4018-6R8ML_	6.8±20%	0.150	50	1.3	1.5
CPS4018-100ML_	10±20%	0.200	40	1.3	1.25
CPS4018-150ML_	12±20%	0.260	32	0.94	1.12
CPS4018-180ML_	15±20%	0.270	27	0.85	1.00
CPS4018-220ML_	18±20%	0.360	26	0.83	0.90
CPS4018-330ML_	22±20%	0.420	20	0.68	0.80
CPS4018-470ML_	33±20%	0.650	16	0.56	0.68
CPS4018-680ML_	39±20%	0.950	13	0.46	0.56
CPS4018-101ML_	47±20%	1.40	10	0.37	0.50
CPS4018-121ML_	56±20%	1.60	9.0	0.34	0.45
CPS4018-151ML_	68±20%	2.00	8.0	0.30	0.40
CPS4018-181ML_	82±20%	2.50	7.5	0.27	0.36
CPS4018-221ML_	100±20%	3.70	6.5	0.235	0.30
CPS4018-331ML_	220±20%	5.90	5.5	0.20	0.23
CPS4018-471ML_	470±20%	7.80	4.5	0.17	0.20
CPS4018-561ML_	560±20%	10.0	4.0	0.15	0.18
CPS4018-681ML_	680±20%	11.5	3.5	0.14	0.16
CPS4018-821ML_	820±20%	14.0	2.9	0.13	0.14
CPS4018-102ML_	1000±20%	18.0	2.8	0.11	0.125
CPS4018-152ML_	1500±20%	25.0	2.4	0.105	0.110
CPS4018-182ML_	1800±20%	31.5	2.3	0.100	0.195
CPS4018-222ML_	2200±20%	32.5	2.1	0.100	0.090
CPS4018-332ML_	3300±20%	48.0	1.6	0.094	0.075

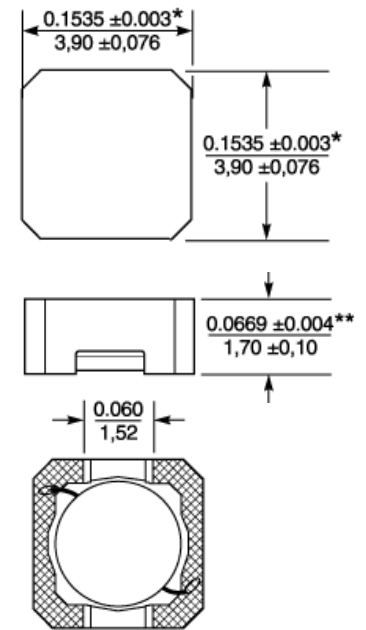

Recommended Land Pattern

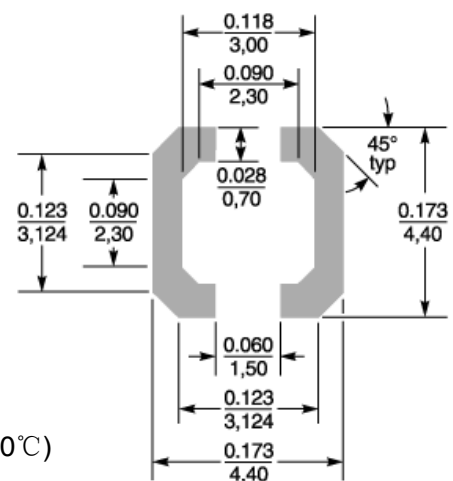

Dimensions are in $\frac{\text{inches}}{\text{mm}}$

※ 饱和电流：电感值下降到标准值的 70% 时的电流值。
 Isat: This indicates the value of DC current when the inductance decreases to 70% of its nominal value.

※ 温升电流：线圈温度上升 $\Delta T=40^\circ\text{C}$ 时的电流值（基准温度 $T_a=20^\circ\text{C}$ ）
 I_{rms}: The current when temperature of coil becomes $\Delta T=40^\circ\text{C}$. ($T_a=20^\circ\text{C}$)

continued on next page 接下页

continued from previous page 接上页 CPS4018

◆ 电感值 vs 电流曲线
Typical L vs Current

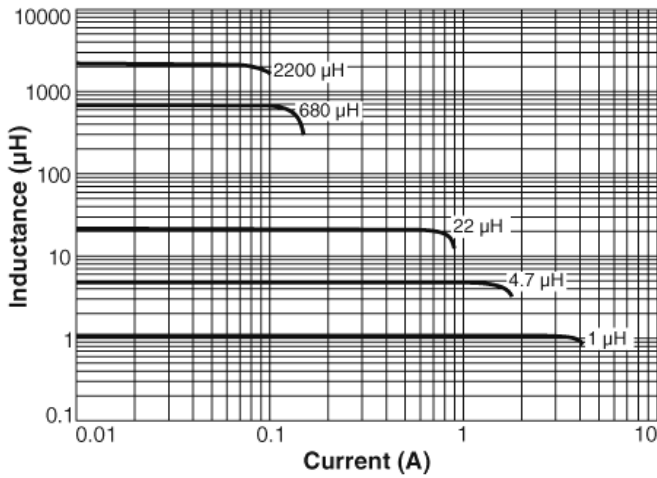

◆ 电感值 vs 频率曲线
Typical L vs Frequency

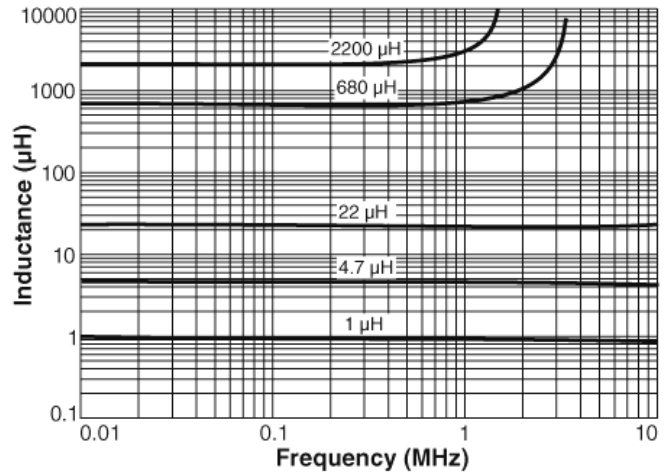

◆ 电流下降曲线
Irms Derating

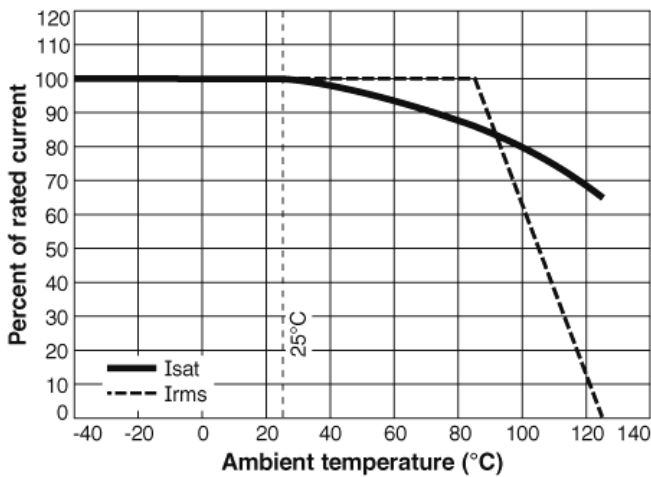

◆ 包装方式
Packaging

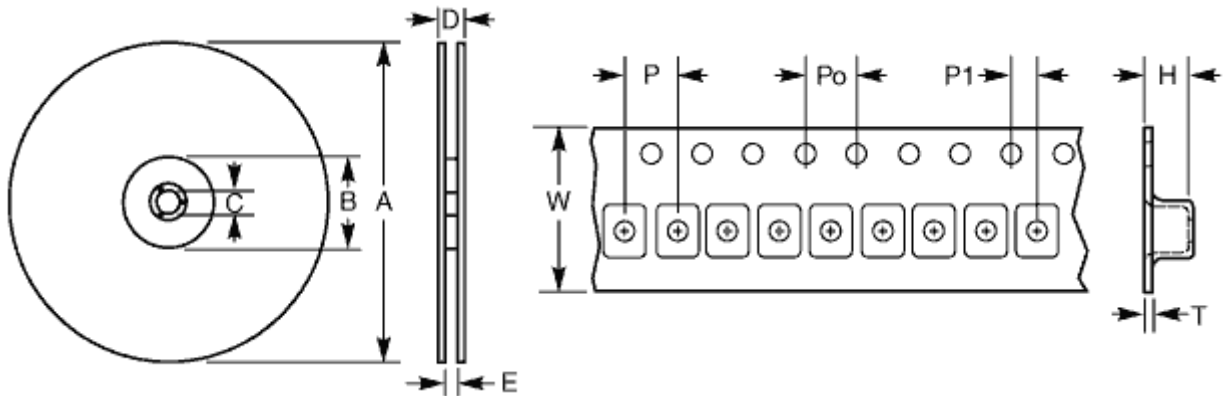

每盘数量 Parts per reel	卷盘尺寸 Reel dimensions (mm)					卷带尺寸 Tape dimensions (mm)						方向 Orientation
	A	B	C	D	E	W	P	Po	P1	H	T	
13" (330 mm)	330	100	13	18,4	12,4	12	8	4	2	1,9	0,23	
3500												