

### Features

- 1.3V maximum dropout at full load current
- Fixed 1.2V±2% output voltage
- Fast transient response
- Output current limiting
- Built-in thermal shutdown
- Good noise rejection
- Packages: SOT223-3L, TO252-3L, SOT89-3L
- SOT223-3L and TO252-3L: Available in "Green" Molding Compound (No Br, Sb) (Note 1)
- Lead Free Finish/RoHS Compliant (Note 2)

### General Description

AP1122 is a low dropout positive fixed-mode regulator with 1A output current capability. The product is specifically designed to provide well-regulated supply for low voltage IC applications such as high-speed bus termination and low current 1.2V logic supply. AP1122 is also well suited for other applications such as VGA cards. AP1122 is guaranteed to have lower than 1.3V dropout at full load current making it ideal to provide well-regulated outputs of 1.2 output voltage with 2.5V input voltage supply.



### Applications

- PC peripheral
- Communication

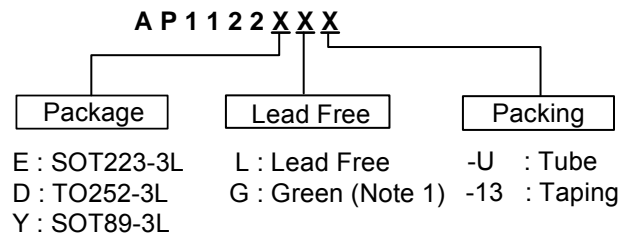
### Ordering Information



- Note: 1. Green is only for SOT223-3L and TO252-3L.  
 2. RoHS revision 13.2.2003. Glass and High Temperature Solder Exemptions Applied, see *EU Directive Annex Notes 5 and 7*.

Device (Note 3)	Package Code	Packaging (Note 3)	Tube/Bulk		13" Tape and Reel	
			Quantity	Part Number Suffix	Quantity	Part Number Suffix
 AP1122E	E	SOT223-3L	75	-U	2500/Tape & Reel	-13
 AP1122D	D	TO252-3L	80	-U	2500/Tape & Reel	-13
 AP1122Y	Y	SOT89-3L	NA	NA	2500/Tape & Reel	-13

- Note: 3. Pad layout as shown on Diodes Inc. suggested pad layout document AP02001, which can be found on our website at <http://www.diodes.com/datasheets/ap02001.pdf>.

**Pin Assignment**

(1) SOT223-3L

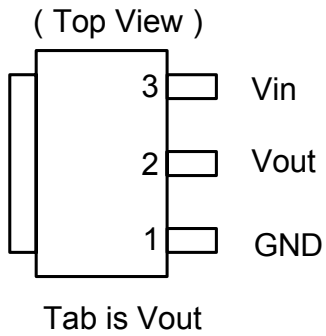

(2) TO252-3L

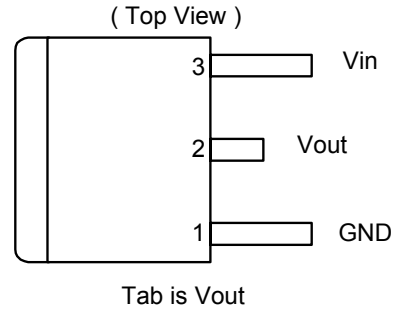

(3) SOT89-3L

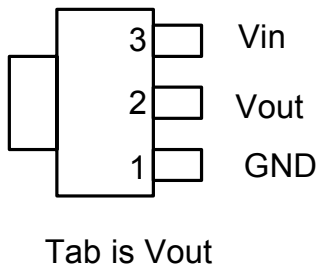

**Typical Application Circuit**

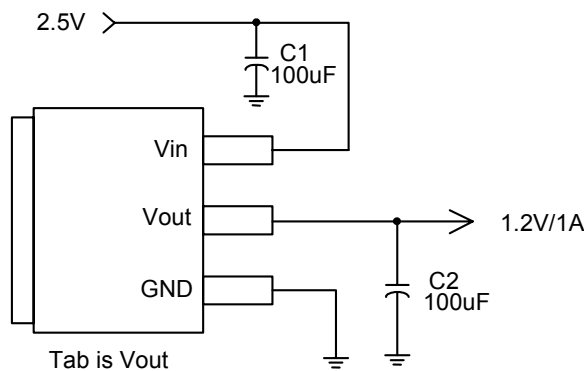

**Block Diagram**

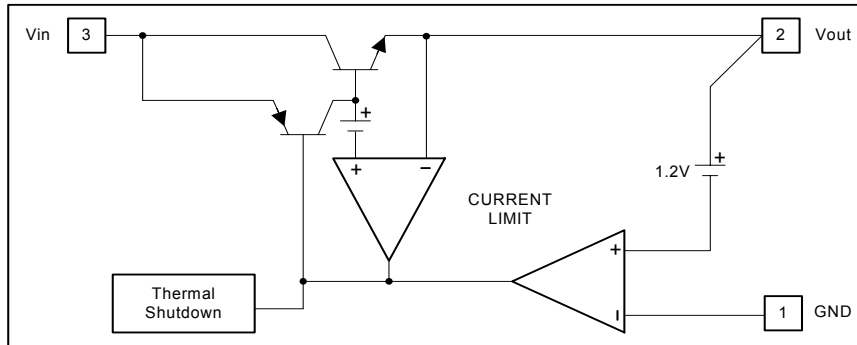

**Pin Descriptions**

NAME	I/O	PIN #	FUNCTION
GND	I	1	Ground Pin
Vout	O	2	The output of the regulator. A minimum of 10uF capacitor ( $0.15\Omega \leq ESR \leq 20\Omega$ ) must be connected from this pin to ground to insure stability.
Vin	I	3	The input pin of regulator. Typically a large storage capacitor ( $0.15\Omega \leq ESR \leq 20\Omega$ ) is connected from this pin to ground to insure that the input voltage does not sag below the minimum dropout voltage during the load transient response. This pin must always be 1.3V higher than Vout in order for the device to regulate properly.

**Absolute Maximum Ratings**

Symbol	Parameter	Rating	Unit
Vin	DC Supply Voltage	-0.3 to 12	V
T <sub>ST</sub>	Storage Temperature	-65 to +150	°C
T <sub>OP</sub>	Operating Junction Temperature Range	0 to +125	°C
T <sub>M</sub>	Maximum Junction Temperature	150	°C

### Electrical Characteristics (Under Operating Conditions)

PARAMETER	CONDITIONS	MIN	TYP	MAX	UNIT
Output Voltage	$2.5V \leq V_{IN} \leq 12V, T_A = 25^\circ C$	1.176	1.2	1.224	V
Line Regulation	$I_O = 10mA, 2.5V < V_{IN} < 12V, T_A = 25^\circ C$			0.2	%
Load Regulation	$V_{IN} = 2.5V \sim 12V, V_{adj} = 0, 0mA < I_O < 1A, T_A = 25^\circ C$ (Note 4,5)			1	%
Dropout Voltage ( $V_{IN} - V_{OUT}$ )	$I_{OUT} = 1A, \Delta V_{OUT} = 0.1\% V_{OUT}$		1.3	1.4	V
Current Limit	$(V_{IN} - V_{OUT}) = 5V$	1.1			A
Minimum Load Current (Note 6)	$0^\circ C \leq T_J \leq 125^\circ C$		5	10	mA
Thermal Regulation	$T_A = 25^\circ C, 30ms$ pulse		0.008	0.04	%/W
Ripple Rejection	$F = 120Hz, C_{OUT} = 25\mu F$ Tantalum, $I_{OUT} = 1A,$ $V_{IN} = V_{OUT} + 3V$		60	70	dB
Temperature Stability	$I_O = 10mA$		0.5		%
$\theta_{JA}$ Thermal Resistance Junction-to-Ambient	SOT89-3L : Control Circuitry/Power Transistor (Note 7) SOT223-3L : Control Circuitry/Power Transistor (Note 8) TO252-3L : Control Circuitry/Power Transistor (Note 9)		182 107 73		$^\circ C/W$
$\theta_{JC}$ Thermal Resistance Junction-to-Case	SOT89-3L : Control Circuitry/Power Transistor (Note 7) SOT223-3L : Control Circuitry/Power Transistor (Note 8) TO252-3L : Control Circuitry/Power Transistor (Note 9)		42 12 16		$^\circ C/W$

- Note:
- See thermal regulation specifications for changes in output voltage due to heating effects. Line and load regulation are measured at a constant junction temperature by low duty cycle pulse testing. Load regulation is measured at the output lead = 1/18" from the package.
  - Line and load regulation are guaranteed up to the maximum power dissipation of 15W. Power dissipation is determined by the difference between input and output differential and the output current. Guaranteed maximum power dissipation will not be available over the full input/output range.
  - Quiescent current is defined as the minimum output current required in maintaining regulation. At 12V input/output differential the device is guaranteed to regulate if the output current is greater than 10mA.
  - Test condition for SOT89-3L: no air flow, no heat sink.
  - Test condition for SOT223-3L:  $T_A = 27^\circ C$ , no air flow, device mounted on 2"X2" polyimide PCB, 2 oz copper, 5.6mmX5.6mm pad.
  - Test condition for TO252-3L:  $T_A = 27^\circ C$ , no air flow, device mounted on 2"X2" polyimide PCB, 1 oz copper, 2cmX2cm pad.

**Typical Performance Characteristics**

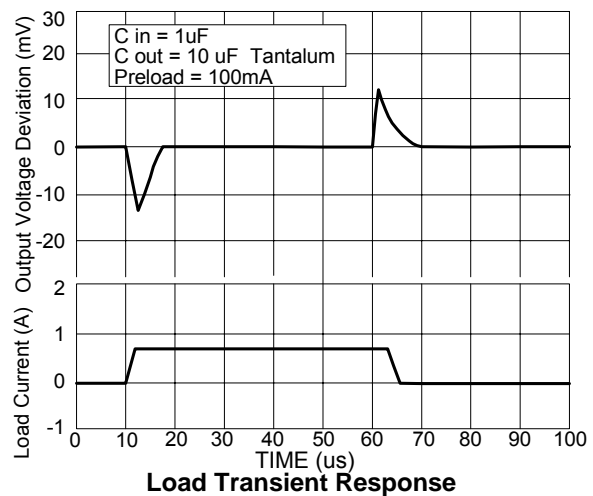
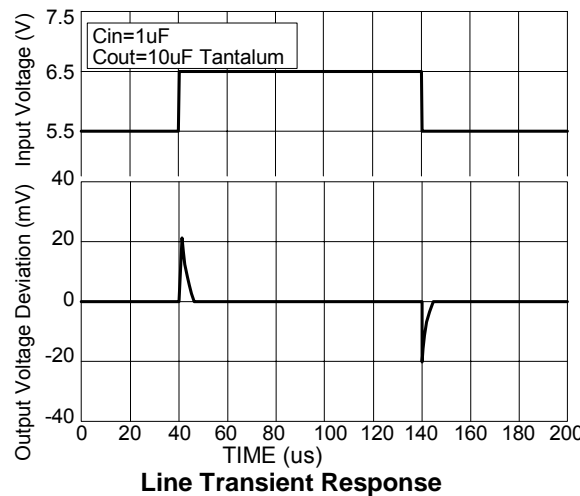
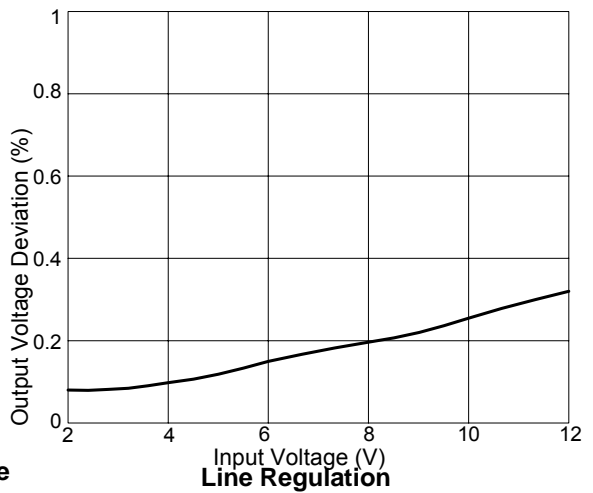
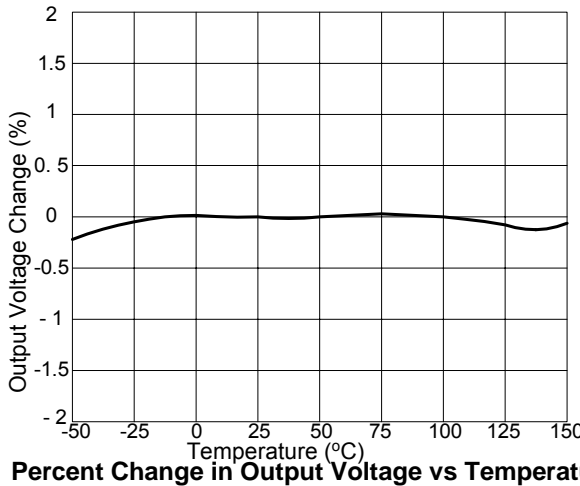
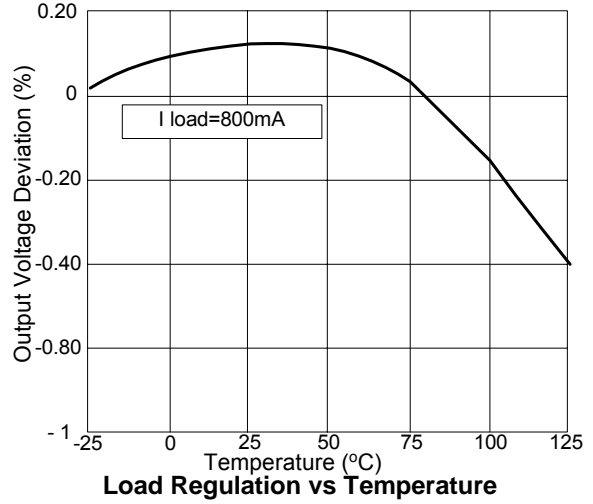
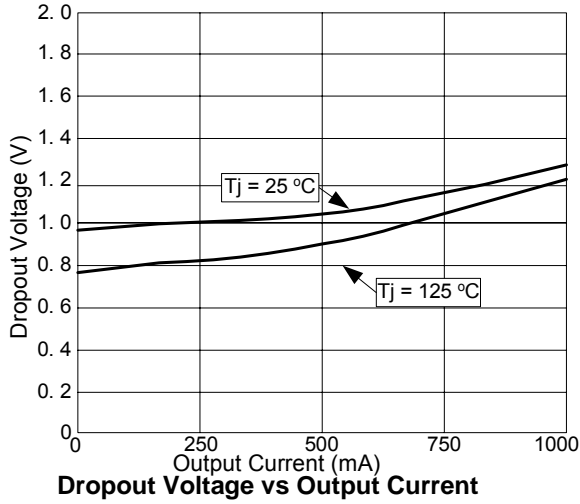

**Marking Information**

**(1) SOT223-3L**

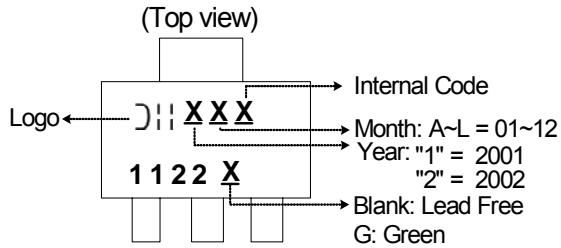

**(2) TO252-3L**

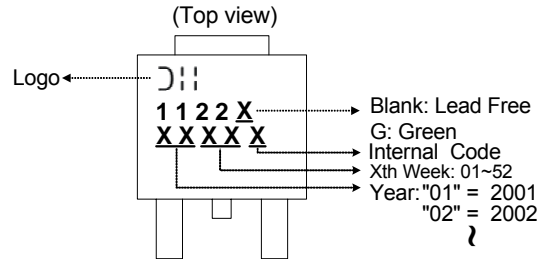

**(3) SOT89-3L**

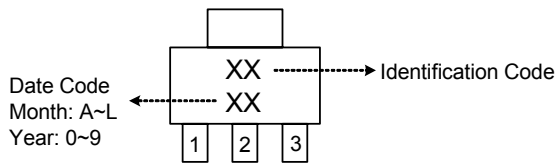

Identification code	Output version
JB	AP1122

**Package Information**

(1) SOT223-3L

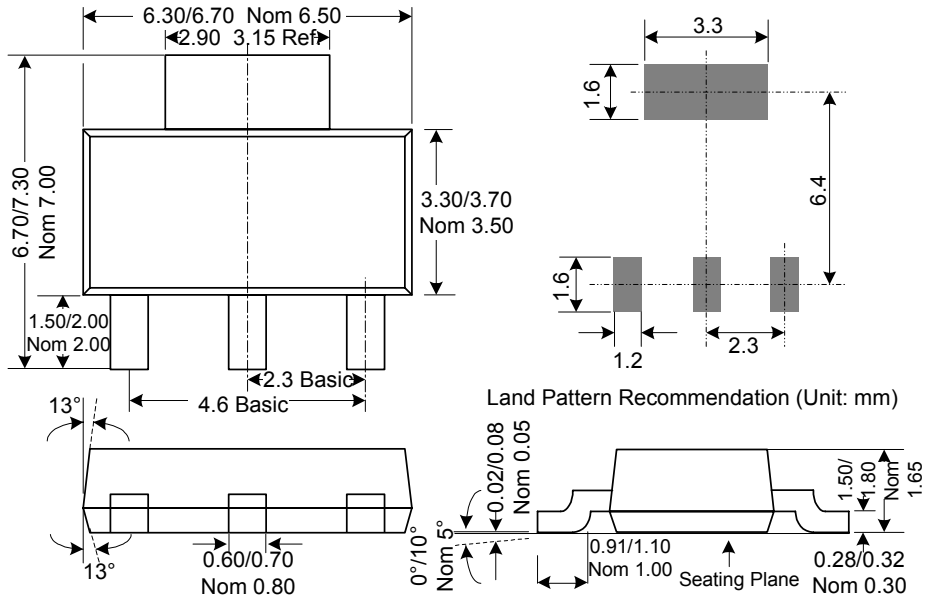

**Package Information (Continued)**

**(2) TO252-3L**

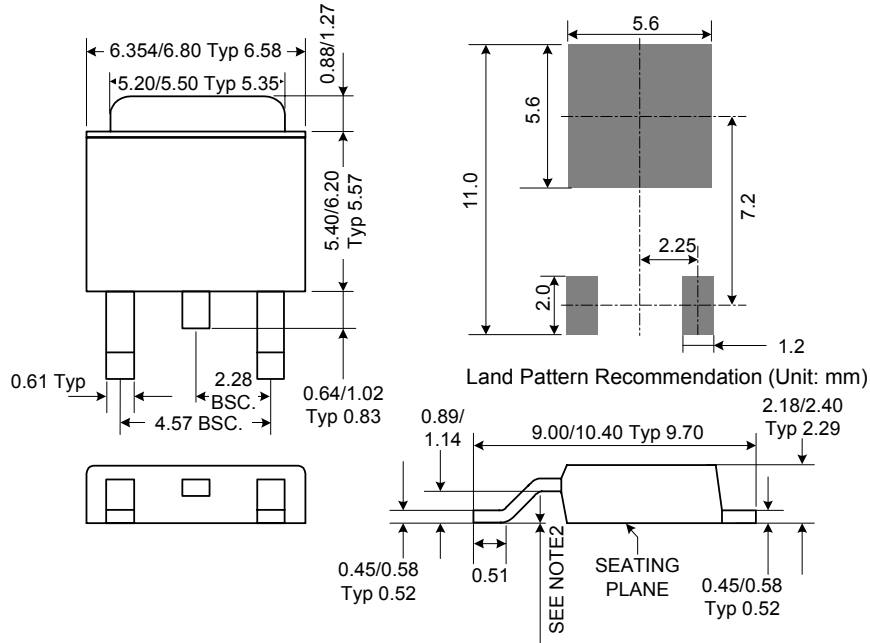

Note: 10. JEDEC Outline: TO-252 AB  
Mils suggested for positive contact at mounting.

**(3) SOT89-3L**

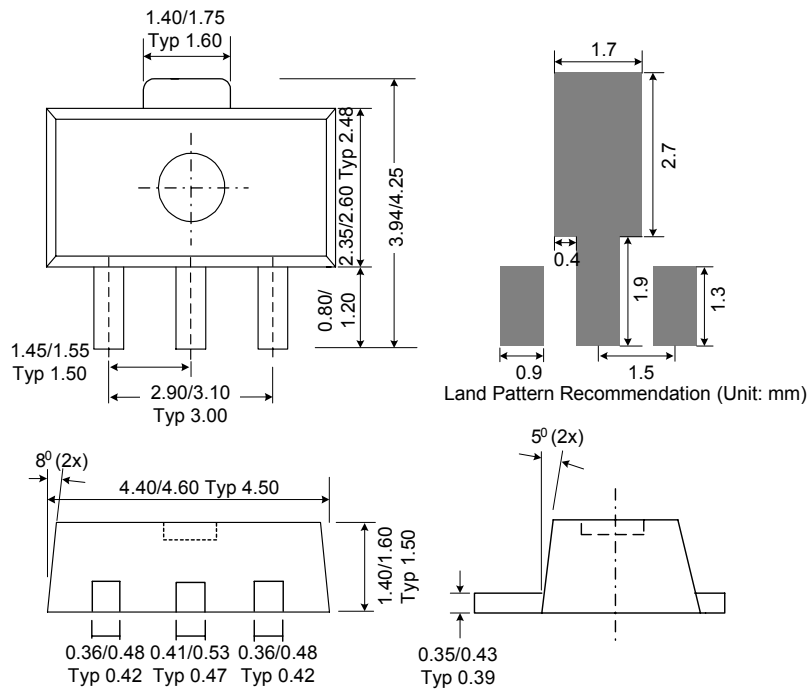



**IMPORTANT NOTICE**

Diodes Incorporated and its subsidiaries reserve the right to make modifications, enhancements, improvements, corrections or other changes without further notice to any product herein. Diodes Incorporated does not assume any liability arising out of the application or use of any product described herein; neither does it convey any license under its patent rights, nor the rights of others. The user of products in such applications shall assume all risks of such use and will agree to hold Diodes Incorporated and all the companies whose products are represented on our website, harmless against all damages.

**LIFE SUPPORT**

Diodes Incorporated products are not authorized for use as critical components in life support devices or systems without the expressed written approval of the President of Diodes Incorporated.