

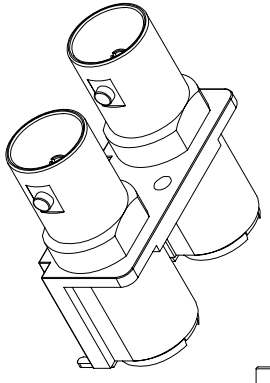

Product No.		DOSIN-801-0144		
REV	DESCRIPTION	DWN	DATE	APPROVEN
A	First Issue	JIM	2012/11/02	John kime

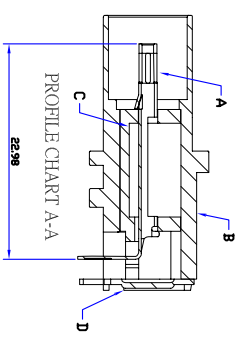
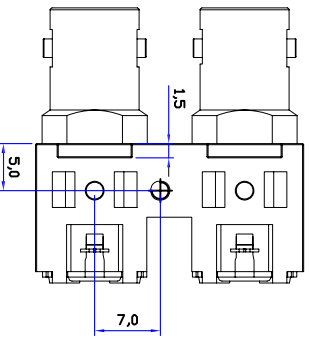
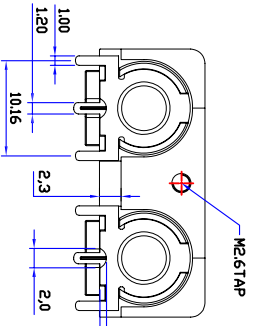
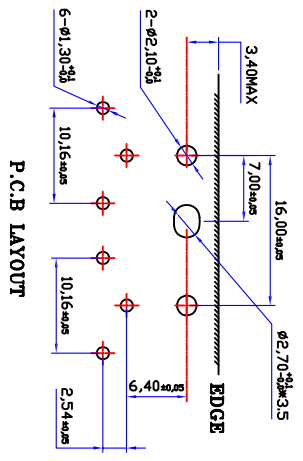
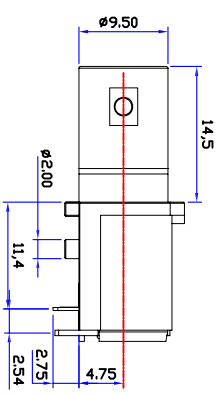
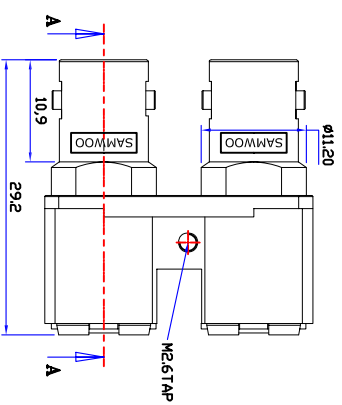
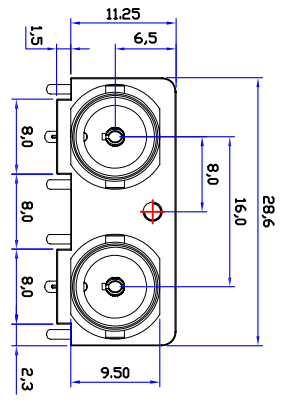
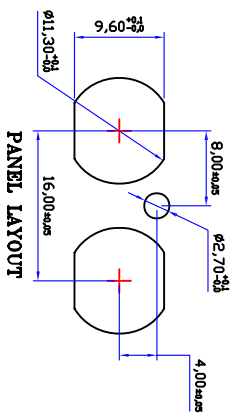

Specifications
 Impedance: 75 Ohms
 Frequency Range: DC~3G
 VSWR: 1.3MAX
 Working Voltage: 500V rms @ sea level
 Insulation Resistance: 5000 Ohms min
 Temperature Range: -55°C T0 +155°C
 Relative Temperature: ≤95% (40° C ±2° C)
 Drawings products are in line with ROHS standards

NOTE:
 Tolerance
 0-6 ±0.10
 6-30 ±0.20
 30-120 ±0.40
 Angular ±2°

Name: **BNC CONNECTOR**
 Dosin Industrial(H.K)Co.Ltd
 东莞市德奈五金电子有限公司
 Dosin Hardware Electronics Co.,Ltd
 E-mail: dosin2005@163.com
 dosin2005@dosing-china.com
 Web: http://www.dosing.com
 TEL: (0086)769-81153906
 FAX: (0086)769-81875836

3	BY-00001-NI-0	ZINC	NICKE	1
2	PN-00002-NI-0	Brass	GOLD	1
1	IN-00001-0	POM	White	1
NO	DESCRIPTION	MATERIAL	FINISH	QTY

DRAWN	Zelin Zhang	2012/11/10	View	UNIT	MM	SCALE	1:1
CHECKED							
APPROVALS	<i>John Kime</i>	19/04/2012					

SIZE	Product NO.	CAD FILE	SHEET: 1 OF 1
A	DOSIN-801-0144	D/company drawings/BD	