

## Passive components sales offices

### • Head office

206, Cheomdansaneop Road,  
Yeongtong-gu, Suwon-city,  
Gyeonggi province, Korea,  
443-743

Europe  
Tel: +82-31-210-6328  
E-mail: james.pyun@samsung.com

America  
Tel: +82-31-210-6794  
E-mail: randy.kim@samsung.com

Asia  
Tel: +82-31-210-5348  
E-mail: koogi@samsung.com

Domestic  
Tel: +82-31-210-3757  
E-mail: southjoy@samsung.com

### • Manufacturing sites

Suwon Plant (Korea)  
206, Cheomdansaneop Road,  
Yeongtong-gu, Suwon-city,  
Gyeonggi province, Korea,  
443-743  
Tel: +82-31-210-6794  
E-mail: randy.kim@samsung.com

Busan Plant (Korea)  
1623-2, Songjeong-dong,  
Gangseo-gu, Busan, Korea,  
618-270  
Tel: +82-51-970-7671  
E-mail: kyc.kweon@samsung.com

Tianjin Plant (China)  
27, Heiniucheng-Road, Hexi District,  
Tianjin, 300210 China  
Tel: +86-22-2397-9000(310)  
E-mail: moohantop.Park@samsung.com

Philippines Plant (Philippines)  
Block No.5, Calamba Premiere  
International Park, Batino, Calamba,  
Laguna, Manila, Philippines 4027  
Tel: +63-49-545-0422  
E-mail: donna@samsung.com

### • Asia sales offices

Shenzhen Office  
46 F, New World Center,  
Yitian Road, Futian District,  
Shenzhen, 518026 China  
Tel: 86-755-8608-5571  
E-mail: jackson.xian@samsung.com

Shanghai Office  
Rm. 1211, Shanghai International  
Trade Center, No. 2201 Yan an(W) Rd.,  
Shanghai, 200335 China  
Tel: 86-21-6270-4168(274)  
E-mail: dennis.cha@samsung.com

HongKong Office  
8/F., Central Plaza, 18 Harbour Road,  
Wanchai, Hongkong, China  
Tel: 86-755-8608-5570  
E-mail: hary7.hwang@samsung.com

Qingdao Office  
Rm 1201, Growne Plaza Qingdao 76,  
Xiang Gang Zhong Rd, Qingdao,  
266071 China  
Tel: 86-532-8577-9102  
E-mail: zhengguo.cui@samsung.com

Taiwan Office  
9F-1, Np. 399 Ruey Kuang Rd., Neihu  
District, Taipei City, Taiwan, 114  
Tel: 886-2-2656-8356  
E-mail: kevin0130.wang@samsung.com

Singapore Office  
3 Church Street Samsung Hub,  
#23-02 Singapore 049483  
Tel: 65-6833-3228  
E-mail: winson.yeong@samsung.com

Bangkok Office  
23rd Floor, Lake Rajada Office Complex  
193/89 Rachadapisek Road,  
Khet Klongtoey, Bangkok 10110, Thailand  
Tel: 66-2-661-8004~5  
E-mail: yangshin.yi@samsung.com

### • America sales office

Irvine Office  
3345 Michelson Drive,  
Suite 350, Irvine, CA 92612, USA  
Tel: 1-949-797-8047  
E-mail: sh386.kim@samsung.com

### • Europe sales offices

Frankfurt Office  
Samsung Haus, Am Kronberger Hang 6,  
D-65824 Schwalbach/Ts. Germany  
Tel: 49-6196-66-7255  
E-mail: frank.goebel@samsung.com

Hungary Office  
H-2310, Leshegy utca 2-4,  
Szigetszentmiklos, Pest megye, Hungary  
Tel: 36-24-551-148  
E-mail: jun21c.lee@samsung.com

### • Domestic Distributors

Korchip Corporation  
817-38, Anyang 2-dong, Manan-gu,  
Anyang-city, Gyeonggi province,  
Korea, 430-812  
Tel: +82-31-361-8100  
E-mail: itasap@korchip.com

Chunghan  
Chunghan Bldg., 121-284, Dangsan-dong,  
Youngdeungpo-gu, Seoul, Korea  
Tel: +82-2-718-3322  
E-mail: ish@ichunghan.co.kr

SAMT  
Daekyung Bldg., 983-10, Daechi-dong,  
Gangnam-gu, Seoul, Korea  
Tel: +82-2-3458-9000  
E-mail: info@isamt.com

CHUNGMAC  
#53-5 Wonhyoro-3ga Yongsan-gu,  
Seoul, Korea  
Tel: +82-31-234-2367~8  
E-mail: webmaster@chungmac.co.kr

APEXINT  
Room #905, C-dong Woorimlion's Valley  
371-28, Gasan-dong, Guemcheon-gu,  
Seoul, Korea  
Tel: +82-2-2026-2610(2)  
E-mail: info@apexint.co.kr

August 2010



# MULTILAYER CERAMIC CAPACITORS

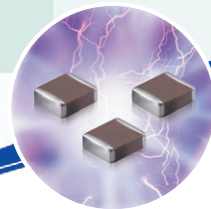

SAMSUNG  
ELECTRO-MECHANICS





## We, Samsung, declare that our component MLCC is produced in accordance with EU RoHS directive.

### 1. RoHS Compliance and restriction of Br

The following restricted materials are not used in packaging materials as well as products in compliance with the law and restriction.

- Cd, Pb, Hg, Cr+6, As, Br and the compounds, PCB, asbestos
- Bromic materials : PBBs, PBBOs, PBDO, PBDE, PBB

### 2. No use of materials breaking Ozone layer

The following ODS materials are not used in our fabrication process.

- ODS material : Freon, Haron, 1-1-1 TCE, CCl4, HCFC

If you want more detailed Information, Please Visit Samsung Electro-mechanics Website <http://www.sem.samsung.com>

Please, see the last page of this catalog for our environmental certification list.

## CONTENTS

Part Numbering System .....	4	Part Numbering System
General Capacitors .....	6	General Capacitors
High Capacitance Capacitors .....	23	High Capacitance Capacitors
Super Small Size Capacitors .....	37	Super Small Size Capacitors
Medium-High Voltage Capacitors .....	41	Medium-High Voltage Capacitors
Array Type Capacitors .....	52	Array Type Capacitors
Low ESL Capacitors .....	55	Low ESL Capacitors
Reliability Test Condition .....	58	Reliability Test Condition
Premium Capacitors for Automotive Applications .....	62	Premium Capacitors for Automotive Applications
Packaging Specification .....	78	Packaging Specification
Application Manual for Surface Mounting .....	82	Application Manual for Surface Mounting



**Class I (Temperature Compensation)**

Symbol	EIA Code	Operation Temperature Range(°C)	Temperature Coefficient Range(ppm/°C)
C	COG	-55 ~ +125	0 ±30

**\* Class II (High Dielectric Constant)**

Symbol	EIA Code	Operation Temperature Range(°C)	Capacitance Change(ΔC %)
A	X5R	-55 ~ + 85	±15
B	X7R	-55 ~ +125	±15
X	X6S	-55 ~ +105	±22
F	Y5V	-30 ~ + 85	-82 ~ +22
Y	X7S	-55 ~ +125	±22

**\*\***

Series	TC	Capacitance Step																	
		1.0			1.5			2.2			3.3								
E-3	Y5V	1.0			2.2			4.7											
E-6	X5R X7R X6S	1.0			1.5			2.2			3.3			4.7			6.8		
E-12	COG	1.0	1.2	1.5	1.8	2.2	2.7	3.3	3.9	4.7	5.6	6.8	8.2						

**\*\*\***

Size	Code	Thickness(mm)	Spec(mm)	Size	Code	Thickness(mm)	Spec(mm)
01005(0402)	2	0.20	±0.02	1210(3225)	H	1.60	±0.20
0201(0603)	3	0.30	±0.03		U	1.80	±0.20
0402(1005)	5	0.50	±0.05		I	2.00	±0.20
0603(1608)	5	0.50	+0.0/-0.1		J	2.50	±0.20
	8	0.80	±0.10		V	2.50	±0.30
0805(2012)	A	0.65	±0.10	1808(4520)	F	1.25	±0.20
	C	0.85	±0.10		H	1.60	±0.20
	D	1.00	±0.15		I	2.00	±0.20
	F	1.25	±0.10	1812(4532)	F	1.25	±0.20
	Q	1.25	±0.15		H	1.60	±0.20
1206(3216)	Y	1.25	±0.2	I	2.00	±0.20	
	C	0.85	±0.15 *±0.10	J	2.50	±0.20	
	D	1.00	±0.15	L	3.20	±0.30	
	E	1.10	±0.10	2220(5750)	F	1.25	±0.20
	P	1.15	±0.10		H	1.60	±0.20
	F	1.25	±0.15		I	2.00	±0.20
H	1.60	±0.20	J		2.50	±0.20	
1210(3225)	C	0.85	±0.15 *±0.10	L	3.20	±0.30	
	9	0.90	±0.10				
	M	1.15	±0.10				
	F	1.25	±0.20				
	S	1.35	±0.15				

- \* Mark is only applicable to "L" code , 12<sup>th</sup> code in part number.
- Please discuss with sales person with regard to Pd products.

Part Numbering System

General Capacitors

High Capacitance Capacitors

Super Small Size Capacitors

Medium-High Voltage Capacitors

Array Type Capacitors

Low ESL Capacitors

Reliability Test Condition

Premium Capacitors for Automotive Applications

Packaging Specification

Application Manual for Surface Mounting

# General Capacitors

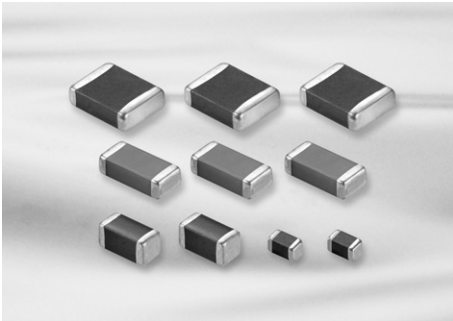

## Feature

- Wide selection of size : from 0402 to 2220
- Highly reliable tolerance and high speed automatic chip placement on PCBs
- Wide capacitance range
- Wide temperature compensation and voltage range : from COG to Y5V and from 6.3V to 50V
- Highly reliable performance
- Highly resistant termination metal
- Tape & reel for surface mount assembly

## Application

- HHP, DSC, DVC, LCD, TV, Car Navigation, Memory Module, PDA, Game Machine
- Tuner (Product code C is suitable.)
- ※ Medical, Aviation, Automobile device should be following a special specification.

## Structure and Dimensions

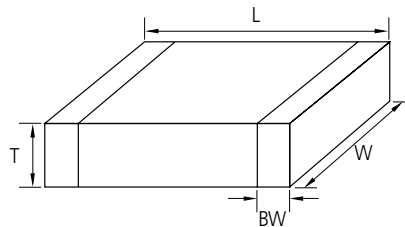

Size Code	EIA Code	Dimension(mm)				
		L	W	T	Thickness Code	BW
05	0402	1.00±0.05	0.50±0.05	0.50±0.05	5	0.2+0.15/-0.1
10	0603	1.60±0.10	0.80±0.10	0.50+0.0/-0.1	5	0.30±0.20
				0.80±0.10	8	
21	0805	2.00±0.10	1.25±0.10	0.85±0.10	C	0.5+0.2/-0.3
				1.25±0.10	F	
				1.25±0.15	Q	
31	1206	3.20±0.20	1.60±0.20	1.25±0.20	Y	0.50±0.30
				0.60±0.10	6	
				0.85±0.15	C	
32	1210	3.20±0.30	2.50±0.20	0.85±0.10(+)	P	0.60±0.30
				1.15±0.10		
				1.25±0.15	F	
				1.60±0.20	H	
				1.60±0.20	H	
42	1808	4.50±0.40	2.00±0.20	1.60±0.20	H	0.80±0.30
				1.80±0.20	U	
				2.00±0.20	I	
				2.50±0.20	J	
				2.50±0.30	v	
43	1812	4.50±0.40	3.20±0.30	3.20±0.30	L	0.80±0.30
55	2220	5.70±0.40	5.00±0.40	3.20±0.30	L	1.00±0.30

■ \* Mark is only applicable to "L" code , 12<sup>th</sup> code in part number.

### General Capacitors Table (COG)

Size(mm)	Vr(V)	Capacitance																					
		pF										nF											
		0.5	1	10	22	47	100	220	330	470	560	1	2.2	3.3	4.7	6.8	10	22	27	33	47	68	100
0402(1005)	25	[Capacitance values represented by shaded bars]																					
	50	[Capacitance values represented by shaded bars]																					
0603(1608)	25	[Capacitance values represented by shaded bars]																					
	50	[Capacitance values represented by shaded bars]																					
0805(2012)	25	[Capacitance values represented by shaded bars]																					
	50	[Capacitance values represented by shaded bars]																					
1206(3216)	16	[Capacitance values represented by shaded bars]																					
	25	[Capacitance values represented by shaded bars]																					
	50	[Capacitance values represented by shaded bars]																					
1210(3225)	50	[Capacitance values represented by shaded bars]																					
1812(4532)	25	[Capacitance values represented by shaded bars]																					
	50	[Capacitance values represented by shaded bars]																					
2220(5750)	50	[Capacitance values represented by shaded bars]																					

- Part Numbering System
- General Capacitors
- High Capacitance Capacitors
- Super Small Size Capacitors
- Medium-High Voltage Capacitors
- Array Type Capacitors
- Low ESL Capacitors
- Reliability Test Condition
- Premium Capacitors for Automotive Applications
- Packaging Specification
- Application Manual for Surface Mounting





**General Capacitors Table\_Low Profile (X5R)**

Size(mm)	Tmax (mm)	Vr(V)	Capacitance (uF)						
			1	2.2	4.7	10	22	33	47
0402(1005)	0.3	6.3	X6S						
		10							
		16							
0603(1608)	0.5	6.3							
		10							
		16							
		25							
0805(2012)	0.5	10							
		16							
		25							
	0.95	4						(Tmax=1.0)	
		6.3						(Tmax=1.0)	
10									
16									
25					X6S				
1206(3216)	0.7	10							
	0.95	6.3							
		10							
		16							
		25			X6S				
		50		(Tmax=1.0)					
1210(3225)	0.95	16							
	2.0	25							
		35							
		50							

- Part Numbering System
- General Capacitors
- High Capacitance Capacitors
- Super Small Size Capacitors
- Medium-High Voltage Capacitors
- Array Type Capacitors
- Low ESL Capacitors
- Reliability Test Condition
- Premium Capacitors for Automotive Applications
- Packaging Specification
- Application Manual for Surface Mounting



## General Capacitors Table (X7R)

Size(mm)	Vr(V)	Capacitance (uF)									
		0.1	0.22	0.47	1	2.2	4.7	10	22	47	100
0402(1005)	6.3	0.1	0.22	0.47	1	2.2	4.7	10	22	47	100
	10	0.1	0.22	0.47	1	2.2	4.7	10	22	47	100
	16	0.1	0.22	0.47	1	2.2	4.7	10	22	47	100
0603(1608)	6.3	0.1	0.22	0.47	1	2.2	4.7	10	22	47	100
	10	0.1	0.22	0.47	1	2.2	4.7	10	22	47	100
	16	0.1	0.22	0.47	1	2.2	4.7	10	22	47	100
	25	0.1	0.22	0.47	1	2.2	4.7	10	22	47	100
	50	0.1	0.22	0.47	1	2.2	4.7	10	22	47	100
0805(2012)	6.3	0.1	0.22	0.47	1	2.2	4.7	10	22	47	100
	10	0.1	0.22	0.47	1	2.2	4.7	10	22	47	100
	16	0.1	0.22	0.47	1	2.2	4.7	10	22	47	100
	25	0.1	0.22	0.47	1	2.2	4.7	10	22	47	100
	35	0.1	0.22	0.47	1	2.2	4.7	10	22	47	100
	50	0.1	0.22	0.47	1	2.2	4.7	10	22	47	100
1206(3216)	6.3	0.1	0.22	0.47	1	2.2	4.7	10	22	47	100
	10	0.1	0.22	0.47	1	2.2	4.7	10	22	47	100
	16	0.1	0.22	0.47	1	2.2	4.7	10	22	47	100
	25	0.1	0.22	0.47	1	2.2	4.7	10	22	47	100
	35	0.1	0.22	0.47	1	2.2	4.7	10	22	47	100
	50	0.1	0.22	0.47	1	2.2	4.7	10	22	47	100
1210(3225)	6.3	0.1	0.22	0.47	1	2.2	4.7	10	22	47	100
	10	0.1	0.22	0.47	1	2.2	4.7	10	22	47	100
	16	0.1	0.22	0.47	1	2.2	4.7	10	22	47	100
	25	0.1	0.22	0.47	1	2.2	4.7	10	22	47	100
	50	0.1	0.22	0.47	1	2.2	4.7	10	22	47	100

- Part Numbering System
- General Capacitors
- High Capacitance Capacitors
- Super Small Size Capacitors
- Medium-High Voltage Capacitors
- Array Type Capacitors
- Low ESL Capacitors
- Reliability Test Condition
- Premium Capacitors for Automotive Applications
- Packaging Specification
- Application Manual for Surface Mounting



**Product Lineup (General Capacitors-C0G)**

	Part Number	Size L×W (mm)	Capacitance	Rated Voltage (Vdc)	Capacitance Tolerance	Thickness Max. (mm)
1	CL05C0R5CB5NNN □	1.00×0.50	0.5pF	50	±0.25pF	0.55
2	CL05CR75CB5NNN □		0.75pF	50	±0.25pF	0.55
3	CL05C010CB5NNN □		1.0pF	50	±0.25pF	0.55
4	CL05C1R2CB5NNN □		1.2pF	50	±0.25pF	0.55
5	CL05C1R5CB5NNN □		1.5pF	50	±0.25pF	0.55
6	CL05C1R8CB5NNN □		1.8pF	50	±0.25pF	0.55
7	CL05C020CB5NNN □		2.0pF	50	±0.25pF	0.55
8	CL05C2R2CB5NNN □		2.2pF	50	±0.25pF	0.55
9	CL05C2R4CB5NNN □		2.4pF	50	±0.25pF	0.55
10	CL05C2R5CB5NNN □		2.5pF	50	±0.25pF	0.55
11	CL05C2R7CB5NNN □		2.7pF	50	±0.25pF	0.55
12	CL05C030CB5NNN □		3.0pF	50	±0.25pF	0.55
13	CL05C3R3CB5NNN □		3.3pF	50	±0.25pF	0.55
14	CL05C3R5CB5NNN □		3.5pF	50	±0.25pF	0.55
15	CL05C3R6CB5NNN □		3.6pF	50	±0.25pF	0.55
16	CL05C3R9CB5NNN □		3.9pF	50	±0.25pF	0.55
17	CL05C040CB5NNN □		4.0pF	50	±0.25pF	0.55
18	CL05C4R3CB5NNN □		4.3pF	50	±0.25pF	0.55
19	CL05C4R7CB5NNN □		4.7pF	50	±0.25pF	0.55
20	CL05C050DB5NNN □		5.0pF	50	±0.5pF	0.55
21	CL05C5R6DB5NNN □		5.6pF	50	±0.5pF	0.55
22	CL05C060DB5NNN □		6.0pF	50	±0.5pF	0.55
23	CL05C6R2DB5NNN □		6.2pF	50	±0.5pF	0.55
24	CL05C6R8DB5NNN □		6.8pF	50	±0.5pF	0.55
25	CL05C070DB5NNN □		7.0pF	50	±0.5pF	0.55
26	CL05C080DB5NNN □		8.0pF	50	±0.5pF	0.55
27	CL05C8R2DB5NNN □		8.2pF	50	±0.5pF	0.55
28	CL05C090DB5NNN □		9.0pF	50	±0.5pF	0.55
29	CL05C9R1DB5NNN □		9.1pF	50	±0.5pF	0.55
30	CL05C100JB5NNN □		10pF	50	±5%	0.55
31	CL05C110JB5NNN □		11pF	50	±5%	0.55
32	CL05C120JB5NNN □		12pF	50	±5%	0.55
33	CL05C130JB5NNN □		13pF	50	±5%	0.55
34	CL05C150JB5NNN □		15pF	50	±5%	0.55
35	CL05C160JB5NNN □		16pF	50	±5%	0.55
36	CL05C180JB5NNN □		18pF	50	±5%	0.55
37	CL05C200JB5NNN □		20pF	50	±5%	0.55
38	CL05C220JA5NNN □		22pF	25	±5%	0.55
39	CL05C220JB5NNN □		22pF	50	±5%	0.55
40	CL05C240JB5NNN □		24pF	50	±5%	0.55
41	CL05C270JB5NNN □		27pF	50	±5%	0.55
42	CL05C270JA5NNN □		27pF	25	±5%	0.55
43	CL05C300JB5NNN □		30pF	50	±5%	0.55
44	CL05C330JB5NNN □		33pF	50	±5%	0.55
45	CL05C360JB5NNN □		36pF	50	±5%	0.55
46	CL05C390JB5NNN □		39pF	50	±5%	0.55
47	CL05C430JB5NNN □		43pF	50	±5%	0.55
48	CL05C470JB5NNN □		47pF	50	±5%	0.55
49	CL05C510JB5NNN □		51pF	50	±5%	0.55
50	CL05C560JB5NNN □		56pF	50	±5%	0.55

※ □ mark means packaging code. If you want to learn the code or quantity in detail, please see p80.

- Part Numbering System
- General Capacitors
- High Capacitance Capacitors
- Super Small Size Capacitors
- Medium-High Voltage Capacitors
- Array Type Capacitors
- Low ESL Capacitors
- Reliability Test Condition
- Premium Capacitors for Automotive Applications
- Packaging Specification
- Application Manual for Surface Mounting



Product Lineup (General Capacitors-C0G)

	Part Number	Size L×W (mm)	Capacitance	Rated Voltage (Vdc)	Capacitance Tolerance	Thickness Max. (mm)
51	CL05C620JB5NNN □	1.00×0.50	62pF	50	±5%	0.55
52	CL05C680JB5NNN □		68pF	50	±5%	0.55
53	CL05C750JB5NNN □		75pF	50	±5%	0.55
54	CL05C820JB5NNN □		82pF	50	±5%	0.55
55	CL05C910JB5NNN □		91pF	50	±5%	0.55
56	CL05C101JB5NNN □		100pF	50	±5%	0.55
57	CL05C121JB5NNN □		120pF	50	±5%	0.55
58	CL05C151JB5NNN □		150pF	50	±5%	0.55
59	CL05C181JB5NNN □		180pF	50	±5%	0.55
60	CL05C201JB5NNN □		200pF	50	±5%	0.55
61	CL05C221JB5NNN □		220pF	50	±5%	0.55
62	CL05C271JB5NNN □		270pF	50	±5%	0.55
63	CL05C331JB5NNN □		330pF	50	±5%	0.55
64	CL05C391JB5NNN □		390pF	50	±5%	0.55
65	CL05C471JB5NNN □		470pF	50	±5%	0.55
66	CL05C471JO5NNN □		470pF	16	±5%	0.55
67	CL05C681JB5NNN □		680pF	50	±5%	0.55
68	CL05C821JB5NNN □		820pF	50	±5%	0.55
69	CL05C102JB5NNN □		1nF	50	±5%	0.55
70	CL05C102JA5NNN □		1nF	25	±5%	0.55
71	CL05C102JO5NNN □		1nF	16	±5%	0.55
1	CL10C0R3CB8NNN □	1.60×0.80	0.3pF	50	±0.25pF	0.90
2	CL10C0R5CB8NNN □		0.5pF	50	±0.25pF	0.90
3	CL10CR75CB8NNN □		0.75pF	50	±0.25pF	0.90
4	CL10C010CB8NNN □		1.0pF	50	±0.25pF	0.90
5	CL10C1R2CB8NNN □		1.2pF	50	±0.25pF	0.90
6	CL10C1R5CB8NNN □		1.5pF	50	±0.25pF	0.90
7	CL10C1R8CB8NNN □		1.8pF	50	±0.25pF	0.90
8	CL10C020CB8NNN □		2.0pF	50	±0.25pF	0.90
9	CL10C2R2CB8NNN □		2.2pF	50	±0.25pF	0.90
10	CL10C2R4CB8NNN □		2.4pF	50	±0.25pF	0.90
11	CL10C2R5CB8NNN □		2.5pF	50	±0.25pF	0.90
12	CL10C2R7CB8NNN □		2.7pF	50	±0.25pF	0.90
13	CL10C030CB8NNN □		3.0pF	50	±0.25pF	0.90
14	CL10C3R3CB8NNN □		3.3pF	50	±0.25pF	0.90
15	CL10C3R5CB8NNN □		3.5pF	50	±0.25pF	0.90
16	CL10C3R6CB8NNN □		3.6pF	50	±0.25pF	0.90
17	CL10C3R9CB8NNN □		3.9pF	50	±0.25pF	0.90
18	CL10C040CB8NNN □		4.0pF	50	±0.25pF	0.90
19	CL10C4R3CB8NNN □		4.3pF	50	±0.25pF	0.90
20	CL10C4R7CB8NNN □		4.7pF	50	±0.25pF	0.90
21	CL10C050DB8NNN □		5.0pF	50	±0.5pF	0.90
22	CL10C5R6DB8NNN □		5.6pF	50	±0.5pF	0.90
23	CL10C060DB8NNN □		6.0pF	50	±0.5pF	0.90
24	CL10C6R2DB8NNN □		6.2pF	50	±0.5pF	0.90
25	CL10C6R8DB8NNN □		6.8pF	50	±0.5pF	0.90
26	CL10C070DB8NNN □		7.0pF	50	±0.5pF	0.90
27	CL10C7R5DB8NNN □		7.5pF	50	±0.5pF	0.90
28	CL10C080DB8NNN □		8.0pF	50	±0.5pF	0.90
29	CL10C8R2DB8NNN □		8.2pF	50	±0.5pF	0.90

※ □ mark means packaging code. If you want to learn the code or quantity in detail, please see p80.

**Product Lineup (General Capacitors-C0G)**

	Part Number	Size L×W (mm)	Capacitance	Rated Voltage (Vdc)	Capacitance Tolerance	Thickness Max. (mm)
30	CL10C090DB8NNN □	1.60×0.80	9.0pF	50	±0.5pF	0.90
31	CL10C9R1DB8NNN □		9.1pF	50	±0.5pF	0.90
32	CL10C100JB8NNN □		10pF	50	±5%	0.90
33	CL10C110JB8NNN □		11pF	50	±5%	0.90
34	CL10C120JB8NNN □		12pF	50	±5%	0.90
35	CL10C130JB8NNN □		13pF	50	±5%	0.90
36	CL10C140JB8NNN □		14pF	50	±5%	0.90
37	CL10C150JB8NNN □		15pF	50	±5%	0.90
38	CL10C160JB8NNN □		16pF	50	±5%	0.90
39	CL10C180JB8NNN □		18pF	50	±5%	0.90
40	CL10C200JB8NNN □		20pF	50	±5%	0.90
41	CL10C220JB8NNN □		22pF	50	±5%	0.90
42	CL10C240JB8NNN □		24pF	50	±5%	0.90
43	CL10C250JB8NNN □		25pF	50	±5%	0.90
44	CL10C270JB8NNN □		27pF	50	±5%	0.90
45	CL10C300JB8NNN □		30pF	50	±5%	0.90
46	CL10C330JB8NNN □		33pF	50	±5%	0.90
47	CL10C360JB8NNN □		36pF	50	±5%	0.90
48	CL10C390JB8NNN □		39pF	50	±5%	0.90
49	CL10C430JB8NNN □		43pF	50	±5%	0.90
50	CL10C470JB8NNN □		47pF	50	±5%	0.90
51	CL10C510JB8NNN □		51pF	50	±5%	0.90
52	CL10C560JB8NNN □		56pF	50	±5%	0.90
53	CL10C620JB8NNN □		62pF	50	±5%	0.90
54	CL10C680JB8NNN □		68pF	50	±5%	0.90
55	CL10C750JB8NNN □		75pF	50	±5%	0.90
56	CL10C820JB8NNN □		82pF	50	±5%	0.90
57	CL10C910JB8NNN □		91pF	50	±5%	0.90
58	CL10C101JB8NNN □		100pF	50	±5%	0.90
59	CL10C111JB8NNN □	110pF	50	±5%	0.90	
60	CL10C121JB8NNN □	120pF	50	±5%	0.90	
61	CL10C131JB8NNN □	130pF	50	±5%	0.90	
62	CL10C151JB8NNN □	150pF	50	±5%	0.90	
63	CL10C161JB8NNN □	160pF	50	±5%	0.90	
64	CL10C181JB8NNN □	180pF	50	±5%	0.90	
65	CL10C201JB8NNN □	200pF	50	±5%	0.90	
66	CL10C221JB8NNN □	220pF	50	±5%	0.90	
67	CL10C241JB8NNN □	240pF	50	±5%	0.90	
68	CL10C271JB8NNN □	270pF	50	±5%	0.90	
69	CL10C301JB8NNN □	300pF	50	±5%	0.90	
70	CL10C331JB8NNN □	330pF	50	±5%	0.90	
71	CL10C361JB8NNN □	360pF	50	±5%	0.90	
72	CL10C391JB8NNN □	390pF	50	±5%	0.90	
73	CL10C431JB8NNN □	430pF	50	±5%	0.90	
74	CL10C471JB8NNN □	470pF	50	±5%	0.90	
75	CL10C511JB8NNN □	510pF	50	±5%	0.90	
76	CL10C561JB8NNN □	560pF	50	±5%	0.90	
77	CL10C621JB8NNN □	620pF	50	±5%	0.90	
78	CL10C681JB8NNN □	680pF	50	±5%	0.90	
79	CL10C751JB8NNN □	750pF	50	±5%	0.90	

Part Numbering System

General Capacitors

High Capacitance Capacitors

Super Small Size Capacitors

Medium-High Voltage Capacitors

Array Type Capacitors

Low ESL Capacitors

Reliability Test Condition

Premium Capacitors for Automotive Applications

Packaging Specification

Application Manual for Surface Mounting

※ □ mark means packaging code. If you want to learn the code or quantity in detail, please see p80.





Product Lineup (General Capacitors-C0G)

	Part Number	Size L×W (mm)	Capacitance	Rated Voltage (Vdc)	Capacitance Tolerance	Thickness Max. (mm)
80	CL10C821JB8NNN □	1.60×0.80	820pF	50	±5%	0.90
81	CL10C102JB8NNN □		1nF	50	±5%	0.90
82	CL10C182JB8NNN □		1.8nF	50	±5%	0.90
83	CL10C222JB8NNN □		2.2nF	50	±5%	0.90
84	CL10C562JB8NNN □		5.6nF	50	±5%	0.90
1	CL21C47CBANNN □	2.00×1.25	0.47pF	50	±0.25pF	0.75
2	CL21C0R5CBANNN □		0.5pF	50	±0.25pF	0.75
3	CL21C010CBANNN □		1.0pF	50	±0.25pF	0.75
4	CL21C1R2CBANNN □		1.2pF	50	±0.25pF	0.75
5	CL21C1R5CBANNN □		1.5pF	50	±0.25pF	0.75
6	CL21C1R8CBANNN □		1.8pF	50	±0.25pF	0.75
7	CL21C020CBANNN □		2.0pF	50	±0.25pF	0.75
8	CL21C2R2CBANNN □		2.2pF	50	±0.25pF	0.75
9	CL21C2R4CBANNN □		2.4pF	50	±0.25pF	0.75
10	CL21C2R5CBANNN □		2.5pF	50	±0.25pF	0.75
11	CL21C2R7CBANNN □		2.7pF	50	±0.25pF	0.75
12	CL21C030CBANNN □		3.0pF	50	±0.25pF	0.75
13	CL21C3R2CBANNN □		3.2pF	50	±0.25pF	0.75
14	CL21C3R3CBANNN □		3.3pF	50	±0.25pF	0.75
15	CL21C3R6CBANNN □		3.6pF	50	±0.25pF	0.75
16	CL21C3R9CBANNN □		3.9pF	50	±0.25pF	0.75
17	CL21C040CBANNN □		4.0pF	50	±0.25pF	0.75
18	CL21C4R7CBANNN □		4.7pF	50	±0.25pF	0.75
19	CL21C5R6DBANNN □		5.6pF	50	±0.5pF	0.75
20	CL21C060DBANNN □		6.0pF	50	±0.5pF	0.75
21	CL21C6R8DBANNN □		6.8pF	50	±0.5pF	0.75
22	CL21C070DBANNN □		7.0pF	50	±0.5pF	0.75
23	CL21C7R5DBANNN □		7.5pF	50	±0.5pF	0.75
24	CL21C080DBANNN □		8.0pF	50	±0.5pF	0.75
25	CL21C8R2DBANNN □		8.2pF	50	±0.5pF	0.75
26	CL21C090DBANNN □		9.0pF	50	±0.5pF	0.75
27	CL21C100JBANNN □		10pF	50	±5%	0.75
28	CL21C120JBANNN □		12pF	50	±5%	0.75
29	CL21C130JBANNN □		13pF	50	±5%	0.75
30	CL21C140JBANNN □		14pF	50	±5%	0.75
31	CL21C150JBANNN □		15pF	50	±5%	0.75
32	CL21C160JBANNN □		16pF	50	±5%	0.75
33	CL21C180JBANNN □		18pF	50	±5%	0.75
34	CL21C200JBANNN □		20pF	50	±5%	0.75
35	CL21C220JBANNN □		22pF	50	±5%	0.75
36	CL21C240JBANNN □		24pF	50	±5%	0.75
37	CL21C250JBANNN □		25pF	50	±5%	0.75
38	CL21C270JBANNN □		27pF	50	±5%	0.75
39	CL21C300JBANNN □		30pF	50	±5%	0.75
40	CL21C330JBANNN □		33pF	50	±5%	0.75
41	CL21C360JBANNN □		36pF	50	±5%	0.75
42	CL21C390JBANNN □		39pF	50	±5%	0.75
43	CL21C430JBANNN □		43pF	50	±5%	0.75
44	CL21C470JBANNN □		47pF	50	±5%	0.75
45	CL21C510JBANNN □		51pF	50	±5%	0.75

※ □ mark means packaging code. If you want to learn the code or quantity in detail, please see p80.

Product Lineup (General Capacitors-C0G)

	Part Number	Size L×W (mm)	Capacitance	Rated Voltage (Vdc)	Capacitance Tolerance	Thickness Max. (mm)
46	CL21C560JBANNN □	2.00×1.25	56pF	50	±5%	0.75
47	CL21C620JBANNN □		62pF	50	±5%	0.75
48	CL21C680JBANNN □		68pF	50	±5%	0.75
49	CL21C750JBANNN □		75pF	50	±5%	0.75
50	CL21C820JBANNN □		82pF	50	±5%	0.75
51	CL21C910JBANNN □		91pF	50	±5%	0.75
52	CL21C101JBANNN □		100pF	50	±5%	0.75
53	CL21C111JBANNN □		110pF	50	±5%	0.75
54	CL21C121JBANNN □		120pF	50	±5%	0.75
55	CL21C131JBANNN □		130pF	50	±5%	0.75
56	CL21C151JBANNN □		150pF	50	±5%	0.75
57	CL21C161JBANNN □		160pF	50	±5%	0.75
58	CL21C181JBANNN □		180pF	50	±5%	0.75
59	CL21C201JBANNN □		200pF	50	±5%	0.75
60	CL21C221JBANNN □		220pF	50	±5%	0.75
61	CL21C241JBANNN □		240pF	50	±5%	0.75
62	CL21C271JBANNN □		270pF	50	±5%	0.75
63	CL21C301JBANNN □		300pF	50	±5%	0.75
64	CL21C331JBANNN □		330pF	50	±5%	0.75
65	CL21C361JBANNN □		360pF	50	±5%	0.75
66	CL21C391JBANNN □		390pF	50	±5%	0.75
67	CL21C431JBANNN □		430pF	50	±5%	0.75
68	CL21C471JBANNN □		470pF	50	±5%	0.75
69	CL21C511JBANNN □		510pF	50	±5%	0.75
70	CL21C561JBANNN □		560pF	50	±5%	0.75
71	CL21C621JBCNNN □		620pF	50	±5%	0.95
72	CL21C681JBCNNN □		680pF	50	±5%	0.95
73	CL21C751JBCNNN □		750pF	50	±5%	0.95
74	CL21C821JBCNNN □		820pF	50	±5%	0.95
75	CL21C102JBCNNN □		1nF	50	±5%	0.95
76	CL21C122JBFNNN □		1.2nF	50	±5%	1.35
77	CL21C152JBFNNN □		1.5nF	50	±5%	1.35
78	CL21C182JBFNNN □		1.8nF	50	±5%	1.35
79	CL21C222JBFNNN □		2.2nF	50	±5%	1.35
80	CL21C332JAFNNN □		3.3nF	25	±5%	1.35
81	CL21C332JBFNNN □		3.3nF	50	±5%	1.35
82	CL21C392JAANNN □		3.9nF	25	±5%	0.75
83	CL21C392JBFNNN □		3.9nF	50	±5%	1.35
84	CL21C472JAFNNN □	4.7nF	25	±5%	1.35	
85	CL21C472JBFNNN □	4.7nF	50	±5%	1.35	
86	CL21C562JBFNNN □	5.6nF	50	±5%	1.35	
87	CL21C822JAFNNN □	8.2nF	25	±5%	1.35	
88	CL21C103JBFNNN □	10nF	50	±5%	1.35	
1	CL31C0R5CBCNNN □	3.20×1.60	0.5pF	50	±0.25pF	1.0
2	CL31C010CBCNNN □		1.0pF	50	±0.25pF	1.0
3	CL31C1R5CBCNNN □		1.5pF	50	±0.25pF	1.0
4	CL31C1R8CBCNNN □		1.8pF	50	±0.25pF	1.0
5	CL31C020CBCNNN □		2.0pF	50	±0.25pF	1.0
6	CL31C2R2CBCNNN □		2.2pF	50	±0.25pF	1.0
7	CL31C2R7CBCNNN □		2.7pF	50	±0.25pF	1.0

※ □ mark means packaging code. If you want to learn the code or quantity in detail, please see p80.

Part Numbering System

General Capacitors

High Capacitance Capacitors

Super Small Size Capacitors

Medium-High Voltage Capacitors

Array Type Capacitors

Low ESL Capacitors

Reliability Test Condition

Premium Capacitors for Automotive Applications

Packaging Specification

Application Manual for Surface Mounting



Product Lineup (General Capacitors-C0G)

	Part Number	Size L×W (mm)	Capacitance	Rated Voltage (Vdc)	Capacitance Tolerance	Thickness Max. (mm)
8	CL31C030CBCN NN □	3.20×1.60	3.0pF	50	±0.25pF	1.0
9	CL31C3R3CBCN NN □		3.3pF	50	±0.25pF	1.0
10	CL31C040CBCN NN □		4.0pF	50	±0.25pF	1.0
11	CL31C4R7CBCN NN □		4.7pF	50	±0.25pF	1.0
12	CL31C100JBCN NN □		10pF	50	±5%	1.0
13	CL31C120JBCN NN □		12pF	50	±5%	1.0
14	CL31C150JBCN NN □		15pF	50	±5%	1.0
15	CL31C180JBCN NN □		18pF	50	±5%	1.0
16	CL31C200JBCN NN □		20pF	50	±5%	1.0
17	CL31C220JBCN NN □		22pF	50	±5%	1.0
18	CL31C270JBCN NN □		27pF	50	±5%	1.0
19	CL31C300JBCN NN □		30pF	50	±5%	1.0
20	CL31C330JBCN NN □		33pF	50	±5%	1.0
21	CL31C390JBCN NN □		39pF	50	±5%	1.0
22	CL31C470JBCN NN □		47pF	50	±5%	1.0
23	CL31C510JBCN NN □		51pF	50	±5%	1.0
24	CL31C560JBCN NN □		56pF	50	±5%	1.0
25	CL31C680JBCN NN □		68pF	50	±5%	1.0
26	CL31C750JBCN NN □		75pF	50	±5%	1.0
27	CL31C820JBCN NN □		82pF	50	±5%	1.0
28	CL31C101JBCN NN □		100pF	50	±5%	1.0
29	CL31C121JBCN NN □		120pF	50	±5%	1.0
30	CL31C151JBCN NN □		150pF	50	±5%	1.0
31	CL31C181JBCN NN □		180pF	50	±5%	1.0
32	CL31C221JBCN NN □		220pF	50	±5%	1.0
33	CL31C271JBCN NN □		270pF	50	±5%	1.0
34	CL31C331JBCN NN □		330pF	50	±5%	1.0
35	CL31C391JBCN NN □		390pF	50	±5%	1.0
36	CL31C471JBCN NN □		470pF	50	±5%	1.0
37	CL31C561JBCN NN □		560pF	50	±5%	1.0
38	CL31C681JBCN NN □		680pF	50	±5%	1.0
39	CL31C821JBCN NN □	820pF	50	±5%	1.0	
40	CL31C102JBCN NN □	1nF	50	±5%	1.0	
41	CL31C122JBCN NN □	1.2nF	50	±5%	1.0	
42	CL31C152JBCN NN □	1.5nF	50	±5%	1.0	
43	CL31C182JBCN NN □	1.8nF	50	±5%	1.0	
44	CL31C222JBCN NN □	2.2nF	50	±5%	1.0	
45	CL31C272JBFN NN □	2.7nF	50	±5%	1.4	
46	CL31C332JBFN NN □	3.3nF	50	±5%	1.4	
47	CL31C472JBFN NN □	4.7nF	50	±5%	1.4	
48	CL31C682JBHN NN □	6.8nF	50	±5%	1.8	
49	CL31C103JAFN NN □	10nF	25	±5%	1.4	
50	CL31C223JBHN NN □	22nF	50	±5%	1.8	
51	CL31C333JBHN NN □	33nF	50	±5%	1.8	
1	CL32C472JBFN NN □	3.20×2.50	4.7nF	50	±5%	1.45
2	CL32C103JBFN NN □		10nF	50	±5%	1.45
3	CL32C223JBHN NN □		22nF	50	±5%	1.80

※ □ mark means packaging code. If you want to learn the code or quantity in detail, please see p80.

**Product Lineup (General Capacitors-X7R)**

	Part Number	Size L×W (mm)	Capacitance	Rated Voltage (Vdc)	Capacitance Tolerance	Thickness Max. (mm)
1	CL05B471KB5NNN □	1.00×0.50	470pF	50	±10%	0.55
2	CL05B221KB5NNN □		220pF	50	±10%	0.55
3	CL05B681KB5NNN □		680pF	50	±10%	0.55
4	CL05B102KB5NNN □		1nF	50	±10%	0.55
5	CL05B102KA5NNN □		1nF	25	±10%	0.55
6	CL05B222KB5NNN □		2.2nF	50	±10%	0.55
7	CL05B472KB5NNN □		4.7nF	50	±10%	0.55
8	CL05B472KA5NNN □		4.7nF	25	±10%	0.55
9	CL05B682KB5NNN □		6.8nF	50	±10%	0.55
10	CL05B682KA5NNN □		6.8nF	25	±10%	0.55
11	CL05B103KB5NNN □		10nF	50	±10%	0.55
12	CL05B103KA5NNN □		10nF	25	±10%	0.55
13	CL05B223KA5NNN □		22nF	25	±10%	0.55
14	CL05B473KO5NNN □		47nF	16	±10%	0.55
15	CL05B473KP5NNN □		47nF	10	±10%	0.55
16	CL05B683KO5NNN □		68nF	16	±10%	0.55
17	CL05B683KP5NNN □		68nF	10	±10%	0.55
18	CL05B104KO5NNN □		100nF	16	±10%	0.55
19	CL05B104KP5NNN □		100nF	10	±10%	0.55
20	CL05B104KQ5NNN □		100nF	6.3	±10%	0.55
1	CL10B101KB8NNN □	1.60×0.80	100pF	50	±10%	0.9
2	CL10B221KB8NNN □		220pF	50	±10%	0.9
3	CL10B471KB8NNN □		470pF	50	±10%	0.9
4	CL10B681KB8NNN □		680pF	50	±10%	0.9
5	CL10B102KB8NNN □		1nF	50	±10%	0.9
6	CL10B102KA8NNN □		1nF	25	±10%	0.9
7	CL10B222KB8NNN □		2.2nF	50	±10%	0.9
8	CL10B472KB8NNN □		4.7nF	50	±10%	0.9
9	CL10B472KA8NNN □		4.7nF	25	±10%	0.9
10	CL10B682KB8NNN □		6.8nF	50	±10%	0.9
11	CL10B103KB8NNN □		10nF	50	±10%	0.9
12	CL10B103KA8NNN □		10nF	25	±10%	0.9
13	CL10B223KA8NNN □		22nF	25	±10%	0.9
14	CL10B473KB8NNN □		47nF	50	±10%	0.9
15	CL10B473KA8NNN □		47nF	25	±10%	0.9
16	CL10B683KB8NNN □		68nF	50	±10%	0.9
17	CL10B683KA8NNN □		68nF	25	±10%	0.9
18	CL10B104KB8NNN □		100nF	50	±10%	0.9
19	CL10B224KA8NNN □		220nF	25	±10%	0.9
20	CL10B224KO8NNN □		220nF	16	±10%	0.9
21	CL10B225KQ8NNN □		2.2uF	63	±10%	0.9
1	CL21B221KBANNN □	2.00×1.25	220pF	50	±10%	0.75
2	CL21B471KBANNN □		470pF	50	±10%	0.75
3	CL21B681KBANNN □		680pF	50	±10%	0.75
4	CL21B102KBANNN □		1nF	50	±10%	0.75
5	CL21B102KBCNNN □		1nF	50	±10%	0.95
6	CL21B222KBANNN □		2.2nF	50	±10%	0.75
7	CL21B222KBCNNN □		2.2nF	50	±10%	0.95
8	CL21B682KBANNN □		6.8nF	50	±10%	0.75
9	CL21B103KBANNN □		10nF	50	±10%	0.75

※ □ mark means packaging code. If you want to learn the code or quantity in detail, please see p80.

※ For parts of higher capacitance than those above listed, refer to the product lineup of 'High Cacaitance' subcategory.

- Part Numbering System
- General Capacitors
- High Capacitance Capacitors
- Super Small Size Capacitors
- Medium-High Voltage Capacitors
- Array Type Capacitors
- Low ESL Capacitors
- Reliability Test Condition
- Premium Capacitors for Automotive Applications
- Packaging Specification
- Application Manual for Surface Mounting



**Product Lineup (General Capacitors-X7R)**

	Part Number	Size L×W (mm)	Capacitance	Rated Voltage (Vdc)	Capacitance Tolerance	Thickness Max. (mm)	
10	CL21B103KBCNNN □	2.00×1.25	10nF	50	±10%	0.95	
11	CL21B223KBANNN □		22nF	50	±10%	0.75	
12	CL21B223KBCNNN □		22nF	50	±10%	0.95	
13	CL21B473KBANNN □		47nF	50	±10%	0.75	
14	CL21B473KBCNNN □		47nF	50	±10%	0.95	
15	CL21B683KAANNN □		68nF	25	±10%	0.75	
16	CL21B683KBCNNN □		68nF	50	±10%	0.95	
17	CL21B683KBFNNN □		68nF	50	±10%	1.35	
18	CL21B104KBCNNN □		100nF	50	±10%	0.95	
19	CL21B104KBFNNN □		100nF	50	±10%	1.35	
20	CL21B224KBFNNN □		220nF	50	±10%	1.35	
21	CL21B224KAFNNN □		220nF	25	±10%	1.35	
22	CL21B224KOCNNN □		220nF	16	±10%	0.95	
23	CL21B224KOFNNN □		220nF	16	±10%	1.35	
24	CL21B474KBFNNN □		470nF	50	±10%	1.35	
25	CL21B474KAFNNN □		470nF	25	±10%	1.35	
26	CL21B474KOFNNN □		470nF	16	±10%	1.35	
27	CL21B684KOFNNN □		680nF	16	±10%	1.35	
28	CL21B684KPFNNN □		680nF	10	±10%	1.35	
1	CL31B221KBCNNN □		3.20×1.60	220pF	50	±10%	1.0
2	CL31B471KBCNNN □			470pF	50	±10%	1.0
3	CL31B681KBCNNN □			680pF	50	±10%	1.0
4	CL31B102KBCNNN □			1nF	50	±10%	1.0
5	CL31B222KBCNNN □			2.2nF	50	±10%	1.0
6	CL31B472KBCNNN □			4.7nF	50	±10%	1.0
7	CL31B682KBCNNN □			6.8nF	50	±10%	1.0
8	CL31B103KBCNNN □			10nF	50	±10%	1.0
9	CL31B223KBCNNN □			22nF	50	±10%	1.0
10	CL31B473KBCNNN □	47nF		50	±10%	1.0	
11	CL31B683KBCNNN □	68nF		50	±10%	1.0	
12	CL31B104KBCNNN □	100nF		50	±10%	1.0	
13	CL31B104KACNNN □	100nF		25	±10%	1.0	
14	CL31B224KBCNNN □	220nF		50	±10%	1.0	
15	CL31B224KAFNNN □	220nF		25	±10%	1.4	
16	CL31B474KBFNNN □	470nF		50	±10%	1.4	
17	CL31B474KAHNNN □	470nF		25	±10%	1.8	
18	CL31B474KOCNNN □	470nF		16	±10%	1.0	
19	CL31B684KBHNNN □	680nF		50	±10%	1.8	
20	CL31B684KAHNNN □	680nF		25	±10%	1.8	
21	CL31B105KBHNNN □	1μF		50	±10%	1.8	
22	CL31B105KAHNNN □	1μF		25	±10%	1.8	
23	CL31B105KOFNNN □	1μF		16	±10%	1.4	
24	CL31B225KBHNNN □	2.2μF		50	±10%	1.8	
25	CL31B225KAHNNN □	2.2μF		25	±10%	1.8	
26	CL31B225KOHNNN □	2.2μF		16	±10%	1.8	
27	CL31B225KPFNNN □	2.2μF		10	±10%	1.4	
1	CL32B104KBFNNN □	3.20×2.50	100nF	50	±10%	1.45	
2	CL32B224KBFNNN □		220nF	50	±10%	1.45	
3	CL32B105KBFNNN □		1μF	50	±10%	1.45	
4	CL32B105KAHNNN □		1μF	25	±10%	1.8	

※ □ mark means packaging code. If you want to learn the code or quantity in detail, please see p80.

※ For parts of higher capacitance than those above listed, refer to the product lineup of 'High Capacitance' subcategory.

**Product Lineup (General Capacitors-X7R)**

	Part Number	Size L × W (mm)	Capacitance	Rated Voltage (Vdc)	Capacitance Tolerance	Thickness Max. (mm)
5	CL32B104KBFNNN □	3.20×2.50	100nF	50	±10%	1.45
6	CL32B224KBFNNN □		220nF	50	±10%	1.45
7	CL32B105KBFNNN □		1μF	50	±10%	1.45
8	CL32B105KAHNNN □		1μF	25	±10%	1.8
9	CL32B225KBINNN □		2.2μF	50	±10%	2.2
10	CL32B225KAJNNN □		2.2μF	25	±10%	2.7
11	CL32B474KBFNNN □		470nF	50	±10%	1.45
12	CL32B474KAFNNN □		470nF	25	±10%	1.45
13	CL32B475KOINNN □		4.7μF	16	±10%	2.2
1	CL43B224KBFNNN □		4.50×3.20	220nF	50	±10%
2	CL43B474KBFNNN □	470nF		50	±10%	1.45
3	CL43B684KBFNNN □	680nF		50	±10%	1.45
4	CL43B105KBFNNN □	1μF		50	±10%	1.45
5	CL43B106KALNNN □	10μF		25	±10%	3.5
6	CL43B226KPJNNN □	22μF		10	±10%	2.7
1	CL55B475KBJNNN □	5.70×5.00	4.7μF	50	±10%	2.7

Part Numbering System

General Capacitors

High Capacitance Capacitors

Super Small Size Capacitors

Medium-High Voltage Capacitors

Array Type Capacitors

Low ESL Capacitors

Reliability Test Condition

Premium Capacitors for Automotive Applications

Packaging Specification

Application Manual for Surface Mounting

**Product Lineup (General Capacitors-X5R)**

	Part Number	Size L × W (mm)	Capacitance	Rated Voltage (Vdc)	Capacitance Tolerance	Thickness Max. (mm)
1	CL05A223KO5NNN □	1.00×0.50	22nF	16	±10%	0.55
2	CL05A104KA5NNN □		100nF	25	±10%	0.55
3	CL05A104KO5NNN □		100nF	16	±10%	0.55
4	CL05A104KP5NNN □		100nF	10	±10%	0.55
5	CL05A104KQ5NNN □		100nF	6.3	±10%	0.55

※ □ mark means packaging code. If you want to learn the code or quantity in detail, please see p80.

※ For parts of higher capacitance than those above listed, refer to the product lineup of 'High Capacitance' subcategory.

## Product Lineup (General Capacitors-Y5V)

	Part Number	Size L×W (mm)	Capacitance	Rated Voltage (Vdc)	Capacitance Tolerance	Thickness Max. (mm)
1	CL05F103ZB5NNN □	1.0×0.5	10nF	50	+80%~-20%	0.55
2	CL05F103ZO5NNN □		10nF	16	+80%~-20%	0.55
3	CL05F223ZA5NNN □		22nF	25	+80%~-20%	0.55
4	CL05F223ZO5NNN □		22nF	16	+80%~-20%	0.55
5	CL05F473ZO5NNN □		47nF	16	+80%~-20%	0.55
6	CL05F683ZO5NNN □		68nF	16	+80%~-20%	0.55
7	CL05F104ZO5NNN □		100nF	16	+80%~-20%	0.55
1	CL10F103ZB8NNN □	1.6×0.8	10nF	50	+80%~-20%	0.9
2	CL10F223ZB8NNN □		22nF	50	+80%~-20%	0.9
3	CL10F473ZB8NNN □		47nF	50	+80%~-20%	0.9
4	CL10F473ZA8NNN □		47nF	25	+80%~-20%	0.9
5	CL10F473ZO8NNN □		47nF	16	+80%~-20%	0.9
6	CL10F683ZB8NNN □		68nF	50	+80%~-20%	0.9
7	CL10F104ZB8NNN □		100nF	50	+80%~-20%	0.9
8	CL10F104ZA8NNN □		100nF	25	+80%~-20%	0.9
9	CL10F224ZB8NNN □		220nF	50	+80%~-20%	0.9
10	CL10F224ZA8NNN □		220nF	25	+80%~-20%	0.9
11	CL10F225ZP8NNN □		2.2μF	10	+80%~-20%	0.9
12	CL10F225ZQ8NNN □		2.2μF	6.3	+80%~-20%	0.9
1	CL21F103ZBANNN □	2.0×1.25	10nF	50	+80%~-20%	0.75
2	CL21F223ZBANNN □		22nF	50	+80%~-20%	0.75
3	CL21F473ZBANNN □		47nF	50	+80%~-20%	0.75
4	CL21F683ZBANNN □		68nF	50	+80%~-20%	0.75
5	CL21F104ZBANNN □		100nF	50	+80%~-20%	0.75
6	CL21F104ZBCNNN □		100nF	50	+80%~-20%	0.95
7	CL21F224ZBCNNN □		220nF	50	+80%~-20%	0.95
8	CL21F224ZBFNNN □		220nF	50	+80%~-20%	1.35
9	CL21F224ZOANNN □		220nF	16	+80%~-20%	0.75
10	CL21F474ZACNNN □		470nF	25	+80%~-20%	0.95
11	CL21F474ZBFNNN □		470nF	50	+80%~-20%	1.35
12	CL21F474ZBFNNN □		470nF	50	+80%~-20%	1.35
13	CL21F684ZAFNNN □		680nF	25	+80%~-20%	1.35
14	CL21F684ZOANNN □		680nF	16	+80%~-20%	0.75
15	CL21F225ZAFNNN □		2.2μF	25	+80%~-20%	1.35
16	CL21F225ZOFNNN □		2.2μF	16	+80%~-20%	1.35
1	CL31F103ZBCNNN □	3.2×1.6	10nF	50	+80%~-20%	1.0
2	CL31F104ZBCNNN □		100nF	50	+80%~-20%	1.0
3	CL31F224ZBCNNN □		220nF	50	+80%~-20%	1.0
4	CL31F474ZBCNNN □		470nF	50	+80%~-20%	1.0
5	CL31F105ZBCNNN □		1μF	50	+80%~-20%	1.0
6	CL31F105ZAFNNN □		1μF	25	+80%~-20%	1.4
7	CL31F105ZOCNNN □		1μF	16	+80%~-20%	1.0
8	CL31F225ZAFNNN □		2.2μF	25	+80%~-20%	1.4
9	CL31F225ZOCNNN □		2.2μF	16	+80%~-20%	1.0
1	CL32F475ZAHNNN □	3.2×2.5	4.7μF	25	+80%~-20%	1.8
1	CL43A476MQJNNN □	4.5×3.2	10μF	6.3	+80%~-20%	2.7
2	CL43A107MQLNNN □		100μF	6.3	+80%~-20%	3.5

※ □ mark means packaging code. If you want to learn the code or quantity in detail, please see p80.

※ For parts of higher capacitance than those above listed, refer to the product lineup of 'High Capacitance' subcategory.

# High Capacitance Capacitors

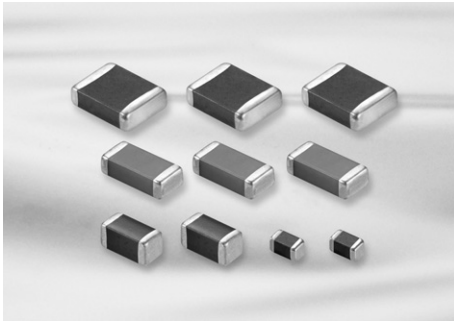

## Feature

- Wide selection of size : from 0402 to 1812
- Highly reliable tolerance and high speed automatic chip placement on PCBs
- Wide capacitance range
- Highly reliable performance
- Highly resistant termination metal
- Tape & reel for surface mount assembly

## Application

- Desktop PC, Note PC, HHP, DC-DC Converter, DSC
- LCD TV, LCD Monitor
- ※ For using special purpose like Military, Medical, Aviation, Automobile device should be following a special specification.

## Structure and Dimensions

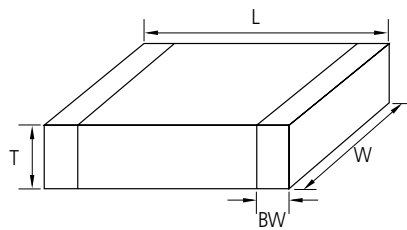

Size Code	EIA Code	Dimension(mm)				
		L	W	T	Thickness Code	BW
05	0402	1.00±0.05	0.50±0.05	0.50±0.05	5	0.2+0.15/-0.1
10	0603	1.60±0.10	0.80±0.10	0.50±0.05	5	0.30±0.20
				0.80±0.10	8	
21	0805	2.00±0.10	1.25±0.10	0.85±0.10	C	0.5+0.2/-0.3
				1.25±0.10	F	
				1.25±0.15	Q	
31	1206	3.20±0.20	1.60±0.20	1.25±0.15	Y	0.50±0.30
				1.60±0.15	F	
				1.60±0.20	H	
32	1210	3.20±0.30	2.50±0.20	0.60±0.10	6	0.60±0.30
				0.85±0.10	C	
				0.90±0.10	9	
				1.60±0.20	H	
				1.80±0.20	U	
2.00±0.20	I					
2.50±0.20	J					
3.20±0.40	v					
42	1808	4.50±0.40	2.00±0.20	2.00±0.20	I	0.80±0.30
43	1812	4.50±0.40	3.20±0.30	3.20±0.30	L	0.80±0.30

Part Numbering System

General Capacitors

High Capacitance Capacitors

Super Small Size Capacitors

Medium-High Voltage Capacitors

Array Type Capacitors

Low ESL Capacitors

Reliability Test Condition

Premium Capacitors for Automotive Applications

Packaging Specification

Application Manual for Surface Mounting





### High Capacitance Table (X5R)

Size(mm)	Vr(V)	Capacitance (uF)									
		0.1	0.22	0.47	1	2.2	4.7	10	22	47	100
0402(1005)	4		■	■	■	■	■	■	■	■	■
	6.3		■	■	■	■	■	■	■	■	■
	10		■	■	■	■	■	■	■	■	■
	16		■	■	■	■	■	■	■	■	■
	25		■	■	■	■	■	■	■	■	■
0603(1608)	4			■	■	■	■	■	■	■	■
	6.3			■	■	■	■	■	■	■	■
	10			■	■	■	■	■	■	■	■
	16			■	■	■	■	■	■	■	■
	25			■	■	■	■	■	■	■	■
	50			■	■	■	■	■	■	■	■
0805(2012)	4				■	■	■	■	■	■	■
	6.3				■	■	■	■	■	■	■
	10				■	■	■	■	■	■	■
	16				■	■	■	■	■	■	■
	25				■	■	■	■	■	■	■
	50				■	■	■	■	■	■	■
1206(3216)	6.3						■	■	■	■	■
	10						■	■	■	■	■
	16						■	■	■	■	■
	25						■	■	■	■	■
	50						■	■	■	■	■
1210(3225)	6.3							■	■	■	■
	10							■	■	■	■
	16							■	■	■	■
	25							■	■	■	■

**High Capacitance Table\_Low Profile (X5R)**

Size(mm)	Tmax (mm)	Vr(V)	Capacitance (uF)						
			1	2.2	4.7	10	22	33	47
0402(1005)	0.3	6.3	X6S						
		10							
		16							
0603(1608)	0.5	6.3							
		10							
		16							
		25							
0805(2012)	0.5	10							
		16							
		25							
	0.95	4							(Tmax=1.0)
		6.3							(Tmax=1.0)
10									
16									
25							X6S		
1206(3216)	0.7	10							
	0.95	6.3							
		10							
		16							
		25						X6S	
		50							
1210(3225)	0.95	16							
	2.0	25							
		35							
		50							

- Part Numbering System
- General Capacitors
- High Capacitance Capacitors
- Super Small Size Capacitors
- Medium-High Voltage Capacitors
- Array Type Capacitors
- Low ESL Capacitors
- Reliability Test Condition
- Premium Capacitors for Automotive Applications
- Packaging Specification
- Application Manual for Surface Mounting



### High Capacitance Table (X6S)

Size(mm)	Vr(V)	Capacitance (uF)									
		0.1	0.22	0.47	1	2.2	4.7	10	22	47	100
0402(1005)	4		■	■	■	■	■	■	■	■	■
	6.3		■	■	■	■	■	■	■	■	■
	10		■	■	■	■	■	■	■	■	■
0603(1608)	4			■	■	■	■	■	■	■	■
	6.3			■	■	■	■	■	■	■	■
	10			■	■	■	■	■	■	■	■
	16			■	■	■	■	■	■	■	■
	25			■	■	■	■	■	■	■	■
0805(2012)	4				■	■	■	■	■	■	■
	6.3				■	■	■	■	■	■	■
	10				■	■	■	■	■	■	■
	16				■	■	■	■	■	■	■
	25				■	■	■	■	■	■	■
1206(3216)	6.3						■	■	■	■	■
	10						■	■	■	■	■
	16						■	■	■	■	■
	25						■	■	■	■	■
1210(3225)	6.3							■	■	■	■
	10							■	■	■	■
	16							■	■	■	■
	25							■	■	■	■

## High Capacitance Table (X7R)

Size(mm)	Vr(V)	Capacitance (uF)									
		0.1	0.22	0.47	1	2.2	4.7	10	22	47	100
0402(1005)	6.3		■								
	10		■								
	16		■								
0603(1608)	6.3			■	■	■	■				
	10			■	■	■	■				
	16			■	■	■	■				
	25			■	■	■	■				
	50										
0805(2012)	6.3				■	■	■	■	■		
	10				■	■	■	■	■		
	16				■	■	■	■	■		
	25				■	■	■	■	■	X7S	
	35				■	■					
	50				■	■					
1206(3216)	6.3						■	■	■		
	10						■	■	■		
	16						■	■	■		
	25						■	■	■		
	35						■	■	■		
	50						■	■			
1210(3225)	6.3							■	■	■	■
	10							■	■	■	
	16							■	■	■	
	25							■	■	■	
	50							■	■		

- Part Numbering System
- General Capacitors
- High Capacitance Capacitors**
- Super Small Size Capacitors
- Medium-High Voltage Capacitors
- Array Type Capacitors
- Low ESL Capacitors
- Reliability Test Condition
- Premium Capacitors for Automotive Applications
- Packaging Specification
- Application Manual for Surface Mounting



Product Lineup (High Capacitance-X5R)

	Part Number	Size L×W (mm)	Capacitance	Rated Voltage (Vdc)	Capacitance Tolerance	Thickness Max. (mm)
1	CL05A224KQ5NNN □	100×0.50	0.22 μF	6.3	±10%	0.55
2	CL05A224KR5NNN □		0.22 μF	4	±10%	0.55
3	CL05A224KA5NNN □		0.22 μF	25	±10%	0.55
4	CL05A224KO5NNN □		0.22 μF	16	±10%	0.55
5	CL05A224KP5NNN □		0.22 μF	10	±10%	0.55
6	CL05A334KA5NNN □		0.33 μF	25	±10%	0.55
7	CL05A334KQ5NNN □		0.33 μF	6.3	±10%	0.55
8	CL05A334KR5NNN □		0.33 μF	4	±10%	0.55
9	CL05A474KA5NNN □		0.47 μF	25	±10%	0.55
10	CL05A474KO5NNN □		0.47 μF	16	±10%	0.55
11	CL05A474KP5NNN □		0.47 μF	10	±10%	0.55
12	CL05A474KQ5NNN □		0.47 μF	6.3	±10%	0.55
13	CL05A474KR5NNN □		0.47 μF	4	±10%	0.55
14	CL05A105KA5NQN □		1 μF	25	±10%	0.60
15	CL05A105KO5NNN □		1 μF	16	±10%	0.55
16	CL05A105KO3LQN □		1 μF	16	±10%	0.33
17	CL05A105KP5NNN □		1 μF	10	±10%	0.55
18	CL05A105KP3LNN □		1 μF	10	±10%	0.33
19	CL05A105KQ5NNN □		1 μF	6.3	±10%	0.55
20	CL05A105KQ3LNN □		1 μF	6.3	±10%	0.33
21	CL05A105KR5NNN □		1 μF	4	±10%	0.55
22	CL05A105KR3LNN □		1 μF	4	±10%	0.33
23	CL05A225KO5NQN □		2.2 μF	16	±10%	0.60
24	CL05A225MP5NSN □		2.2 μF	10	±20%	0.57
25	CL05A225KP3LRN □		2.2 μF	10	±10%	0.33
26	CL05A225MQ5NNN □		2.2 μF	6.3	±20%	0.55
27	CL05A225KQ3LRN □		2.2 μF	6.3	±10%	0.33
28	CL05A225MR5NNN □		2.2 μF	4	±20%	0.55
29	CL05A225KR3LRN □		2.2 μF	4	±10%	0.33
30	CL05A475MP5NRN □		4.7 μF	10	±20%	0.65
31	CL05A475MQ5NRN □		4.7 μF	6.3	±20%	0.65
32	CL05A475MR5NRN □		4.7 μF	4	±20%	0.65
33	CL05A106MQ5NUN □		10 μF	6.3	±20%	0.70
34	CL05A106MR5NRN □		10 μF	4	±20%	0.65
1	CL10A474KB8NNN □	1.60×0.80	0.47 μF	50	±10%	0.90
2	CL10A474KA8NNN □		0.47 μF	25	±10%	0.90
3	CL10A474KP8NNN □		0.47 μF	10	±10%	0.90
4	CL10A474KQ8NNN □		0.47 μF	6.3	±10%	0.90
5	CL10A474KR8NNN □		0.47 μF	4	±10%	0.90
6	CL10A105KB8NNN □		1 μF	50	±10%	0.90
7	CL10A105KA85NN □		1 μF	25	±10%	0.55
8	CL10A105KA8NNN □		1 μF	25	±10%	0.90
9	CL10A105KO8NNN □		1 μF	16	±10%	0.90
10	CL10A105KO5LNN □		1 μF	16	±10%	0.55
11	CL10A105KP8NNN □		1 μF	10	±10%	0.90
12	CL10A105KP5LNN □		1 μF	10	±10%	0.55
13	CL10A105KQ8NNN □		1 μF	6.3	±10%	0.90
14	CL10A105KQ5LNN □		1 μF	6.3	±10%	0.55

※ □ mark means packaging code. If you want to learn the code or quantity in detail, please see p80.

Part Numbering System

General Capacitors

High Capacitance Capacitors

Super Small Size Capacitors

Medium-High Voltage Capacitors

Array Type Capacitors

Low ESL Capacitors

Reliability Test Condition

Premium Capacitors for Automotive Applications

Packaging Specification

Application Manual for Surface Mounting



Product Lineup (High Capacitance-X5R)

	Part Number	Size L×W (mm)	Capacitance	Rated Voltage (Vdc)	Capacitance Tolerance	Thickness Max. (mm)
15	CL10A105KR8N <sup>□</sup>	1.60×0.80	1 μF	4	±10%	0.90
16	CL10A105KR5L <sup>□</sup>		1 μF	4	±10%	0.55
17	CL10A225KA8N <sup>□</sup>		2.2 μF	25	±10%	0.90
18	CL10A105KA85N <sup>□</sup>		2.2 μF	25	±10%	0.55
19	CL10A225KO8N <sup>□</sup>		2.2 μF	16	±10%	0.90
20	CL10A225KO5L <sup>□</sup>		2.2 μF	16	±10%	0.55
21	CL10A225KP8N <sup>□</sup>		2.2 μF	10	±10%	0.90
22	CL10A225KP5L <sup>□</sup>		2.2 μF	10	±10%	0.55
23	CL10A225KQ8N <sup>□</sup>		2.2 μF	6.3	±10%	0.90
24	CL10A225KQ5L <sup>□</sup>		2.2 μF	6.3	±10%	0.55
25	CL10A225KR8N <sup>□</sup>		2.2 μF	4	±10%	0.90
26	CL10A225KR5L <sup>□</sup>		2.2 μF	4	±10%	0.55
27	CL10A335KQ8N <sup>□</sup>		3.3 μF	6.3	±10%	0.90
28	CL10A335KR8N <sup>□</sup>		3.3 μF	4	±10%	0.90
29	CL10A475KA8N <sup>□</sup>		4.7 μF	25	±10%	0.95
30	CL10A475KO8N <sup>□</sup>		4.7 μF	16	±10%	0.90
31	CL10A475KP8N <sup>□</sup>		4.7 μF	10	±10%	0.90
32	CL10A475KP5N <sup>□</sup>		4.7 μF	10	±10%	0.55
33	CL10A475KQ5L <sup>□</sup>		4.7 μF	6.3	±10%	0.55
34	CL10A475KQ8N <sup>□</sup>		4.7 μF	6.3	±10%	0.90
35	CL10A475KR5L <sup>□</sup>		4.7 μF	4	±10%	0.55
36	CL10A475KR8N <sup>□</sup>		4.7 μF	4	±10%	0.90
37	CL10A106MO8N <sup>□</sup>		10 μF	16	±20%	0.95
38	CL10A106MP8N <sup>□</sup>		10 μF	10	±20%	0.90
39	CL10A106KQ8N <sup>□</sup>		10 μF	6.3	±10%	0.90
40	CL10A106MQ5N <sup>□</sup>		10 μF	6.3	±10%	0.55
41	CL10A106KR8N <sup>□</sup>		10 μF	4	±10%	0.90
42	CL10A106MR5N <sup>□</sup>		10 μF	4	±10%	0.55
43	CL10A226MQ8N <sup>□</sup>		22 μF	6.3	±20%	1.00
44	CL10A226MR8N <sup>□</sup>		22 μF	4	±20%	1.00
1	CL21A105KBQ <sup>□</sup>	2.00×1.25	1 μF	50	±10%	1.40
2	CL21A105KAF <sup>□</sup>		1 μF	25	±10%	1.35
3	CL21A105KA6L <sup>□</sup>		1 μF	25	±10%	0.70
4	CL21A105KOF <sup>□</sup>		1 μF	16	±10%	1.35
5	CL21A105KO6L <sup>□</sup>		1 μF	16	±10%	0.70
6	CL21A105KQF <sup>□</sup>		1 μF	6.3	±10%	1.35
7	CL21A105KRF <sup>□</sup>		1 μF	4	±10%	1.35
8	CL21A225KBQ <sup>□</sup>		2.2 μF	50	±10%	1.40
9	CL21A225KAF <sup>□</sup>		2.2 μF	25	±10%	1.35
10	CL21A225KO6L <sup>□</sup>		2.2 μF	16	±10%	0.70
11	CL21A225KOF <sup>□</sup>		2.2 μF	16	±10%	1.35
12	CL21A225KPF <sup>□</sup>		2.2 μF	10	±10%	1.35
13	CL21A225KQF <sup>□</sup>		2.2 μF	6.3	±10%	1.35
14	CL21A225KRF <sup>□</sup>		2.2 μF	4	±10%	1.35
15	CL21A475KBQ <sup>□</sup>		4.7 μF	50	±10%	1.40
16	CL21A475KAQ <sup>□</sup>		4.7 μF	25	±10%	1.40
17	CL21A475KACL <sup>□</sup>		4.7 μF	25	±10%	0.95
18	CL21A475KOF <sup>□</sup>		4.7 μF	16	±10%	1.35
19	CL21A475KOCL <sup>□</sup>		4.7 μF	16	±10%	0.70
20	CL21A475KPF <sup>□</sup>		4.7 μF	10	±10%	1.35

※ □ mark means packaging code. If you want to learn the code or quantity in detail, please see p 80.

**Product Lineup (High Capacitance-X5R)**

	Part Number	Size L×W (mm)	Capacitance	Rated Voltage (Vdc)	Capacitance Tolerance	Thickness Max. (mm)
21	CL21A475KPCLNN □	2.00×1.25	4.7 μF	10	±10%	0.95
22	CL21A475KQFNNN □		4.7 μF	6.3	±10%	1.35
23	CL21A475KQCLNN □		4.7 μF	6.3	±10%	0.95
24	CL21A475KRFNNN □		4.7 μF	4	±10%	1.35
25	CL21A106KAYNNN □		10 μF	25	±10%	1.45
26	CL21A106KACLRN □		10 μF	25	±10%	0.95
27	CL21A106KOFNNN □		10 μF	16	±10%	1.35
28	CL21A106KOQNNN □		10 μF	16	±10%	1.40
29	CL21A106KOCLRN □		10 μF	16	±10%	0.70
30	CL21A106KPFNNN □		10 μF	10	±10%	1.35
31	CL21A106KPCLQN □		10 μF	10	±20%	0.95
32	CL21A106KQFNNN □		10 μF	6.3	±10%	1.35
33	CL21A106KQCLNN □		10 μF	6.3	±10%	0.95
34	CL21A475KRCLNN □		4.7 μF	4	±10%	0.95
35	CL21A106KRFNNN □		10 μF	4	±10%	1.35
36	CL21A106KRCLNN □		10 μF	4	±10%	0.95
37	CL21A226MPQNNN □		22 μF	10	±20%	1.40
38	CL21A226MPCLRN □		22 μF	10	±20%	0.95
39	CL21A226MQQNNN □		22 μF	6.3	±20%	1.40
40	CL21A226MQCLRN □		22 μF	6.3	±20%	0.95
41	CL21A226MRQNNN □		22 μF	4	±20%	1.40
42	CL21A226MRCLRN □		22 μF	4	±20%	0.95
43	CL21A336MQELNN □		33 μF	6.3	±20%	1.20
44	CL21A336MQ9LNN □		33 μF	6.3	±20%	1.00
45	CL21A336MRELNN □		33 μF	4	±20%	1.20
46	CL21A336MR9LNN □		33 μF	4	±20%	1.00
47	CL21A476MQYNNN □		47 μF	6.3	±20%	1.45
48	CL21A476MRYNNN □		47 μF	4.0	±20%	1.45
1	CL31A475KBHNNN □	3.20×1.60	4.7 μF	50	±10%	1.80
2	CL31A475KB9LNN □		4.7 μF	50	±10%	1.00
3	CL31A475KAHNNN □		4.7 μF	25	±10%	1.80
4	CL31A475KACLNN □		4.7 μF	25	±10%	0.95
5	CL31A475KOHNNN □		4.7 μF	16	±10%	1.80
6	CL31A475KOCLNN □		4.7 μF	16	±10%	0.95
7	CL31A475KPHNNN □		4.7 μF	10	±10%	1.80
8	CL31A475KQHNNN □		4.7 μF	6.3	±10%	1.80
9	CL31A475KRHNNN □		4.7 μF	4	±10%	1.80
10	CL31A106KBHNNN □		10 μF	50	±10%	1.80
11	CL31A106KAHNNN □		10 μF	25	±10%	1.80
12	CL31A106KACLNN □		10 μF	25	±10%	0.95
13	CL31A106KOHNNN □		10 μF	16	±10%	1.80
14	CL31A106KOCLNN □		10 μF	16	±10%	0.95
15	CL31A106KPHNNN □		10 μF	10	±10%	1.80
16	CL31A106KPCLNN □		10 μF	10	±10%	0.95
17	CL31A106KQHNNN □		10 μF	6.3	±10%	1.80
18	CL31A106KRHNNN □		10 μF	4	±10%	1.80
19	CL31A156KQHNNN □		15 μF	6.3	±10%	1.80
20	CL31A156KRHNNN □		15 μF	4	±10%	1.80
21	CL31A226KAHNNN □		22 μF	25	±10%	1.80
22	CL31A226KOHNNN □		22 μF	16	±10%	1.80

Part Numbering System

General Capacitors

High Capacitance Capacitors

Super Small Size Capacitors

Medium-High Voltage Capacitors

Array Type Capacitors

Low ESL Capacitors

Reliability Test Condition

Premium Capacitors for Automotive Applications

Packaging Specification

Application Manual for Surface Mounting

※ □ mark means packaging code. If you want to learn the code or quantity in detail, please see p 80.





**Product Lineup (High Capacitance-X5R)**

	Part Number	Size L×W (mm)	Capacitance	Rated Voltage (Vdc)	Capacitance Tolerance	Thickness Max. (mm)	
23	CL31A226KOC LNN □	3.20×1.60	22μF	16	±10%	0.95	
24	CL31A226KPH LNN □		22μF	10	±10%	1.80	
25	CL31A226KPCL LNN □		22μF	10	±10%	0.95	
26	CL31A226KQH LNN □		22μF	6.3	±10%	1.80	
27	CL31A226KRH LNN □		22μF	4.0	±10%	1.80	
28	CL31A476MQH LNN □		47μF	6.3	±20%	1.80	
29	CL31A476MRH LNN □		47μF	4.0	±20%	1.80	
30	CL31A107MQH LNN □		100μF	6.3	±20%	1.80	
31	CL31A107MRH LNN □		100μF	4.0	±20%	1.80	
1	CL32A106KQC LNN □		3.20×2.50	10μF	6.3	±10%	0.95
2	CL32A106KRCL LNN □			10μF	4.0	±10%	0.95
3	CL32A106KBUL LNN □	10μF		50	±10%	2.00	
4	CL32A106KAJ LNN □	10μF		25	±10%	2.70	
5	CL32A106KAUL LNN □	10μF		25	±10%	2.00	
6	CL32A106KOJ LNN □	10μF		16	±10%	2.70	
7	CL32A106KPJ LNN □	10μF		10	±10%	2.70	
8	CL32A226KAJ LNN □	22μF		25	±10%	2.70	
9	CL32A226KOJ LNN □	22μF		16	±10%	2.70	
10	CL32A226KOC LNN □	22μF		16	±10%	0.95	
11	CL32A226KPJ LNN □	22μF		10	±10%	2.70	
12	CL32A226KQJ LNN □	22μF		6.3	±10%	2.70	
13	CL32A226MQC LNN □	22μF		6.3	±20%	0.95	
14	CL32A226KRJ LNN □	22μF		4.0	±10%	2.70	
15	CL32A226MRCL LNN □	22μF		4.0	±20%	0.95	
16	CL32A476KPJ LNN □	47μF		10	±10%	2.70	
17	CL32A476MQJ LNN □	47μF		6.3	±20%	2.70	
18	CL32A476MRJ LNN □	47μF		4.0	±20%	2.70	
19	CL32A107MPV LNN □	100μF		10	±20%	2.80	
20	CL32A107MQV LNN □	100μF		6.3	±20%	2.80	
21	CL32A107MRV LNN □	100μF		4.0	±20%	2.80	
1	CL43A476MQJ LNN □	4.50×3.20	47μF	6.3	±20%	2.70	
2	CL43A476MRJ LNN □		47μF	4.0	±20%	2.70	
3	CL43A107KQL LNN □		100μF	6.3	±20%	3.50	
4	CL43A107KRL LNN □		100μF	4.0	±20%	3.50	

※ □ mark means packaging code. If you want to learn the code or quantity in detail, please see p 80.

**Product Lineup (High Capacitance-X6S)**

	Part Number	Size L×W (mm)	Capacitance	Rated Voltage (Vdc)	Capacitance Tolerance	Thickness Max. (mm)
1	CL05X224KP5NNN □	1.00×0.50	0.22 μF	10	±10%	0.55
2	CL05X224KQ5NNN □		0.22 μF	6.3	±10%	0.55
3	CL05X224KR5NNN □		0.22 μF	4	±10%	0.55
4	CL05X474KP5NNN □		0.47 μF	10	±10%	0.55
5	CL05X474KQ5NNN □		0.47 μF	6.3	±10%	0.55
6	CL05X474KR5NNN □		0.47 μF	4	±10%	0.55
7	CL05X105KP5NNN □		1 μF	10	±10%	0.55
8	CL05X105MQ3LNN □		1 μF	6.3	±20%	0.33
9	CL05X105KQ5NNN □		1 μF	6.3	±10%	0.55
10	CL05X105MR3LNN □		1 μF	4	±20%	0.33
11	CL05X105KR5NNN □		1 μF	4	±10%	0.55
12	CL05X225MQ5NSN □		2.2 μF	6.3	±20%	0.57
13	CL05X225MR5NSN □		2.2 μF	4	±20%	0.57
1	CL10X474KA8NNN □	1.60×0.80	0.47 μF	25	±10%	0.90
2	CL10X474KO8NNN □		0.47 μF	16	±10%	0.90
3	CL10X474KP8NNN □		0.47 μF	10	±10%	0.90
4	CL10X474KQ8NNN □		0.47 μF	6.3	±10%	0.90
5	CL10X474KR8NNN □		0.47 μF	4	±10%	0.90
6	CL10X105KA8NNN □		1 μF	25	±10%	0.90
7	CL10X105KO8NNN □		1 μF	16	±10%	0.90
8	CL10X105KP8NNN □		1 μF	10	±10%	0.90
9	CL10X105KQ8NNN □		1 μF	6.3	±10%	0.90
10	CL10X105KR8NNN □		1 μF	4	±10%	0.90
11	CL10X225KA8NQN □		2.2 μF	25	±10%	0.90
12	CL10X225KO8NNN □		2.2 μF	16	±10%	0.90
13	CL10X225KP8NNN □		2.2 μF	10	±10%	0.90
14	CL10X225KQ8NNN □		2.2 μF	6.3	±10%	0.90
15	CL10X225KR8NNN □		2.2 μF	4	±10%	0.90
16	CL10X475KA8NQN □		4.7 μF	25	±10%	0.90
17	CL10X475KO8NQN □		4.7 μF	16	±10%	0.90
18	CL10X475KP5NNN □		4.7 μF	10	±10%	0.90
19	CL10X475KQ8NNN □		4.7 μF	6.3	±10%	0.90
20	CL10X475KR8NNN □		4.7 μF	4	±10%	0.90
21	CL10X106MP8NNN □		10 μF	10	±20%	0.90
22	CL10X106KQ8NNN □		10 μF	6.3	±10%	0.90
23	CL10X106KR8NNN □		10 μF	4	±10%	0.90
1	CL21X105KAFNNN □	2.00×1.25	1 μF	25	±10%	1.35
2	CL21X105KOFNNN □		1 μF	16	±10%	1.35
3	CL21X105KPFNNN □		1 μF	10	±10%	1.35
4	CL21X105KQFNNN □		1 μF	6.3	±10%	1.35
5	CL21X105KRFNNN □		1 μF	4	±10%	1.35
6	CL21X225KAFNNN □		2.2 μF	25	±10%	1.35
7	CL21X225KOFNNN □		2.2 μF	16	±10%	1.35
8	CL21X225KPFNNN □		2.2 μF	10	±10%	1.35
9	CL21X225KQFNNN □		2.2 μF	6.3	±10%	1.35
10	CL21X225KRFNNN □		2.2 μF	4	±10%	1.35
11	CL21X475KAQNNN □		4.7 μF	25	±10%	1.40
12	CL21X475KOFNNN □		4.7 μF	16	±10%	1.35
13	CL21X475KPFNNN □		4.7 μF	10	±10%	1.35
14	CL21X475KQFNNN □		4.7 μF	6.3	±10%	1.35

※ □ mark means packaging code. If you want to learn the code or quantity in detail, please see p 80.

- Part Numbering System
- General Capacitors
- High Capacitance Capacitors
- Super Small Size Capacitors
- Medium-High Voltage Capacitors
- Array Type Capacitors
- Low ESL Capacitors
- Reliability Test Condition
- Premium Capacitors for Automotive Applications
- Packaging Specification
- Application Manual for Surface Mounting



Product Lineup (High Capacitance -X7R)

	Part Number	Size L×W (mm)	Capacitance	Rated Voltage (Vdc)	Capacitance Tolerance	Thickness Max. (mm)	
15	CL21X475KRFNNN □	2.00×1.25	4.7μF	4	±10%	1.35	
16	CL21X106KACLRN □		10μF	25	±10%	0.95	
17	CL21X106KAYNNN □		10μF	25	±10%	1.45	
18	CL21X106KOYNNN □		10μF	16	±10%	1.45	
19	CL21X106KPCLNN □		10μF	10	±10%	0.95	
20	CL21X106KPYNNN □		10μF	10	±10%	1.45	
21	CL21X106KQQNNN □		10μF	6.3	±10%	1.40	
22	CL21X106KRQNNN □		10μF	4	±10%	1.40	
23	CL21X106KRCLNN □		10μF	4	±10%	0.95	
24	CL21X226MQQNNN □		22μF	6.3	±20%	1.40	
25	CL21X226MRQNNN □		22μF	4	±20%	1.40	
26	CL21X476MRYNNN □		47μF	4	±20%	1.45	
1	CL31X475KAHNNN □		3.20×1.60	4.7μF	25	±10%	1.80
2	CL31X475KACLNN □			4.7μF	25	±10%	0.95
3	CL31X475KOHNNN □	4.7μF		16	±10%	1.80	
4	CL31X475KPHNNN □	4.7μF		10	±10%	1.80	
5	CL31X475MQHNNN □	4.7μF		6.3	±20%	1.80	
6	CL31X475KRHNNN □	4.7μF		4	±10%	1.80	
7	CL31X106KACLNN □	10μF		25	±10%	0.95	
8	CL31X106KAHNNN □	10μF		25	±10%	1.80	
9	CL31X106KOHNNN □	10μF		16	±10%	1.80	
10	CL31X106KPHNNN □	10μF		10	±10%	1.80	
11	CL31X106KHNNN □	10μF		6.3	±10%	1.80	
12	CL31X106KRHNNN □	10μF		4	±10%	1.80	
13	CL31X226KOHNNN □	22μF		16	±10%	1.80	
14	CL31X226KPHNNN □	22μF		10	±10%	1.80	
15	CL31X226KHNNN □	22μF		6.3	±10%	1.80	
16	CL31X226KRHNNN □	22μF		4	±10%	1.80	
17	CL31X107MQHNNN □	100μF		6.3	±20%	1.80	
18	CL31X107MRHNNN □	100μF		4	±20%	1.80	
1	CL32X106KAUNNN □	3.20×2.50	10μF	25	±10%	2.00	
2	CL32X106KOJNNN □		10μF	16	±10%	2.70	
3	CL32X106KPJNNN □		10μF	10	±10%	2.70	
4	CL32X106KQJNNN □		10μF	6.3	±10%	2.70	
5	CL32X106KRJNNN □		10μF	4	±10%	2.70	
6	CL32X226KAJNNN □		22μF	25	±10%	2.70	
7	CL32X226KOJNNN □		22μF	16	±10%	2.70	
8	CL32X226KPJNNN □		22μF	10	±10%	2.70	
9	CL32X226KQJNNN □		22μF	6.3	±10%	2.70	
10	CL32X226KRJNNN □		22μF	4	±10%	2.70	
11	CL32X476MPJNNN □		47μF	10	±20%	2.70	
12	CL32X476KQJNNN □		47μF	6.3	±10%	2.70	
13	CL32X476KRJNNN □		47μF	4	±10%	2.70	
14	CL32X107MQVNNN □		100μF	6.3	±20%	2.70	
15	CL32X107MRVNNN □		100μF	4	±20%	2.70	

※ □ mark means packaging code. If you want to learn the code or quantity in detail, please see p80.

**Product Lineup (High Capacitance -X7R)**

	Part Number	Size L×W (mm)	Capacitance	Rated Voltage (Vdc)	Capacitance Tolerance	Thickness Max. (mm)
1	CL05B224KO5NNN □	1.00×0.50	0.22 μF	16	±10%	0.55
2	CL05B224KP5NNN □		0.22 μF	10	±10%	0.55
3	CL05B224KQ5NNN □		0.22 μF	6.3	±10%	0.55
1	CL10B474KA8NNN □	1.60×0.80	0.47 μF	25	±10%	0.90
2	CL10B474KO8NNN □		0.47 μF	16	±10%	0.90
3	CL10B474KP8NNN □		0.47 μF	10	±10%	0.90
4	CL10B474KQ8NNN □		0.47 μF	6.3	±10%	0.90
5	CL10B105KA8NNN □		1 μF	25	±10%	0.90
6	CL10B105KO8NNN □		1 μF	16	±10%	0.90
7	CL10B105KP8NNN □		1 μF	10	±10%	0.90
8	CL10B105KQ8NNN □		1 μF	6.3	±10%	0.90
9	CL10B225KP8NNN □		2.2 μF	10	±10%	0.90
10	CL10B225KQ8NNN □		2.2 μF	6.3	±10%	0.90
1	CL21B105KBFNNN □	2.00×1.25	1 μF	50	±10%	1.35
2	CL21B105KLFNNN □		1 μF	35	±10%	1.35
3	CL21B105KAFNNN □		1 μF	25	±10%	1.35
4	CL21B105KOFNNN □		1 μF	16	±10%	1.35
5	CL21B105KPFNNN □		1 μF	10	±10%	1.35
6	CL21B105KQFNNN □		1 μF	6.3	±10%	1.35
7	CL21B225KAFNNN □		2.2 μF	25	±10%	1.35
8	CL21B225KOFNNN □		2.2 μF	16	±10%	1.35
9	CL21B225KPFNNN □		2.2 μF	10	±10%	1.35
10	CL21B225KQFNNN □		2.2 μF	6.3	±10%	1.35
11	CL21B475KOFNFN □		4.7 μF	16	±10%	1.35
12	CL21B475KPFNNN □		4.7 μF	10	±10%	1.35
13	CL21B475KQQNNN □		4.7 μF	6.3	±10%	1.35
14	CL21B106KOQNNN □		10 μF	16	±10%	1.40
15	CL21B106KPQNNN □		10 μF	10	±10%	1.35
16	CL21B106KQQNNN □		10 μF	6.3	±10%	1.35
1	CL31B475KBHNNN □	3.20×1.60	4.7 μF	50	±10%	1.80
2	CL31B475KLHNNN □		4.7 μF	35	±10%	1.80
3	CL31B475KAHNNN □		4.7 μF	25	±10%	1.80
4	CL31B475KOHNNN □		4.7 μF	16	±10%	1.80
5	CL31B475KPHNNN □		4.7 μF	10	±10%	1.80
6	CL31B475KQHNNN □		4.7 μF	6.3	±10%	1.80
7	CL31B106KLHNNN □		10 μF	35	±10%	1.80
8	CL31B106KAHNNN □		10 μF	25	±10%	1.80
9	CL31B106KOHNNN □		10 μF	16	±10%	1.80
10	CL31B106KPHNNN □		10 μF	10	±10%	1.80
11	CL31B106KQHNNN □		10 μF	6.3	±10%	1.80
1	CL32B106KBJNNN □	3.20×2.50	10 μF	50	±10%	2.70
2	CL32B106KAJNNN □		10 μF	25	±10%	2.70
3	CL32B106KOJNNN □		10 μF	16	±10%	2.70
4	CL32B106KPINNN □		10 μF	10	±10%	2.70
5	CL32B106KQJNNN □		10 μF	6.3	±10%	2.70
6	CL32B226KAJNNN □		22 μF	25	±10%	2.70
7	CL32B226KOJNNN □		22 μF	16	±10%	2.70
8	CL32B226KPJNNN □		22 μF	10	±10%	2.70
9	CL32B226KQJNNN □		22 μF	6.3	±10%	2.70
10	CL32B476MQJNNN □		47 μF	6.3	±20%	2.70

※ □ mark means packaging code. If you want to learn the code or quantity in detail, please see p80.

- Part Numbering System
- General Capacitors
- High Capacitance Capacitors
- Super Small Size Capacitors
- Medium-High Voltage Capacitors
- Array Type Capacitors
- Low ESL Capacitors
- Reliability Test Condition
- Premium Capacitors for Automotive Applications
- Packaging Specification
- Application Manual for Surface Mounting

## Product Lineup (High Capacitance -Y5V)

	Part Number	Size L×W (mm)	Capacitance	Rated Voltage (Vdc)	Capacitance Tolerance	Thickness Max. (mm)	
1	CL05F224ZO5NNN □	1.00×0.50	0.22μF	16	80%/-20%	0.55	
2	CL05F224ZP5NNN □		0.22μF	10	80%/-20%	0.55	
3	CL05F224ZQ5NNN □		0.22μF	6.3	80%/-20%	0.55	
4	CL05F474ZP5NNN □		0.47μF	10	80%/-20%	0.55	
5	CL05F474ZQ5NNN □		0.47μF	6.3	80%/-20%	0.55	
6	CL05F105ZQ5NNN □		1μF	6.3	80%/-20%	0.55	
1	CL10F474ZB8NNN □	1.60×0.80	0.47μF	50	80%/-20%	0.90	
2	CL10F474ZA8NNN □		0.47μF	25	80%/-20%	0.90	
3	CL10F474ZO8NNN □		0.47μF	16	80%/-20%	0.90	
4	CL10F474ZP8NNN □		0.47μF	10	80%/-20%	0.90	
5	CL10F105ZO8NNN □		1μF	16	80%/-20%	0.90	
6	CL10F105ZP8NNN □		1μF	10	80%/-20%	0.90	
7	CL10F225ZP8NNN □		2.2μF	10	80%/-20%	0.90	
8	CL10F225ZQ8NNN □		2.2μF	6.3	80%/-20%	0.90	
9	CL10F475ZQ8NNN □		4.7μF	6.3	80%/-20%	0.90	
1	CL21F105ZBFNNN □	2.00×1.25	1μF	50	80%/-20%	1.35	
2	CL21F105ZAFNNN □		1μF	25	80%/-20%	1.35	
3	CL21F105ZOFNNN □		1μF	16	80%/-20%	1.35	
4	CL21F225ZAFNNN □		2.2μF	25	80%/-20%	1.35	
5	CL21F225ZOFNNN □		2.2μF	16	80%/-20%	1.35	
6	CL21F475ZQFNNN □		4.7μF	6.3	80%/-20%	1.35	
1	CL21F475ZOFNNN □		4.7μF	16	80%/-20%	1.35	
2	CL21F475ZPFNNN □		4.7μF	10	80%/-20%	1.35	
3	CL21F106ZPFNNN □		10μF	10	80%/-20%	1.35	
4	CL21F106ZPCLNN □		10μF	10	80%/-20%	0.95	
5	CL21F106ZQFNNN □		10μF	6.3	80%/-20%	1.35	
6	CL21F106ZQCLNN □		10μF	6.3	80%/-20%	0.95	
1	CL31F475ZOHNNN □		3.20×1.60	4.7μF	16	80%/-20%	1.80
2	CL31F475ZPHNNN □			4.7μF	10	80%/-20%	1.80
3	CL31F475ZQHNNN □	4.7μF		6.3	80%/-20%	1.80	
4	CL31F106ZOHNNN □	10μF		16	80%/-20%	1.80	
5	CL31F106ZPHNNN □	10μF		10	80%/-20%	1.80	
6	CL31F106ZQHNNN □	10μF		6.3	80%/-20%	1.80	
7	CL31F226ZPHNNN □	22μF		10	80%/-20%	1.80	
8	CL31F226ZQHNNN □	22μF		6.3	80%/-20%	1.80	
1	CL32F106ZAHLNN □	3.20×2.50	10μF	25	80%/-20%	1.80	
2	CL32F106ZOELNN □		10μF	16	80%/-20%	2.00	
3	CL32F226ZPJNNN □		22μF	10	80%/-20%	2.70	
4	CL32F226ZPULNN □		22μF	10	80%/-20%	2.00	
5	CL32F476ZQJNNN □		47μF	6.3	80%/-20%	2.70	
6	CL32F107ZQJNNN □		100μF	6.3	80%/-20%	2.70	

※ □ mark means packaging code. If you want to learn the code or quantity in detail, please see p80.

# Super Small Size Capacitors

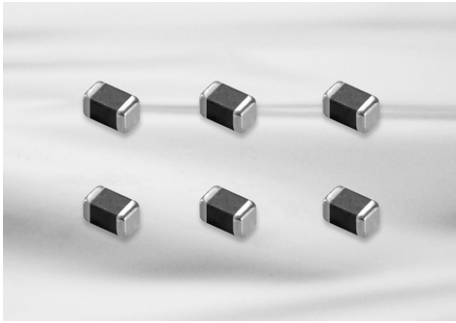

## Feature

- Small chip size
- 03 Series(COG) MLCC shows very low ESR value.
- 02 and 03 Series are suited to only reflow soldering
- 02 and 03 Series are suited to miniature RF module, portable equipment and high frequency circuit

## Application

- VCO, Tuner, RF Module
- MCM Module
- Mobile phone, Wireless LAN, Note PC
  - ※ For using special purpose like Military, Medical, Aviation, Automobile device should be following a special specification.

## Structure and Dimensions

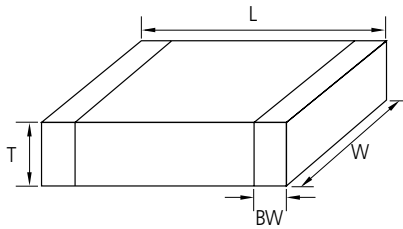

Code	EIA Code	Dimension(mm)			
		L	W	T	BW
02	01005	0.4±0.02	0.2±0.02	0.2±0.02	0.07~0.14
03	0201	0.6±0.03	0.3±0.03	0.3±0.03	0.15±0.05

Part Numbering System

General Capacitors

High Capacitance Capacitors

Super Small Size Capacitors

Medium-High Voltage Capacitors

Array Type Capacitors

Low ESL Capacitors

Reliability Test Condition

Premium Capacitors for Automotive Applications

Packaging Specification

Application Manual for Surface Mounting



### Super Small Size Capacitance Table (C0G)

Size(mm)	Tmax (mm)	Vr(V)	Capacitance (pF)									
			0.5	1	10	22	47	100	220	330		
C0G	01005(0402)	6.3										
		16										
	0201(0603)	25										
		50										

### Super Small Size Capacitance Table (X5R, X7R, Y5V)

TC	Size (mm)	Vr(V)	Capacitance (uF)								
			0.1	0.22	0.47	1	2.2	4.7	10	22	
C0G	01005(0402)	6.3									
		0201(0603)	4	X5R or X6S							
	6.3										
	10										
	16										
	25										
X7R	01005(0402)	10									
		0201(0603)	10								
	16										
Y5V	0201(0603)	6.3									

**Product Lineup (Super Small Size Capacitors -C0G)**

	Part Number	Size L×W (mm)	Capacitance	Rated Voltage (Vdc)	Capacitance Tolerance	Thickness Max. (mm)	
1	CL02C0R5C02ANN □	0.40×0.20	0.5 pF	16	±0.25 pF	0.22	
2	CL02C010C02ANN □		1.0 pF	16	±0.25 pF	0.22	
3	CL02C1R2C02ANN □		1.2 pF	16	±0.25 pF	0.22	
4	CL02C1R5C02ANN □		1.5 pF	16	±0.25 pF	0.22	
5	CL02C1R8C02ANN □		1.8 pF	16	±0.25 pF	0.22	
6	CL02C020C02ANN □		2.0 pF	16	±0.25 pF	0.22	
7	CL02C2R2C02ANN □		2.2 pF	16	±0.25 pF	0.22	
8	CL02C2R7C02ANN □		2.7 pF	16	±0.25 pF	0.22	
9	CL02C030C02ANN □		3.0 pF	16	±0.25 pF	0.22	
10	CL02C3R3C02ANN □		3.3 pF	16	±0.25 pF	0.22	
11	CL02C3R9C02ANN □		3.9 pF	16	±0.25 pF	0.22	
12	CL02C4R7C02ANN □		4.7 pF	16	±0.25 pF	0.22	
13	CL02C5R6D02ANN □		5.6 pF	16	±0.5 pF	0.22	
14	CL02C6R8D02ANN □		6.8 pF	16	±0.5 pF	0.22	
15	CL02C8R2D02ANN □		8.2 pF	16	±0.5 pF	0.22	
16	CL02C090D02ANN □		9.0 pF	16	±0.5 pF	0.22	
17	CL02C100J02ANN □		10 pF	16	±5%	0.22	
18	CL02C150J02ANN □		15 pF	16	±5%	0.22	
19	CL02C180J02ANN □		18 pF	16	±5%	0.22	
20	CL02C220J02ANN □		22 pF	16	±5%	0.22	
21	CL02C270J02ANN □		27 pF	16	±5%	0.22	
22	CL02C330J02ANN □		33 pF	16	±5%	0.22	
23	CL02C390J02ANN □		39 pF	16	±5%	0.22	
24	CL02C470J02ANN □		47 pF	16	±5%	0.22	
25	CL02C560JQ2ANN □		56 pF	6.3	±5%	0.22	
26	CL02C680JQ2ANN □		68 pF	6.3	±5%	0.22	
27	CL02C820JQ2ANN □		82 pF	6.3	±5%	0.22	
28	CL02C101JQ2ANN □		100 pF	6.3	±5%	0.22	
1	CL03C0R5CA3GNN □	0.60×0.30	0.5 pF	25	±0.25 pF	0.33	High-Q
2	CL03C010CA3GNN □		1.0 pF	25	±0.25 pF	0.33	High-Q
3	CL03C1R2CA3GNN □		1.2 pF	25	±0.25 pF	0.33	High-Q
4	CL03C1R5CA3GNN □		1.5 pF	25	±0.25 pF	0.33	High-Q
5	CL03C1R8CA3GNN □		1.8 pF	25	±0.25 pF	0.33	High-Q
6	CL03C020CA3GNN □		2.0 pF	25	±0.25 pF	0.33	High-Q
7	CL03C2R2CA3GNN □		2.2 pF	25	±0.25 pF	0.33	High-Q
8	CL03C2R7CA3GNN □		2.7 pF	25	±0.25 pF	0.33	High-Q
9	CL03C030CA3GNN □		3.0 pF	25	±0.25 pF	0.33	High-Q
10	CL03C3R3CA3GNN □		3.3 pF	25	±0.25 pF	0.33	High-Q
11	CL03C3R9CA3GNN □		3.9 pF	25	±0.25 pF	0.33	High-Q
12	CL03C4R7CA3GNN □		4.7 pF	25	±0.25 pF	0.33	High-Q
13	CL03C5R6DA3GNN □		5.6 pF	25	±0.5 pF	0.33	High-Q
14	CL03C6R8DA3GNN □		6.8 pF	25	±0.5 pF	0.33	High-Q
15	CL03C8R2DA3GNN □		8.2 pF	25	±0.5 pF	0.33	High-Q
16	CL03C090DA3GNN □		9.0 pF	25	±0.5 pF	0.33	High-Q
17	CL03C100JA3GNN □		10 pF	25	±5%	0.33	High-Q
18	CL03C150JA3GNN □		15 pF	25	±5%	0.33	High-Q
19	CL03C180JA3GNN □		18 pF	25	±5%	0.33	High-Q
20	CL03C220JA3GNN □		22 pF	25	±5%	0.33	High-Q
21	CL03C270JA3GNN □		27 pF	25	±5%	0.33	High-Q
22	CL03C330JA3GNN □		33 pF	25	±5%	0.33	High-Q
23	CL03C390JA3ANN □		39 pF	25	±5%	0.33	
24	CL03C470JA3ANN □		47 pF	25	±5%	0.33	
25	CL03C101JA3ANN □		100 pF	25	±5%	0.33	

Part Numbering System

General Capacitors

High Capacitance Capacitors

Super Small Size Capacitors

Medium-High Voltage Capacitors

Array Type Capacitors

Low ESL Capacitors

Reliability Test Condition

Premium Capacitors for Automotive Applications

Packaging Specification

Application Manual for Surface Mounting

※ □ mark means packaging code. If you want to learn the code or quantity in detail, please see p80.



## Product Lineup (Super Small Size Capacitors -X7R)

	Part Number	Size L×W (mm)	Capacitance	Rated Voltage (Vdc)	Capacitance Tolerance	Thickness Max. (mm)
1	CL02B101KP2NNN □	0.40×0.20	100pF	10	±10%	0.22
2	CL02B151KP2NNN □		150pF	10	±10%	0.22
3	CL02B221KP2NNN □		220pF	10	±10%	0.22
4	CL02B331KP2NNN □		330pF	10	±10%	0.22
5	CL02B471KP2NNN □		470pF	10	±10%	0.22
6	CL02B681KP2NNN □		680pF	10	±10%	0.22
7	CL02B102KP2NNN □		1.0nF	10	±10%	0.22
1	CL03B331KO3NNN □	0.60×0.30	330pF	16	±10%	0.33
2	CL03B102KO3NNN □		1nF	16	±10%	0.33
3	CL03B472KQ3NNN □		4.7nF	6.3	±10%	0.33
4	CL03B103KP3NNN □		10nF	10	±10%	0.33

## Product Lineup (Super Small Size Capacitors -X5R)

	Part Number	Size L×W (mm)	Capacitance	Rated Voltage (Vdc)	Capacitance Tolerance	Thickness Max. (mm)
1	CL02A151KQ2NNN □	0.40×0.20	150pF	6.3	±10%	0.22
2	CL02A221KQ2NNN □		220pF	6.3	±10%	0.22
3	CL02A331KQ2NNN □		330pF	6.3	±10%	0.22
4	CL02A471KQ2NNN □		470pF	6.3	±10%	0.22
5	CL02A681KQ2NNN □		680pF	6.3	±10%	0.22
6	CL02A102KQ2NNN □		1nF	6.3	±10%	0.22
7	CL02A152KQ2NNN □		1.5nF	6.3	±10%	0.22
8	CL02A222KQ2NNN □		2.2nF	6.3	±10%	0.22
9	CL02A332KQ2NNN □		3.2nF	6.3	±10%	0.22
10	CL02A472KQ2NNN □		4.7nF	6.3	±10%	0.22
11	CL02A682KQ2NNN □		6.8nF	6.3	±10%	0.22
12	CL02A103KQ2NNN □		10nF	6.3	±10%	0.22
13	CL02A104KQ2NNN □		100nF	6.3	±10%	0.22
1	CL03A103KP3NNN □	0.60×0.30	10nF	10	±10%	0.33
2	CL03A223KQ3NNN □		22nF	6.3	±10%	0.33
3	CL03A473KQ3NNN □		47nF	6.3	±10%	0.33
4	CL03A104MA3NNN □		100nF	25	±20%	0.33
5	CL03A104KO3NNN □		100nF	16	±10%	0.33
6	CL03A104KP3NNN □		100nF	10	±10%	0.33
7	CL03A104KQ3NNN □		100nF	6.3	±10%	0.33
8	CL03A224KQ3NNN □		220nF	6.3	±10%	0.33
9	CL03A224KP3NNN □		200nF	10	±10%	0.33
10	CL03A105MQ3CSN □		1μF	6.3	±20%	0.35

※ □ mark means packaging code. If you want to learn the code or quantity in detail, please see p80.

# Medium-High Voltage Capacitors

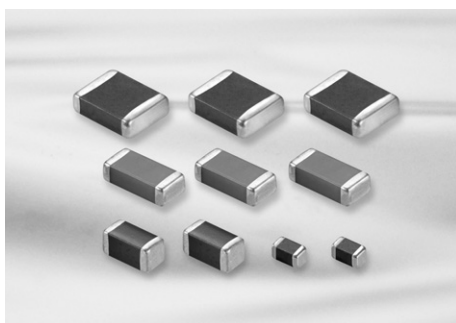

## Feature

- Highly reliable performance
- Operating at high voltage level
- Wide voltage level: from 100V to 3000V
- High withstanding voltage
- Tape & reel surface mount assembly

## Application

- Switching Power Circuit(SMPS)
  - Lighting Ballast, LCD back lighting inverter
  - DC-DC converter input filter, snubber circuit
  - Phone, Fax, Modem
  - Network(IEEE802.3)
- ※ For using special purpose like Military, Medical, Aviation, Automobile device should be following a special specification.

## Structure and Dimensions

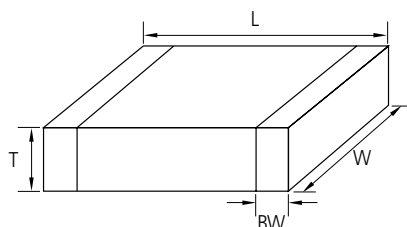

Code	EIA Code	Dimension(mm)			
		L	W	T	BW
10	0603	1.6±0.1	0.8±0.1	0.8±0.1	0.3±0.2
21	0805	2.0±0.1	1.25±0.1	1.25±0.1	0.5+0.2/-0.3
31	1206	3.2±0.2	1.6±0.2	1.6±0.2	0.5±0.3
		3.2±0.15	1.6±0.15	0.85±0.15	
32	1210	3.2±0.3	2.5±0.2	2.5±0.2	0.6±0.3
42	1808	4.5±0.4	2.0±0.2	2.0±0.2	0.8±0.3
43	1812	4.5±0.4	3.2±0.3	2.5±0.2	0.8±0.3
55	2220	5.7±0.4	5.0±0.4	2.5±0.2	1.0±0.3

Part Numbering System

General Capacitors

High Capacitance Capacitors

Super Small Size Capacitors

Medium-High Voltage Capacitors

Array Type Capacitors

Low ESL Capacitors

Reliability Test Condition

Premium Capacitors for Automotive Applications

Packaging Specification

Application Manual for Surface Mounting



**Medium-High Voltage Capacitors Table (C0G)**

Vr	Size(mm)	Capacitance																									
		(pF)						(nF)																			
		330	390	470	560	680	820	1	1.2	1.5	1.8	2.2	2.7	3.3	3.9	4.7	5.6	6.8	8.2	10	12	15	18	22	27	33	47
100V	0603(1608)	■																									
	0805(2012)	■																									
	1206(3216)	■																									
	1210(3225)							■																			
	1812(4532)													■													
	2220(5750)																■										
200V	0603(1608)	■																									
	0805(2012)	■																									
	1206(3216)	■																									
	1210(3225)							■																			
	1812(4532)													■													
	2220(5750)																■										
250V	0603(1608)	■																									
	0805(2012)	■																									
	1206(3216)	■																									
	1210(3225)							■																			
	1812(4532)													■													
	2220(5750)																■										
500V	1206(3216)	■																									
	1210(3225)	■						■																			
	1812(4532)	■																									
	2220(5750)													■													
630V	1206(3216)	■																									
	1210(3225)	■						■																			
	1812(4532)	■																									
	2220(5750)													■													





### Medium-High Voltage Capacitors Table (X7R)

Size(mm)	Vr(V)	Capacitance (nF)															
		4.7	10	15	22	33	47	68	100	150	220	330	470	680	1000	1500	2200
100V	0603(1608)	■															
	0805(2012)	■															
	1206(3216)	■															
	1210(3225)	■															
	1812(4532)								■								
	2220(5750)													■			
200V	0805(2012)	■															
	1206(3216)	■															
	1210(3225)							■									
	1812(4532)						■										
	2220(5750)											■					
250V	0805(2012)	■															
	1206(3216)					■											
	1210(3225)								■								
	1812(4532)									■							
	2220(5750)											■					
350V	1206(3216)	■		(Tmax =1.0)		(Tmax =1.25)		(Tmax =1.8)									
500V	1206(3216)	■															
	1210(3225)	■															
	1812(4532)	■			■												
	2220(5750)										■						
630V	1206(3216)	■															
	1210(3225)	■															
	1812(4532)	■			■												
	2220(5750)										■						

## Medium-High Voltage Capacitors Table (X7R)

Size(mm)	Vr(V)	Capacitance (nF)															
		1	1.5	2.2	3.3	4.7	6.8	10	15	22	33	47	68	100	150	220	330
1K	1206(3216)	■															
	1210(3225)	■															
	1812(4532)	■															
	2220(5750)												■				
2KV	1206(3216)	■															
	1210(3225)	■															
	1808(4520)	■															
	1812(4532)	■															
	2220(5750)	■															
3KV	1808(4520)	■															

Part Numbering System

General Capacitors

High Capacitance Capacitors

Super Small Size Capacitors

**Medium-High Voltage Capacitors**

Array Type Capacitors

Low ESL Capacitors

Reliability Test Condition

Premium Capacitors for Automotive Applications

Packaging Specification

Application Manual for Surface Mounting



**Product Lineup (Medium-High Voltage Capacitors-C0G)**

	Part Number	Size L×W (mm)	Capacitance	Rated Voltage (Vdc)	Capacitance Tolerance	Thickness Max. (mm)
1	CL10C100JC8NNN □	1.60×0.80	10pF	100	±5%	0.90
2	CL10C150JC8NNN □		15pF	100	±5%	0.90
3	CL10C330JC8NNN □		33pF	100	±5%	0.90
4	CL10C390JC8NNN □		39pF	100	±5%	0.90
5	CL10C470JC8NNN □		47pF	100	±5%	0.90
6	CL10C560JC8NNN □		560pF	100	±5%	0.90
7	CL10C101JC8NNN □		100pF	100	±5%	0.90
8	CL10C121JC8NNN □		120pF	100	±5%	0.90
9	CL10C151JC8NNN □		150pF	100	±5%	0.90
10	CL10C331JC8NNN □		330pF	100	±5%	0.90
11	CL10C331JD8NNN □		330pF	200	±5%	0.90
12	CL10C331JE8NNN □		330pF	250	±5%	0.90
13	CL10C391JD8NNN □		390pF	200	±5%	0.90
14	CL10C391JE8NNN □		390pF	250	±5%	0.90
15	CL10C471JC8NNN □		470pF	100	±5%	0.90
16	CL10C471JD8NNN □		470pF	200	±5%	0.90
17	CL10C471JE8NNN □		470pF	250	±5%	0.90
18	CL10C561JD8NNN □		560pF	200	±5%	0.90
19	CL10C561JE8NNN □		560pF	250	±5%	0.90
20	CL10C681JC8NNN □		680pF	100	±5%	0.90
21	CL10C681JD8NNN □		680pF	200	±5%	0.90
22	CL10C681JE8NNN □		680pF	250	±5%	0.90
23	CL10C821JC8NNN □		820pF	100	±5%	0.90
24	CL10C102JC8NNN □		1nF	100	±5%	0.90
25	CL10C122JC8NNN □		1.2nF	100	±5%	0.90
1	CL21C100JCANNN □	2.00×1.25	10pF	100	±5%	0.75
2	CL21C120JCANNN □		12pF	100	±5%	0.75
3	CL21C150JDCNNN □		15pF	200	±5%	0.95
4	CL21C150JCANNN □		15pF	100	±5%	0.75
5	CL21C180JDCNNN □		18pF	200	±5%	0.95
6	CL21C180JCANNN □		18pF	100	±5%	0.75
7	CL21C220JCANNN □		22pF	100	±5%	0.75
8	CL21C270JCANNN □		27pF	100	±5%	0.75
9	CL21C330JCANNN □		33pF	100	±5%	0.75
10	CL21C330JDCNNN □		33pF	200	±5%	0.95
11	CL21C390JDCNNN □		39pF	200	±5%	0.95
12	CL21C470JCANNN □		47pF	100	±5%	0.75
13	CL21C470JDCNNN □		47pF	200	±5%	0.95
14	CL21C560JCCNNN □		56pF	100	±5%	0.95
15	CL21C560JDCNNN □		56pF	200	±5%	0.95
16	CL21C680JCANNN □		68pF	100	±5%	0.75
17	CL21C680JDCNNN □		68pF	200	±5%	0.95
18	CL21C820JCCNNN □		82pF	100	±5%	0.95
19	CL21C101JDCNNN □		100pF	200	±5%	0.95
20	CL21C101J ECNNN □		100pF	250	±5%	0.95
21	CL21C101JCANNN □		100pF	100	±5%	0.75
22	CL21C121JDCNNN □		120pF	200	±5%	0.95
23	CL21C151JCANNN □		150pF	100	±5%	0.75
24	CL21C221JCANNN □		220pF	100	±5%	0.75
25	CL21C221JDCNNN □		220pF	200	±5%	0.95

※ □ mark means packaging code. If you want to learn the code or quantity in detail, please see p80.

Product Lineup (Medium-High Voltage Capacitors-C0G)

	Part Number	Size L×W (mm)	Capacitance	Rated Voltage (Vdc)	Capacitance Tolerance	Thickness Max. (mm)
26	CL21C331JCANN □	2.00×1.25	330pF	100	±5%	0.75
27	CL21C471JCCNN □		470pF	100	±5%	0.95
28	CL21C561JCCNN □		560pF	100	±5%	0.95
29	CL21C681JCCNN □		680pF	100	±5%	0.95
30	CL21C102JCFNN □		1nF	100	±5%	1.35
31	CL21C102JDFNN □		1nF	200	±5%	1.35
32	CL21C272JDFNN □		2.7nF	200	±5%	1.35
33	CL21C272JEFNN □		2.7nF	250	±5%	1.35
34	CL21C472JCFNN □		4.7nF	100	±5%	1.35
1	CL31C150JGFNN □		3.20×1.60	15pF	500	±5%
2	CL31C180JGFNN □	18pF		500	±5%	1.40
3	CL31C220JGFNN □	22pF		500	±5%	1.40
4	CL31C220JHNN □	22pF		2000	±5%	1.80
5	CL31C270JGFNN □	27pF		500	±5%	1.40
6	CL31C330JGFNN □	33pF		500	±5%	1.40
7	CL31C390JGFNN □	39pF		500	±5%	1.40
8	CL31C470JHFNN □	47pF		630	±5%	1.40
9	CL31C470JGFNN □	47pF		500	±5%	1.40
10	CL31C470JHNN □	47pF		2000	±5%	1.80
11	CL31C560JGFNN □	56pF		500	±5%	1.40
12	CL31C680JCCNN □	68pF		100	±5%	1.00
13	CL31C680JHFNN □	68pF		630	±5%	1.40
14	CL31C680JGFNN □	68pF		500	±5%	1.40
15	CL31C680JIFNN □	68pF		1000	±5%	1.40
16	CL31C820JGFNC □	82pF		500	±5%	1.40
17	CL31C101JGFNN □	100pF		500	±5%	1.40
18	CL31C101JHFNN □	100pF		630	±5%	1.40
19	CL31C101JIFNN □	100pF		1000	±5%	1.40
20	CL31C101JHNN □	100pF		2000	±5%	1.80
21	CL31C121JGFNN □	120pF		500	±5%	1.40
22	CL31C151JGFNN □	150pF		500	±5%	1.40
23	CL31C181JGFNN □	180pF		500	±5%	1.40
24	CL31C221JGFNN □	220pF		500	±5%	1.40
25	CL31C271JGFNN □	270pF		500	±5%	1.40
26	CL31C271JCCNN □	270pF		100	±5%	1.00
27	CL31C331JGFNN □	330pF		500	±5%	1.40
28	CL31C331JHNN □	330pF		1000	±5%	1.80
29	CL31C391JCCNN □	390pF		100	±5%	1.00
30	CL31C471JGFNN □	470pF		500	±5%	1.40
31	CL31C561JCCNN □	560pF		100	±5%	1.00
32	CL31C561JGFNN □	560pF		500	±5%	1.40
33	CL31C681JGFNN □	680pF		500	±5%	1.80
34	CL31C102JCCNN □	1nF		100	±5%	1.00
35	CL31C102JGHNN □	1nF		500	±5%	1.80
36	CL31C152JCCNN □	1.5nF		100	±5%	1.00
37	CL31C222JCCNN □	2.2nF		100	±5%	1.00
38	CL31C332JGHNN □	3.3nF		500	±5%	1.80
39	CL31C332JHNN □	3.3nF		630	±5%	1.80
40	CL31C392JCHNN □	3.9nF		100	±5%	1.80
41	CL31C822JDHNN □	8.2nF		200	±5%	1.80

※ □ mark means packaging code. If you want to learn the code or quantity in detail, please see p80.

- Part Numbering System
- General Capacitors
- High Capacitance Capacitors
- Super Small Size Capacitors
- Medium-High Voltage Capacitors
- Array Type Capacitors
- Low ESL Capacitors
- Reliability Test Condition
- Premium Capacitors for Automotive Applications
- Packaging Specification
- Application Manual for Surface Mounting





**Product Lineup (Medium-High Voltage Capacitors-C0G)**

	Part Number	Size L×W (mm)	Capacitance	Rated Voltage (Vdc)	Capacitance Tolerance	Thickness Max. (mm)
42	CL31C822JEHNNN □	3.20×1.60	8.2nF	250	±5%	1.80
43	CL31C183JCHNNN □		18nF	100	±5%	1.80
1	CL32C101JJFNNN □	3.20×2.50	100pF	2000	±5%	1.45
2	CL32C471JJJNNN □		470pF	2000	±5%	2.70
3	CL32C821JIIJNNN □		820pF	1000	±5%	2.70
4	CL32C103JGJNNN □		10nF	500	±5%	2.70
5	CL32C103JHJNNN □		10nF	630	±5%	2.70
6	CL32C273JDJNNN □		27nF	200	±5%	2.70
7	CL32C273JEJNNN □		27nF	250	±5%	2.70
8	CL32C563JCJNNN □		56nF	100	±5%	2.70
1	CL42C100JKFNNN □	4.50×2.00	10pF	3000	±5%	1.45
2	CL42C151JKINNN □		150pF	3000	±5%	2.20
3	CL42C221JJHNNN □		220pF	2000	±5%	1.80
1	CL43C391JKJNNN □	4.50×3.20	390pF	2000	±5%	2.70
2	CL43C102JIIHNNN □		1.0nF	1000	±5%	1.80
3	CL43C122JIIJNNN □		1.2nF	1000	±5%	2.20
4	CL43C182JIIJNNN □		1.8nF	1000	±5%	2.70
5	CL43C182JJJNNN □		1.8nF	2000	±5%	2.70
6	CL43C223JGJNNN □		22nF	500	±5%	2.70
7	CL43C223JHJNNN □		22nF	630	±5%	2.70
8	CL43C473JDJNNN □		47nF	200	±5%	2.70
9	CL43C473JEJNNN □		47nF	250	±5%	2.70
10	CL43C563JCJNNN □		56nF	100	±5%	2.70
1	CL55C102JJJNNN □	5.70×5.00	1nF	2000	±5%	2.70
2	CL55C102JKJNNN □		1nF	3000	±5%	2.70
3	CL55C362JIIJNNN □		3.3nF	1000	±5%	2.70
4	CL55C223JGJNNN □		22nF	500	±5%	2.70
5	CL55C223JHJNNN □		22nF	630	±5%	2.70
6	CL55C473JDJNNN □		47nF	200	±5%	2.70
7	CL55C473JEJNNN □		47nF	250	±5%	2.70
8	CL55C683JCJNNN □		68nF	100	±5%	2.70

※ □ mark means packaging code. If you want to learn the code or quantity in detail, please see p80.

**Product Lineup (Medium-High Voltage Capacitors-X7R)**

	Part Number	Size L×W (mm)	Capacitance	Rated Voltage (Vdc)	Capacitance Tolerance	Thickness Max. (mm)
1	CL10B102KC8NNN □	1.60×0.80	1nF	100	±10%	0.90
2	CL10B472KC8NNN □		4.7nF	100	±10%	0.90
3	CL10B103KC8NNN □		10nF	100	±10%	0.90
1	CL21B221KDCNNN □	2.00×1.25	220pF	200	±10%	0.95
2	CL21B221KCANNN □		220pF	100	±10%	0.75
3	CL21B331KDCNNN □		330pF	200	±10%	0.95
4	CL21B471KCANNN □		470pF	100	±10%	0.75
5	CL21B102KDCNNN □		1nF	200	±10%	0.95
6	CL21B102KCANNN □		1nF	100	±10%	0.75
7	CL21B222KDCNNN □		2.2nF	200	±10%	0.95
8	CL21B222KCANNN □		2.2nF	100	±10%	0.75
9	CL21B332KCANNN □		3.3nF	100	±10%	0.75
10	CL21B472KDCNNN □		4.7nF	200	±10%	0.95
11	CL21B472KCANNN □		4.7nF	100	±10%	0.75
12	CL21B682KCANNN □		6.8nF	100	±10%	0.75
13	CL21B103KDCNNN □		10nF	200	±10%	0.95
14	CL21B103KCANNN □		10nF	100	±10%	0.75
15	CL21B153KEFNNN □		15nF	250	±10%	1.35
16	CL21B153KDFNNN □		15nF	200	±10%	1.35
17	CL21B153KCCNNN □		15nF	100	±10%	0.95
18	CL21B223KCFNNN □		22nF	100	±10%	1.35
19	CL21B473KCFNNN □		47nF	100	±10%	1.35
20	CL21B683KCFNNN □		68nF	100	±10%	1.35
21	CL21B104KCFNNN □		100nF	100	±10%	1.35
22	CL21B154KCFNNN □		150nF	100	±10%	1.35
23	CL21B224KCFNNN □		220nF	100	±10%	1.35
1	CL31B221KGFNNN □	3.20×1.60	220pF	500	±10%	1.40
2	CL31B471KGFNNN □		470pF	500	±10%	1.40
3	CL31B471KDCNNN □		470pF	200	±10%	1.00
4	CL31B102KJHNNN □		1nF	2000	±10%	1.80
5	CL31B102KIFNNN □		1nF	1000	±10%	1.40
6	CL31B102KGFNNN □		1nF	500	±10%	1.40
7	CL31B102KHFNNN □		1nF	630	±10%	1.40
8	CL31B152KGFNNN □		1.5nF	500	±10%	1.40
9	CL31B152KJHNNN □		1.5nF	2000	±10%	1.80
10	CL31B222KIFNNN □		2.2nF	1000	±10%	1.40
11	CL31B222KDCNNN □		2.2nF	200	±10%	1.00
12	CL31B222KGFNNN □		2.2nF	500	±10%	1.40
13	CL31B222KJHNNN □		2.2nF	2000	±10%	1.80
14	CL31B332KGFNNN □		3.3nF	500	±10%	1.40
15	CL31B332KIFNNN □		3.3nF	1000	±10%	1.40
16	CL31B472KGFNNN □		4.7nF	500	±10%	1.40

※ □ mark means packaging code. If you want to learn the code or quantity in detail, please see p80.

- Part Numbering System
- General Capacitors
- High Capacitance Capacitors
- Super Small Size Capacitors
- Medium-High Voltage Capacitors
- Array Type Capacitors
- Low ESL Capacitors
- Reliability Test Condition
- Premium Capacitors for Automotive Applications
- Packaging Specification
- Application Manual for Surface Mounting



Product Lineup (Medium-High Voltage Capacitors-X7R)

	Part Number	Size L×W (mm)	Capacitance	Rated Voltage (Vdc)	Capacitance Tolerance	Thickness Max. (mm)	
17	CL31B472KDCNNN □	3.20×1.60	4.7nF	200	±10%	1.00	
18	CL31B682KGFNNN □		6.8nF	500	±10%	1.40	
19	CL31B103KHFNNN □		10nF	630	±10%	1.40	
20	CL31B103KGFNNN □		10nF	500	±10%	1.40	
21	CL31B103KFCSNN □		10nF	350	±10%	1.00	
22	CL31B153KDCNNN □		15nF	200	±10%	1.00	
23	CL31B153KFCSNN □		15nF	350	±10%	1.00	
24	CL31B153KCCNNN □		15nF	100	±10%	1.00	
25	CL31B153KGFNNN □		15nF	500	±10%	1.40	
26	CL31B153KHFNNN □		15nF	630	±10%	1.40	
27	CL31B223KDCNNN □		22nF	200	±10%	1.00	
28	CL31B223KCCNNN □		22nF	100	±10%	1.00	
29	CL31B223KFCSNN □		22nF	350	±10%	1.00	
30	CL31B223KGHNNN □		22nF	500	±10%	1.80	
31	CL31B223KHHNNN □		22nF	630	±10%	1.80	
32	CL31B333KDFNNN □		33nF	200	±10%	1.40	
33	CL31B333KFESNN □		33nF	350	±10%	1.25	
34	CL31B333KCCNNN □		33nF	100	±10%	1.00	
35	CL31B333KGHNNN □		33nF	500	±10%	1.80	
36	CL31B333KHHNNN □		33nF	630	±10%	1.80	
37	CL31B473KDFNNN □		47nF	200	±10%	1.40	
38	CL31B473KFHSNN □		47nF	350	±10%	1.80	
39	CL31B473KCCNNN □		47nF	100	±10%	1.00	
40	CL31B473KEHNNN □		47nF	250	±10%	1.80	
41	CL31B683KEHNNN □		68nF	250	±10%	1.80	
42	CL31B104KDHHNN □		100nF	200	±10%	1.80	
43	CL31B104KCFNNN □		100nF	100	±10%	1.40	
44	CL31B104KEHNNN □		100nF	250	±10%	1.80	
45	CL31B154KCHNNN □		150nF	100	±10%	1.80	
46	CL31B105KCHNNN □		1μF	100	±10%	1.80	
47	CL31B155KCHNNN □		1.5μF	100	±10%	1.80	
48	CL31B225KCHNNN □		2.2μF	100	±10%	1.80	
1	CL32B102KJFNNN □		3.20×2.50	1nF	2000	±10%	1.45
2	CL32B472KHFNNN □			4.7nF	630	±10%	1.45
3	CL32B472KIFNNN □			4.7nF	1000	±10%	1.45
4	CL32B682KIFNNN □			6.8nF	1000	±10%	1.45
5	CL32B103KCFNNN □			10nF	100	±10%	1.45
6	CL32B153KGFNNN □			15nF	500	±10%	1.45
7	CL32B223KGFNNN □	22nF		500	±10%	1.45	
8	CL32B333KHHNNN □	33nF		630	±10%	1.80	
9	CL32B333KGHNNN □	33nF		500	±10%	1.80	
10	CL32B473KHHNNN □	47nF		630	±10%	1.80	

※ □ mark means packaging code. If you want to learn the code or quantity in detail, please see p80.

**Product Lineup (Medium-High Voltage Capacitors-X7R)**

	Part Number	Size L×W (mm)	Capacitance	Rated Voltage (Vdc)	Capacitance Tolerance	Thickness Max. (mm)
11	CL32B473KDHNNN □	3.20×2.50	47nF	200	±10%	1.80
12	CL32B473KGNHNN □		47nF	500	±10%	1.80
13	CL32B683KDINNN □		68nF	200	±10%	2.20
14	CL32B104KE JNNN □		100nF	250	±10%	2.70
15	CL32B104KDINNN □		100nF	200	±10%	2.20
16	CL32B154KCFNNN □		150nF	100	±10%	1.45
17	CL32B154KDJNNN □		150nF	200	±10%	2.70
18	CL32B154KEJNNN □		150nF	250	±10%	2.70
19	CL32B224KCHNNN □		220nF	100	±10%	1.80
20	CL32B224KDJNNN □		220nF	200	±10%	2.70
21	CL32B224KEJNNN □		220nF	250	±10%	2.70
22	CL32B334KCHNNN □		330nF	100	±10%	1.80
23	CL32B474KCINNN □		470nF	100	±10%	2.20
24	CL32B105KJNNN □		1μF	100	±10%	2.70
25	CL32B155KCHNNN □		1.5μF	100	±10%	1.80
26	CL32B225KJNNN □		2.2μF	100	±10%	2.70
1	CL43B102KJFNNN □	4.50×3.20	1nF	2000	±10%	1.45
2	CL43B152KJFNNN □		1.5nF	2000	±10%	1.45
3	CL43B222KJFNNN □		2.2nF	1000	±10%	1.45
4	CL43B222KJFNNN □		2.2nF	2000	±10%	1.45
5	CL43B332KJFNNN □		3.3nF	2000	±10%	1.45
6	CL43B103KJFNNN □		10nF	1000	±10%	1.45
7	CL43B333KIJNNN □		33nF	1000	±10%	2.70
8	CL43B473KGFNNN □		47nF	500	±10%	1.45
9	CL43B473KHFNNN □		47nF	630	±10%	1.45
10	CL43B473KIJNNN □		47nF	1000	±10%	2.70
11	CL43B104KGINNN □		100nF	500	±10%	2.20
12	CL43B104KDFNNN □		100nF	200	±10%	1.45
13	CL43B104KHINNN □		100nF	630	±10%	2.20
14	CL43B224KCFNNN □		220nF	100	±10%	1.45
15	CL43B334KCFNNN □		330nF	100	±10%	1.45
16	CL43B474KEJNNN □		470nF	250	±10%	2.70
17	CL43B474KCHNNN □		470nF	100	±10%	1.80
18	CL43B474KDJNNN □		470nF	200	±10%	2.70
19	CL43B105KJNNN □		1μF	100	±10%	2.70
1	CL55B103KJHNNN □	5.70×5.00	10nF	2000	±10%	1.80
2	CL55B473KIINNN □		47nF	1000	±10%	2.20
3	CL55B224KGJNNN □		220nF	500	±10%	2.70
4	CL55B224KHJNNN □		220nF	630	±10%	2.70
5	CL55B105KCHNNN □		1μF	100	±10%	1.80
6	CL55B105KDJNNN □		1μF	200	±10%	2.70
7	CL55B105KEJNNN □		1μF	250	±10%	2.70
8	CL55B475KJNNN □		4.7uF	100	±10%	2.70

※ □mark means packaging code. If you want to learn the code or quantity in detail, please see p80.

- Part Numbering System
- General Capacitors
- High Capacitance Capacitors
- Super Small Size Capacitors
- Medium-High Voltage Capacitors
- Array Type Capacitors
- Low ESL Capacitors
- Reliability Test Condition
- Premium Capacitors for Automotive Applications
- Packaging Specification
- Application Manual for Surface Mounting

# Array Type Capacitors

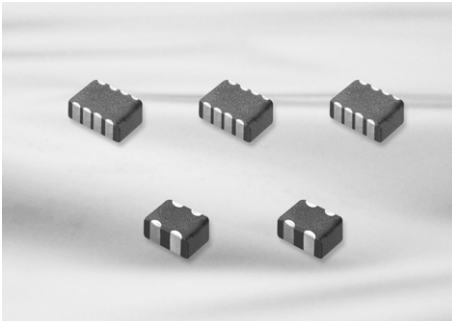

## Feature

- Reduction in required space(more than 50%)
- Reduction in cost and time for replacement of PCB
- Reduction in amount of solder joints
- Easier PCB design
- Reduced waste from tape and reel packaging process
- It protect EMI bypassing digital signal line nose

## Application

- A bypass for digital and analog signal line noise generated by telecommunication equipment and other common electronic circuits
- ※ For using special purpose like Military, Medical, Aviation, Automobile device should be following a special specification.

## Structure and Dimensions

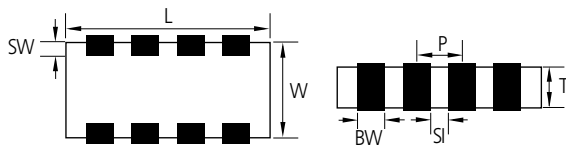

Code	EIA Code	Dimension(mm)					
		L	W	T	BW	SW	P
A	0504	$1.37 \pm 0.15$	$1.0 \pm 0.15$	$0.35 \pm 0.05$	$0.36 \pm 0.1$	$0.2 \pm 0.1$	$0.64 \pm 0.1$
	$0.50 \pm 0.05$						
	$0.60 \pm 0.06$						
	$0.80 \pm 0.08$						
A	0805	$2.0 \pm 0.15$	$1.25 \pm 0.15$	$0.85 \pm 0.1$	$0.5 \pm 0.2$	$0.25 \pm 0.15$	$1.0 \pm 0.1$
B	0805	$2.0 \pm 0.15$	$1.25 \pm 0.15$	$0.85 \pm 0.1$	$0.25 \pm 0.1$	$0.25 \pm 0.15$	$0.5 \pm 0.1$
B	1206	$3.2 \pm 0.15$	$1.6 \pm 0.15$	$0.85 \pm 0.15$	$0.4 \pm 0.2$	$0.3 \pm 0.15$	$0.8 \pm 0.2$

## Structure and Control Code

### ▪ A : ARRAY(2-element)

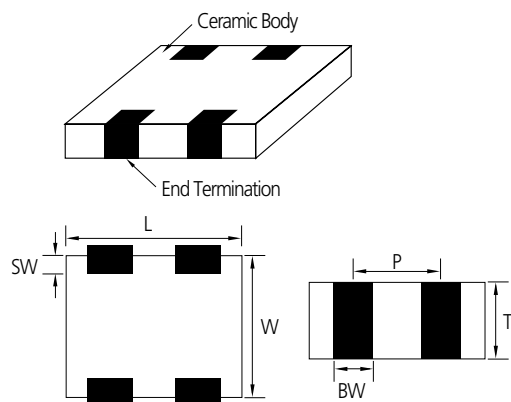

### ▪ B : ARRAY(4-element)

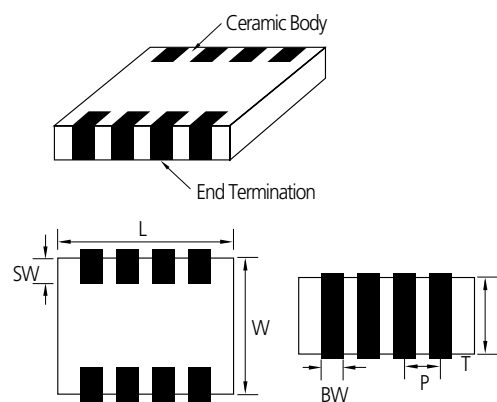

Array Type Capacitors Table (C0G, X5R, X7R, Y5V)

TC	Size(mm)	Type	Vr(V)	Tmax (mm)	Capacitance (pF)					
					10	22	27	47	100	470
C0G	0504(1410)	2-element	25		[Bar chart showing capacitance ranges for C0G 0504(1410) 2-element 25V]					
	1206(3216)	4-element	50		[Bar chart showing capacitance ranges for C0G 1206(3216) 4-element 50V]					

TC	Size(mm)	Type	Vr(V)	Tmax (mm)	Capacitance (nF)														
					1	2.2	4.7	10	22	47	100	220	470	1000	2200				
X5R	0302(0906)	2-element	4	0.5	[Bar chart showing capacitance ranges for X5R 0302(0906) 2-element 4V]														
			6.3		[Bar chart showing capacitance ranges for X5R 0302(0906) 2-element 6.3V]														
			10		[Bar chart showing capacitance ranges for X5R 0302(0906) 2-element 10V]														
			6.3		0.88	[Bar chart showing capacitance ranges for X5R 0302(0906) 2-element 6.3V 0.88V]													
					0.66	[Bar chart showing capacitance ranges for X5R 0302(0906) 2-element 6.3V 0.66V]													
					0.55	[Bar chart showing capacitance ranges for X5R 0302(0906) 2-element 6.3V 0.55V]													
	0.4	[Bar chart showing capacitance ranges for X5R 0302(0906) 2-element 6.3V 0.4V]																	
	0504(1410)	2-element	10	0.88	[Bar chart showing capacitance ranges for X5R 0504(1410) 2-element 10V 0.88V]														
				0.66	[Bar chart showing capacitance ranges for X5R 0504(1410) 2-element 10V 0.66V]														
				0.55	[Bar chart showing capacitance ranges for X5R 0504(1410) 2-element 10V 0.55V]														
				0.4	[Bar chart showing capacitance ranges for X5R 0504(1410) 2-element 10V 0.4V]														
			16	0.88	[Bar chart showing capacitance ranges for X5R 0504(1410) 2-element 16V 0.88V]														
				0.66	[Bar chart showing capacitance ranges for X5R 0504(1410) 2-element 16V 0.66V]														
				0.55	[Bar chart showing capacitance ranges for X5R 0504(1410) 2-element 16V 0.55V]														
				0.4	[Bar chart showing capacitance ranges for X5R 0504(1410) 2-element 16V 0.4V]														
	25	0.88	[Bar chart showing capacitance ranges for X5R 0504(1410) 2-element 25V 0.88V]																
		0.66	[Bar chart showing capacitance ranges for X5R 0504(1410) 2-element 25V 0.66V]																
		0.55	[Bar chart showing capacitance ranges for X5R 0504(1410) 2-element 25V 0.55V]																
	0805(2012)	2-element	6.3	[Bar chart showing capacitance ranges for X5R 0805(2012) 2-element 6.3V]															
			10	[Bar chart showing capacitance ranges for X5R 0805(2012) 2-element 10V]															
			16	[Bar chart showing capacitance ranges for X5R 0805(2012) 2-element 16V]															
	X7R	0805(2012)	4-element	10	0.95	[Bar chart showing capacitance ranges for X7R 0805(2012) 4-element 10V]													
				16		[Bar chart showing capacitance ranges for X7R 0805(2012) 4-element 16V]													
		1206(3216)	4-element	16	0.95	[Bar chart showing capacitance ranges for X7R 1206(3216) 4-element 16V]													
25				[Bar chart showing capacitance ranges for X7R 1206(3216) 4-element 25V]															
50				[Bar chart showing capacitance ranges for X7R 1206(3216) 4-element 50V]															
Y5V		1206(3216)	4-element	25	1.0	[Bar chart showing capacitance ranges for Y5V 1206(3216) 4-element 25V]													
	50			[Bar chart showing capacitance ranges for Y5V 1206(3216) 4-element 50V]															

Part Numbering System

General Capacitors

High Capacitance Capacitors

Super Small Size Capacitors

Medium-High Voltage Capacitors

Array Type Capacitors

Low ESL Capacitors

Reliability Test Condition

Premium Capacitors for Automotive Applications

Packaging Specification

Application Manual for Surface Mounting

## Product Lineup (Array Type Capacitors)

	Part Number	Element Type	Size L × W (mm)	Capacitance	Rated Voltage (Vdc)	Capacitance Tolerance	Thickness Max. (mm)
1	CL14C270KA6NAN □	2-Array	1.40 × 1.00	27pF	25	±10%	0.66
1	CL31C100 JBCNBN □	4-Array	3.20 × 1.60	10pF	50	±5%	1.0
2	CL31C150 JBCNBN □			15pF	50	±5%	1.0
3	CL31C220J BCNBN □			22pF	50	±5%	1.0
4	CL31C270 JBCNBN □			27pF	50	±5%	1.0
5	CL31C330KBCNBN □			33pF	50	±10%	1.0
6	CL31C390KBCNBN □			39pF	50	±10%	1.0
7	CL31C680J BCNBN □			68pF	50	±5%	1.0
8	CL31C820 JBCNBN □			82pF	50	±5%	1.0
9	CL31C101JB CNBN □			100pF	50	±5%	1.0
10	CL31C151KBCNBN □			150pF	50	±10%	1.0
11	CL31C181JB CNBN □			180pF	50	±5%	1.0
12	CL31C331J B CNBN □			330pF	50	±5%	1.0
13	CL31C471JB CNBN □			470pF	50	±5%	1.0
1	CL21B471KBCNBN □	4-Array	2.00 × 1.25	470pF	50	±10%	0.95
2	CL21B104KOCNBN □			100nF	16	±10%	0.95
3	CL21B104MPCNBN □			100nF	10	±20%	0.95
1	CL31B102MBCNBN □	4-Array	3.20 × 1.60	1nF	50	±20%	1.00
2	CL31B103MBCNBN □			10nF	50	±20%	1.00
3	CL31B153KBCNBN □			15nF	50	±10%	1.00
4	CL31B473KACNBN □			47nF	25	±10%	1.00
5	CL31B104KACNBN □			100nF	25	±10%	1.00
6	CL31B104KOCNBN □			100nF	16	±10%	1.00
1	CL09A104KQ4SAN □	2-Array	0.90 × 0.60	100nF	6.3	±10%	0.5
2	CL09A104KP4SAN □			100nF	10	±10%	0.5
1	CL14A104KA6NAN □	2-Array	1.40 × 1.00	100nF	25	±10%	0.66
2	CL14A104KO6NAN □			100nF	16	±10%	0.66
3	CL14A104KP6NAN □			100nF	10	±10%	0.66
1	CL14A105MA5NAN □	2-Array	1.40 × 1.00	1μF	25	±20%	0.55
2	CL14A105KP8NAN □			1μF	10	±20%	0.88
3	CL14A105MO3NAN □			1μF	16	±20%	0.4
4	CL14A105MO8NAN □			1μF	16	±20%	0.88
5	CL14A105MP3NAN □			1μF	10	±20%	0.4
6	CL14A105MP5NAN □			1μF	10	±20%	0.55
7	CL14A225KP8NAN □			2.2μF	10	±10%	0.88
8	CL14A225KQ8NAN □			2.2μF	6.3	±10%	0.88
9	CL14A105MO5NAN □			1μF	16	±10%	0.55
1	CL21A105KOCNAN □	2-Array	2.00 × 1.25	1μF	16	±20%	0.95
2	CL21A105MPCNAN □	2-Array	1.40 × 1.00	1μF	10	±10%	0.88
1	CL31F473ZB CNBN □	4-Array	3.20 × 1.60	47nF	50	80%/-20%	1.0
2	CL31F104ZACNBN □			100nF	25	80%/-20%	1.0

※ □ mark means packaging code. If you want to learn the code or quantity in detail, please see p80.

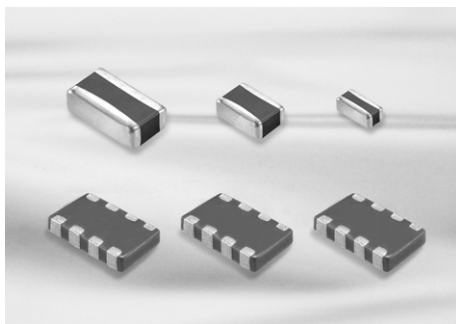

## Feature

- Low ESL, good for noise reduction for high frequency
- Highly reliable tolerance and high speed automatic chip placement on PCBs
- Highly reliable performance
- Highly resistant termination metal
- Tape & reel for surface mount assembly

## Application

- High Speed Microprocessor
- High Frequency Digital Equipment
- ※ For using special purpose like Military, Medical, Aviation, Automobile device should be following a special specification.

## LICC(Low Inductance chip capacitors)

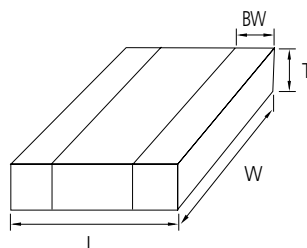

Code	EIA Code	Dimension(mm)			
		L	W	T	BW
L5	0204	$0.52 \pm 0.05$	$1.0 \pm 0.05$	$0.3 \pm 0.05$	$0.18 \pm 0.08$
01	0306	$0.8 \pm 0.15$	$1.6 \pm 0.2$	$0.5 + 0.05 / - 0.1$	$0.25 + 0.15$

## SLIC(Super Low Inductance capacitors)

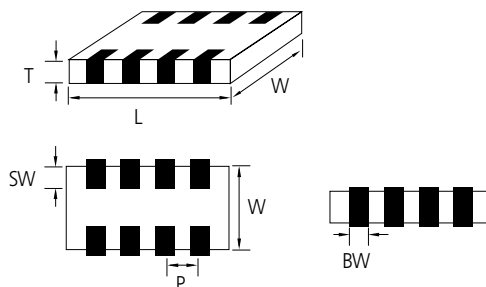

Code	EIA Code	Dimension(mm)					
		L	W	T	BW	SW	P
10	0603	$1.6 \pm 0.1$	$0.8 \pm 0.1$	$0.5 / + 0.05 - 0.1$	$0.25 \pm 0.1$	$0.15 \pm 0.1$	$0.4 \pm 0.1$
21	0805	$2.0 \pm 0.1$	$1.25 \pm 0.1$	$0.5 / + 0.05 - 0.1$	$0.25 \pm 0.1$	$0.18 \pm 0.1$	$0.5 \pm 0.1$

Part Numbering System

General Capacitors

High Capacitance Capacitors

Super Small Size Capacitors

Medium-High Voltage Capacitors

Array Type Capacitors

Low ESL Capacitors

Reliability Test Condition

Premium Capacitors for Automotive Applications

Packaging Specification

Application Manual for Surface Mounting





### Low ESL Capacitors Table (LICC)

TC	Size(mm)	Tmax(mm)	Vr(V)	Capacitance (uF)									
				0.01	0.022	0.047	0.1	0.22	0.47	1	2.2	4.7	10
0402	0204(0510)	0.35mm	4	X6S									
			6.3	X7S									
	0306(0816)	0.55mm	4	X7S									

TC	Size(mm)	Tmax(mm)	Vr(V)	Capacitance (uF)									
				0.01	0.022	0.047	0.1	0.22	0.47	1	2.2	4.7	10
X7R /X5R	0.03(0816)	0.55mm	6.3	X7R				X5R					
			0	X7R									
			16	X7R									
			25	X7R									
			50	X7R									

### Low ESL Capacitors Table (SLIC)

TC	Vr(V)	Tmax(mm)	Vr(V)	Capacitance (uF)							
				0.1	0.47	0.68	1	2.2	4.7	10	22
X7R /X5R /X7T	0603(1608)	0.55	2.5								
			4	X7S							
	0805(0212)	0.55	4	X7S							
			6.3	X7R							
			16	X7R							

**Product Lineup (Low ESL Capacitors-X7R, X6S, X7S)**

	Part Number	Size L×W (mm)	Capacitance	Rated Voltage (Vdc)	Capacitance Tolerance	Thickness Max. (mm)
1	CL21B104MO5NJNI □	2.00×1.25	100nF	16	±20%	0.55
2	CL21B684MO5NJNI □		680nF	16	±20%	0.55
3	CL21B684MQ5NJNI □		680nF	6.3	±20%	0.55
1	CLL5X224MR3NLI □	0.50×1.00	220nF	4	±20%	0.35
2	CLL5X474MR3NLI □		470nF	4	±20%	0.35
1	CLL5Y104MQ3NLI □	0.50×1.00	100nF	6.3	±20%	0.35
2	CL01Y105MR5NLI □	0.80×1.60	1μF	4	±20%	0.55
3	CL01Y225MR5NLI □		2.2μF	4	±20%	0.55
4	CL10Y474MR5NLI □		470nF	4	±20%	0.55
5	CL10Y105MR5NLI □	1.60×0.80	1μF	4	±20%	0.55
6	CL10Y225MR5NLI □		2.2μF	4	±20%	0.55
7	CL21Y105MR5NLI □		2.00×1.25	1μF	4	±20%
8	CL21Y225MR5NLI □	2.2μF		4	±20%	0.55

※ □ mark means packaging code. If you want to learn the code or quantity in detail, please see p80.

Part Numbering System

General Capacitors

High Capacitance Capacitors

Super Small Size Capacitors

Medium-High Voltage Capacitors

Array Type Capacitors

Low ESL Capacitors

Reliability Test Condition



Premium Capacitors for Automotive Applications

Packaging Specification

Application Manual for Surface Mounting

# Reliability Test Condition

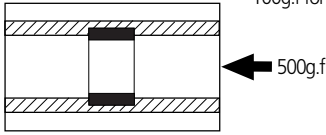
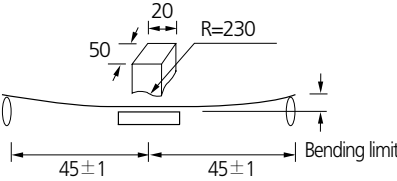
No	Item	Performance	Test Condition		
1	Appearance	No abnormal exterior appearance	Visual Inspection through Microscope(× 10)		
2	Insulation Resistance	10,000MΩ min. or 500MΩ · μF min. (or *100MΩ · μF) product whichever is smaller (Rated voltage ≤ 16V: 10,000MΩ min. or 100MΩ · μF min. product whichever is smaller)	Apply the rated voltage for 60~ 120 sec. Rated voltage > 500V: Insulation Resistance shall be measured with 500 ± 50Vdc		
3	Withstanding Voltage	No dielectric breakdown or mechanical breakdown	Apply the specified voltage* for 1~5 sec. Charge/Discharge current limit: 50mA max. *CLASS I (Rated Voltage < 100V): 300% of the rated Voltage CLASS II (Rated Voltage < 100V): 250% of the rated Voltage In the case of Vr ≥ 100V products, following condition should be applied. 100V ≤ Rated Voltage < 500V: 200% of the rated Voltage 500V ≤ Rated Voltage < 1000V: 150% of the rated Voltage Rated Voltage ≥ 1000V: 120% of the rated Voltage		
4	Capacitance	CLASS I Within the specified tolerance	Capacitance	Frequency	Voltage 0.5 ~ 5 Vrms
			≤ 1,000pF	1MHz ± 10%	
		CLASS II Within the specified tolerance	Capacitance	Frequency	Voltage 1.0 ± 0.2 Vrms
			> 1,000pF	1KHz ± 10%	
5	Q	CLASS I Capacitance ≥ 30pF : Q ≥ 1,000 < 30pF: Q ≥ 400 + 20 × C (C : Capacitance)	Capacitance	Frequency	Voltage 0.5 ~ 5 Vrms
			≤ 1,000pF	1MHz ± 10%	
			> 1,000pF	1KHz ± 10%	
			Capacitance	Frequency	Voltage 1.0 ± 0.2 Vrms
≤ 10μF	1KHz ± 10%				
5	Tanδ	CLASS II	1. Characteristic: A(X5R)		
			Rated Voltage	Spec	
			50V / 35V	0.025 max / 0.05 max*	
			25V	0.025 max / 0.05 max*	
			16V	0.035 max / 0.05 max* / 0.10 max*	
			≤ 10V	0.05 max / 0.10 max*	
			2. Characteristic: B(X7R), X(X6S), Y(X7S)		
			Rated Voltage	Spec	
			50V ≥ / 35V / 25V	0.025 max / 0.05 max* / 0.10 max*	
			16V	0.035 max / 0.10 max*	
			≤ 10V	0.05 max / 0.10 max*	
			3. Characteristic: F(Y5V)		
Rated Voltage	Spec				
50V / 35V / 25V	0.05 max / 0.07 max* / 0.09 max*				
16V	0.07 max / 0.09 max* / 0.125 max*				
10V	0.125 max / 0.16 max*				
≤ 6.3V	0.16 max				
			You can check the specification at the web site or contact sales people for each product with mark*		

No	Item	Performance	Test Condition																		
6	Temperature Characteristics of Capacitance	<table border="1"> <tr> <td colspan="2">CLASS I</td> </tr> <tr> <td>Characteristic</td> <td>Temp. Coefficient (PPM/°C)</td> </tr> <tr> <td>C</td> <td>0 ± 30</td> </tr> </table>	CLASS I		Characteristic	Temp. Coefficient (PPM/°C)	C	0 ± 30	<p>Capacitance shall be measured by the steps shown in the following table.</p> <table border="1"> <tr> <th>Step</th> <th>Temperature(°C)</th> </tr> <tr> <td>1</td> <td>25 ± 2</td> </tr> <tr> <td>2</td> <td>Min. Operating Temp. ± 2</td> </tr> <tr> <td>3</td> <td>25 ± 2</td> </tr> <tr> <td>4</td> <td>Max. Operating Temp. ± 2</td> </tr> <tr> <td>5</td> <td>25 ± 2</td> </tr> </table> <p>(1) CLASS I Temperature Coefficient shall be calculated from the formula as below Temp. Coefficient = <math>\frac{C2 - C1}{C1 \times \Delta T} \times 10^6</math> [ppm/°C] C1: Capacitance at step 3 C2: Capacitance at 85°C <math>\Delta T: 60^\circ\text{C}(=85^\circ\text{C}-25^\circ\text{C})</math></p> <p>(2) CLASS II Capacitance Change shall be calculated from the formula as below <math>\Delta C = \frac{C2 - C1}{C1} \times 100(\%)</math> C1: Capacitance at step 3 C2: Capacitance at step 2 or 4</p>	Step	Temperature(°C)	1	25 ± 2	2	Min. Operating Temp. ± 2	3	25 ± 2	4	Max. Operating Temp. ± 2	5	25 ± 2
		CLASS I																			
Characteristic	Temp. Coefficient (PPM/°C)																				
C	0 ± 30																				
Step	Temperature(°C)																				
1	25 ± 2																				
2	Min. Operating Temp. ± 2																				
3	25 ± 2																				
4	Max. Operating Temp. ± 2																				
5	25 ± 2																				
<table border="1"> <tr> <td colspan="2">CLASS II</td> </tr> <tr> <td>Characteristic</td> <td>Capacitance Change(%) with No bias</td> </tr> <tr> <td>A(X5R) / B(X7R)</td> <td>± 15%</td> </tr> <tr> <td>X(X6S), Y(X7S)</td> <td>± 22%</td> </tr> <tr> <td>F(Y5V)</td> <td>+22%~-82%</td> </tr> </table>	CLASS II		Characteristic	Capacitance Change(%) with No bias	A(X5R) / B(X7R)	± 15%	X(X6S), Y(X7S)	± 22%	F(Y5V)	+22%~-82%											
CLASS II																					
Characteristic	Capacitance Change(%) with No bias																				
A(X5R) / B(X7R)	± 15%																				
X(X6S), Y(X7S)	± 22%																				
F(Y5V)	+22%~-82%																				
7	Adhesive Strength of Termination	No indication of peeling shall occur on the terminal electrode	<p>Apply 500g.f* pressure for 10 ± 1 sec. *200g.f for 0201 *100g.f for 01005</p> 																		
8	Appearance	No indication of peeling shall occur	<ul style="list-style-type: none"> <li>Bending Limit: 1mm</li> <li>Test Speed: 1.0mm/sec.</li> <li>Keep the test board at the limit point in 5 sec.</li> <li>Then Measure Capacitance</li> </ul> 																		
	Capacitance	<table border="1"> <tr> <td>Characteristic</td> <td>Capacitance Change</td> </tr> <tr> <td>CLASS I</td> <td>± 5% or ± 0.5 pF whichever is larger</td> </tr> <tr> <td rowspan="2">CLASS II</td> <td>A(X5R), B(X7R), X(X6S), Y(X7S)</td> <td>± 12.5%</td> </tr> <tr> <td>F(Y5V)</td> <td>± 30%</td> </tr> </table>		Characteristic	Capacitance Change	CLASS I	± 5% or ± 0.5 pF whichever is larger	CLASS II	A(X5R), B(X7R), X(X6S), Y(X7S)	± 12.5%	F(Y5V)	± 30%									
Characteristic	Capacitance Change																				
CLASS I	± 5% or ± 0.5 pF whichever is larger																				
CLASS II	A(X5R), B(X7R), X(X6S), Y(X7S)	± 12.5%																			
	F(Y5V)	± 30%																			
9	Solderability	<p>More than 75% of the terminal surface is to be soldered newly, so metal part does not come out or dissolve</p> 	<table border="1"> <tr> <td>Solder</td> <td>Sn-3Ag-0.5Cu</td> </tr> <tr> <td>Solder Temp.</td> <td>245 ± 5°C</td> </tr> <tr> <td>Flux</td> <td>RMA Type</td> </tr> <tr> <td>Dip time</td> <td>3 ± 0.3 sec.</td> </tr> <tr> <td>Pre-heating</td> <td>at 80~120°C for 10~30 sec.</td> </tr> </table>	Solder	Sn-3Ag-0.5Cu	Solder Temp.	245 ± 5°C	Flux	RMA Type	Dip time	3 ± 0.3 sec.	Pre-heating	at 80~120°C for 10~30 sec.								
Solder	Sn-3Ag-0.5Cu																				
Solder Temp.	245 ± 5°C																				
Flux	RMA Type																				
Dip time	3 ± 0.3 sec.																				
Pre-heating	at 80~120°C for 10~30 sec.																				
10	Appearance	No mechanical damage shall occur	<p>Solder temperature: 270 ± 5°C DIP TIME: 10 ± 1 sec. Each termination shall be fully immersed and preheated as below:</p> <table border="1"> <tr> <th>Step</th> <th>Temperature(°C)</th> <th>Time (sec.)</th> </tr> <tr> <td>1</td> <td>80~100</td> <td>60</td> </tr> <tr> <td>2</td> <td>150~180</td> <td>60</td> </tr> </table> <p>Leave the capacitor in ambient condition for specified time* before measurement *24 ± 2 hours(CLASS I) 24 ± 2 hours(CLASS II)</p>	Step	Temperature(°C)	Time (sec.)	1	80~100	60	2	150~180	60									
	Step	Temperature(°C)		Time (sec.)																	
	1	80~100		60																	
	2	150~180		60																	
	Capacitance	<table border="1"> <tr> <td>Characteristic</td> <td>Capacitance Change</td> </tr> <tr> <td>CLASS I</td> <td>± 2.5% or ± 0.25 pF whichever is larger</td> </tr> <tr> <td rowspan="2">CLASS II</td> <td>A(X5R), B(X7R)</td> <td>± 7.5%</td> </tr> <tr> <td>X(X6S), Y(X7S)</td> <td>± 20%</td> </tr> </table>		Characteristic	Capacitance Change	CLASS I	± 2.5% or ± 0.25 pF whichever is larger	CLASS II	A(X5R), B(X7R)	± 7.5%	X(X6S), Y(X7S)	± 20%									
		Characteristic		Capacitance Change																	
CLASS I		± 2.5% or ± 0.25 pF whichever is larger																			
CLASS II	A(X5R), B(X7R)	± 7.5%																			
	X(X6S), Y(X7S)	± 20%																			
Q (CLASS I)	Within the specified initial value																				
Tanδ (CLASS II)	Within the specified initial value																				
Insulation resistance	Within the specified initial value																				
Withstanding voltage	Within the specified initial value																				

Part Numbering System

General Capacitors

High Capacitance Capacitors

Super Small Size Capacitors

Medium-High Voltage Capacitors

Array Type Capacitors

Low ESL Capacitors

Reliability Test Condition

Premium Capacitors for Automotive Applications

Packaging Specification

Application Manual for Surface Mounting



No	Item	Performance	Test Condition			
11	Vibration Test	Appearance	No mechanical damage shall occur	<p>The capacitor shall be subjected to a harmonic motion having a total amplitude of 1.5mm changing frequency from 10Hz to 55Hz and back to 10Hz in about 1 min.</p> <p>Repeat this for 2hours each in 3 mutually perpendicular directions.</p>		
		Capacitance	Characteristic		Capacitance Change	
			CLASS I		$\pm 2.5\%$ or $\pm 0.25$ pF whichever is larger	
			CLASS II		A(X5R), B(X7R)	$\pm 5\%$
					X(X6S), Y(X7S)	$\pm 10\%$
		F(Y5V)			$\pm 20\%$	
		Q (CLASS I)	Within the specified initial value			
Tan $\delta$ (CLASS II)	Within the specified initial value					
Insulation resistance	Within the specified initial value					
12	Moisture Resistance	Appearance	No mechanical damage shall occur	<p>Applied Voltage: rated voltage Temperature: <math>40 \pm 2^\circ\text{C}</math> Humidity: 90~95% RH Duration Time: 500+12/0 Hr. Charge/Discharge Current: 50mA max.</p> <p>Perform the initial measurement according to Note1. Perform the final measurement according to Note2.</p> <p>This test is only applied to <math>V_r \leq 500V</math> products. You can check the specification at the web site or contact sales people for each product with mark*</p>		
		Capacitance	Characteristic		Capacitance Change	
			CLASS I		$\pm 7.5\%$ or $\pm 0.75$ pF whichever is larger	
			CLASS II		A(X5R), B(X7R), X(X6S), Y(X7S)	$\pm 12.5\%$
					F(Y5V)	$\pm 30\%$
		Q (CLASS I)			Capacitance $\geq 30$ pF : $Q \geq 200$ $< 30$ pF : $Q \geq 100 + 10/3 \times C$ (C: Capacitance)	
Tan $\delta$ (CLASS II)	<p>1.Capacitance: A(X5R) 0.05 max / 0.075 max* (35V / 50V) 0.05 max / 0.075 max* / 0.125 max* (16V / 25V) 0.075 max / 0.125 max* (<math>\leq 10V</math>)</p> <p>2.Capacitance: B(X7R), X(X6S) 0.05 max / 0.125 max* (16V / 25V / 35V / 50V<math>\geq</math>) 0.075 max / 0.125 max* (<math>\leq 10V</math>)</p> <p>3.Capacitance: F(Y5V) 0.09 max (50V) 0.09 max / 0.125 max* (25V / 35V) 0.09 max / 0.125 max* / 0.16 max* (16V) 0.16 max / 0.195 max* (10V) 0.195 max (4V / 6.3V)</p>					
Insulation resistance	500M $\Omega$ min. or 25M $\Omega \cdot \mu\text{F}$ min. product whichever is smaller / 12.5M $\Omega \cdot \mu\text{F}$ or over*					
13	High Temperature Resistance	Appearance	No mechanical damage shall occur	<p>Temperature : max. operating temperature</p> <p>Duration Time: 1000+48/0 Hr. Charge/Discharge Current: 50mA max.</p> <p><math>V_r \leq 200V</math> : 200% of the rated Voltage <math>250V \leq V_r \leq 500V</math>: 150% of the rated Voltage <math>V_r = 630V</math> : 120% of the rated Voltage <math>1000V \leq V_r \leq 3000V</math>: 100% of the rated Voltage * : 150% or 100% of the rated Voltage</p> <p>Perform the initial measurement according to Note1 for class II Perform the final measurement according to Note2.</p> <p>You can check the specification at the web site or contact sales people for each product with mark*</p>		
		Capacitance	Characteristic		Capacitance Change	
			CLASS I		$\pm 3\%$ or $\pm 0.3$ pF whichever is larger	
			CLASS II		A(X5R), B(X7R), X(X6S), Y(X7S)	$\pm 12.5\%$
					F(Y5V)	$\pm 30\%$
		Q (CLASS I)			Capacitance $\geq 30$ pF : $Q \geq 350$ $10 \leq \text{Capacitance} < 30$ pF : $Q \geq 275 + 2.5 \times C$ Capacitance $< 10$ pF : $Q \geq 200 + 10 \times C$ (C: Capacitance)	
Tan $\delta$ (CLASS II)	<p>1.Capacitance: A(X5R) 0.05 max / 0.075 max* (35V / 50V) 0.05 max / 0.075 max* / 0.125 max* (16V / 25V) 0.075 max / 0.125 max* (<math>\leq 10V</math>)</p> <p>2.Capacitance: B(X7R), X(X6S) 0.05 max / 0.125 max* (16V / 25V / 35V / 50V<math>\geq</math>) 0.075 max / 0.125 max* (<math>\leq 10V</math>)</p> <p>3.Capacitance: F(Y5V) 0.09 max (50V) 0.09 max / 0.125 max* (25V / 35V) 0.09 max / 0.125 max* / 0.16 max* (16V) 0.16 max / 0.195 max* (10V) 0.195 max (4V / 6.3V)</p>					
Insulation resistance	1,000M $\Omega$ min. or 50M $\Omega \cdot \mu\text{F}$ min. product whichever is smaller / 25M $\Omega \cdot \mu\text{F}$ or over*					

No	Item	Performance	Test Condition															
14	Temperature Cycle	Appearance	No mechanical damage shall occur															
		Capacitance	Characteristic	Capacitance Change														
			CLASS I		$\pm 2.5\%$ or $\pm 0.25\text{pF}$ whichever is larger													
			CLASS II	A(X5R), B(X7R)	$\pm 7.5\%$													
				X(X6S), Y(X7S)	$\pm 15\%$													
		F(Y5V)		$\pm 20\%$														
		Q (CLASS I)	Within the specified initial value															
Tan $\delta$ (CLASS II)	Within the specified initial value																	
Insulation resistance	Within the specified initial value																	
			Capacitor shall be subjected to 5 cycles. Condition for 1 cycle:															
			<table border="1"> <thead> <tr> <th>Step</th> <th>Temperature(°C)</th> <th>Time(min.)</th> </tr> </thead> <tbody> <tr> <td>1</td> <td>min. operating temperature +0/-3</td> <td>30</td> </tr> <tr> <td>2</td> <td>25</td> <td>2~3</td> </tr> <tr> <td>3</td> <td>max. operating temperature +0/-3</td> <td>30</td> </tr> <tr> <td>4</td> <td>25</td> <td>2~3</td> </tr> </tbody> </table>	Step	Temperature(°C)	Time(min.)	1	min. operating temperature +0/-3	30	2	25	2~3	3	max. operating temperature +0/-3	30	4	25	2~3
Step	Temperature(°C)	Time(min.)																
1	min. operating temperature +0/-3	30																
2	25	2~3																
3	max. operating temperature +0/-3	30																
4	25	2~3																
			Leave the capacitor in ambient condition for specified time* before measurement *24 $\pm$ 2 hours(CLASS I) 24 $\pm$ 2 hours(CLASS II)															

No	Recommended Soldering Method						
15	Recommended Soldering Method By Size & Capacitance	Size inch(mm)	Temperature Characteristic	Capacitance	Condition		
					Flow	Reflow	
		01005(0402)	-	-	-	-	○
		0201 (0603)					
		0402 (1005)					
		0603(1608)	Class I	-	○	○	
			Class II	$C < 1\mu\text{F}$	○	○	
					$C \geq 1\mu\text{F}$	-	○
		0805 (2012)	Class I	-	○	○	
			Class II	$C < 4.7\mu\text{F}$	○	○	
					$C \geq 4.7\mu\text{F}$	-	○
			Array	-	-	○	
		1206 (3216)	Class I	-	○	○	
			Class II	$C < 10\mu\text{F}$	○	○	
					$C \geq 10\mu\text{F}$	-	○
	Array	-	-	○			
1210 (3225)	-	-	-	-	○		
1808 (4520)					○		
1812 (4532)					○		
2220 (5750)					○		
					○		

**Note1. Initial Measurement For Class II**

Perform the heat treatment at 150°C+0/-10°C for 1 hour. Then Leave the capacitor in ambient condition for 24  $\pm$  2 hours before measurement. Then perform the measurement.

**Note2. Latter Measurement**

1. CLASS I

Leave the capacitor in ambient condition for 24  $\pm$  2 hours before measurement. Then perform the measurement.

2. CLASS II

Perform the heat treatment at 150°C+0/-10°C for 1 hour. Then Leave the capacitor in ambient condition for 24  $\pm$  2 hours before measurement. Then perform the measurement.

Note3. All Size in Reliability Test Condition Section is "inch"

Note4. Camera Strobe Circuit Capacitors Should be Following a Special Reliability Test Condition.

Please check with our sales representatives or product engineers.

Part Numbering System

General Capacitors

High Capacitance Capacitors

Super Small Size Capacitors

Medium-High Voltage Capacitors

Array Type Capacitors

Low ESL Capacitors

Reliability Test Condition

Premium Capacitors for Automotive Applications

Packaging Specification

Application Manual for Surface Mounting

S A M S U N G E L E C T R O - M E C H A N I C S



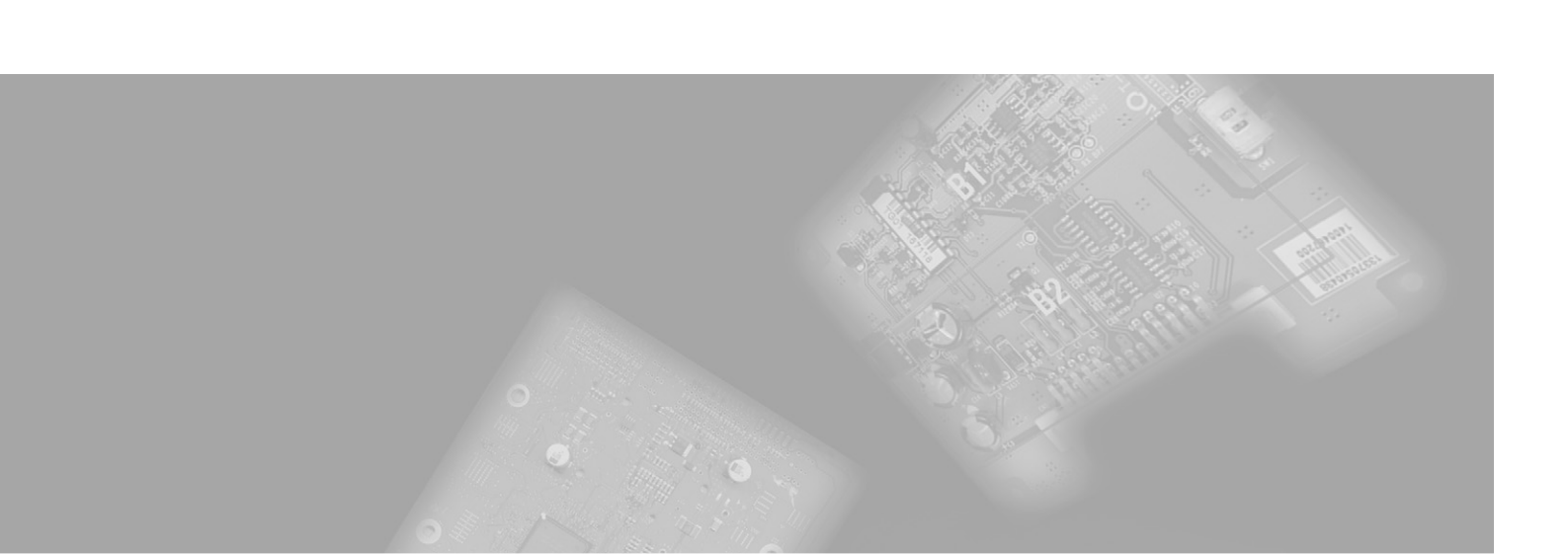

*Premium Capacitors for Automotive Applications*

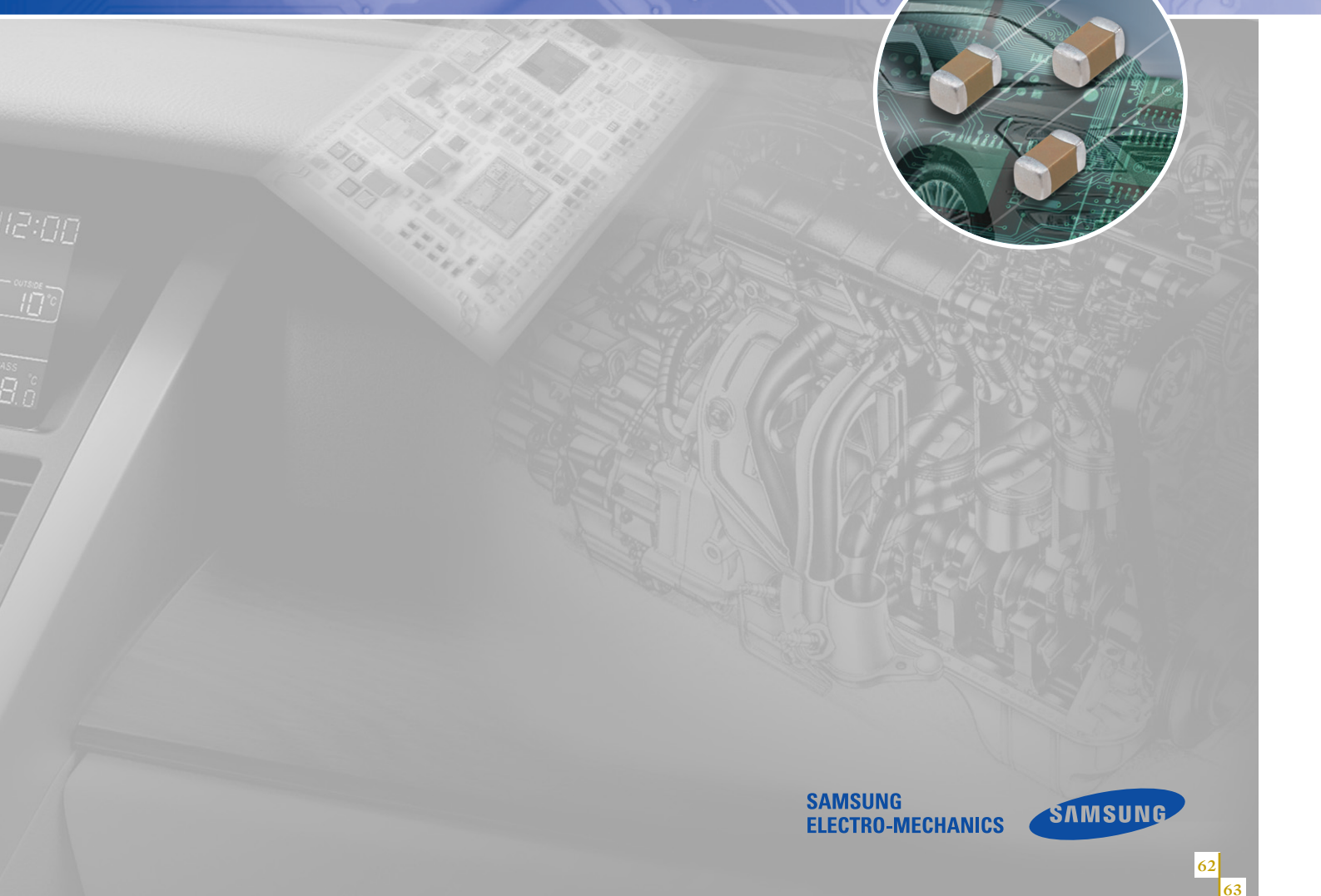
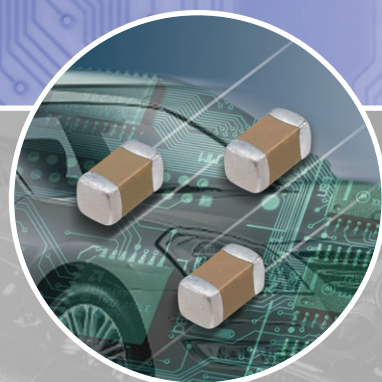

**SAMSUNG  
ELECTRO-MECHANICS**





# Premium Capacitors for Automotive Applications

## Part Numbering System (Automotive Capacitors)

	<b>CL</b>	<b>10</b>	<b>B</b>	<b>104</b>	<b>K</b>	<b>B</b>	<b>8</b>	<b>5</b>	<b>P</b>	<b>N</b>	<b>C</b>
	<b>1</b>	<b>2</b>	<b>3</b>	<b>4</b>	<b>5</b>	<b>6</b>	<b>7</b>	<b>8</b>	<b>9</b>	<b>10</b>	<b>11</b>
<b>1. SERIES CODE</b> _____ CL=Multi layer Ceramic Capacitors											
<b>2. SIZE CODE</b> — <b>inch (mm)</b> _____ 05=1005(0402)    10=1608(0603)    21=2012(0805) 31=3216(1206)    32=3225(1210)											
* <b>3. DIELECTRIC CODE</b> _____ C=C0G (Class I)    B=X7R (Class II)											
<b>4. CAPACITANCE CODE</b> _____ Capacitance expressed in pF. 2 significant digits plus number of zeros. example) 106=10 × 10 <sup>6</sup> =10000000pF For Values < 10pF, Letter R denotes decimal point example) 1R5=1.5pF											
** <b>5. TOLERANCE CODE</b> _____ C=±0.25pF    D=±0.5pF    F=±1pF, ±1%*    G=±2% J=±5%    K=±10%    M=±20% *For Values ≤10pF, F=±1pF, Values>10pF, F=±1% ※This code has only typical specifications. Please refer to individual specifications.											
<b>6. RATED VOLTAGE CODE</b> _____ P=10V    O=16V A=25V    B=50V    C=100V											
*** <b>7. THICKNESS CODE</b> _____ 5 = 0.50mm    6= 0.60mm    8 = 0.80mm    C = 0.85mm P = 1.15mm    F = 1.25mm    H = 1.60mm    J = 2.50mm ※This code has only typical specifications. Please refer to individual specifications.											
<b>8. DESIGN CODE</b> _____ 1=Ni/Cu/Ni Barrier/Sn 100%/Standard 4=Ni/Cu+Ag-Epoxy/Ni Barrier/Sn 100%/Standard 5=Ni/Cu+Ag-Epoxy/Ni Barrier/Sn 100%/Open Mode ※This code has only typical specifications. Please refer to individual specifications.											
<b>9. PRODUCT CODE</b> _____ P=Automotive product meet JEDEC-020-D requirements. ※If orders are placed without returned specification, please allow us to judge that specification is accepted by your side.											
<b>10. GRADE CODE</b> _____ N=Standard											
<b>11. PACKAGING CODE</b> _____ B = Bulk    O = Cardboard Tape, 10" Reel    E = Embossed Type, 7" Reel P = Bulk Case    D = Cardboard Tape, 13" Reel(10,000ea)    F = Embossed Type, 13" Reel C = Cardboard Tape, 7" Reel    L = Cardboard Tape, 13" Reel(15,000ea)    S = Embossed Type, 10" Reel											

This catalog has only typical specifications because there is no space for detailed specifications.  
 Please approve our product specifications or transact the approval sheet for product specifications before ordering.

★  
Class I

Symbol	EIA Code	Operation Temperature Range(°C)	Temperature Coefficient Range(ppm/°C)
C	COG	-55 ~ +125	0 ±30

Class II

Symbol	EIA Code	Operation Temperature Range(°C)	Capacitance Change (ΔC %)
B	X7R	-55 ~ +125	0 ±15

★★  
Capacitance Tolerance

Code	Capacitance Tolerance	TC	Capacitance Step	Rated Capacitance
C	± 0.25 pF	COG	Under 5 pF	E-12 series ★
D	± 0.5 pF	COG	6.0 to 9.0 pF	E-12 series ★
J	± 5%	COG	Over 10 pF	E-12 series
K	± 10%	X7R	Under 0.01 μF	E-3 series
			Over 0.01 μF	E-6 series
M	± 20%	X7R	Under 0.01 μF	E-3 series
			Over 0.01 μF	E-6 series

★E-24 series is also available

Series	Capacitance Step											
	1.0				2.2				4.7			
E-3	1.0				2.2				4.7			
E-6	1.0		1.5		2.2		3.3		4.7		6.8	
E-12	1.0	1.2	1.5	1.8	2.2	2.7	3.3	3.9	4.7	5.6	6.8	8.2
E-24	1.0	1.1	1.2	1.3	2.2	2.4	2.7	3.0	4.7	5.1	5.6	6.2
	1.5	1.6	1.8	2.0	3.3	3.6	3.9	4.3	6.8	7.5	8.2	9.1

★★★

Size	Code	Thickness(mm)	Spec(mm) ★
0402(1005)	5	0.50	±0.05
0603(1608)	8	0.80	±0.10
0805(2012)	6	0.60	±0.10
	C	0.85	±0.10
	F	1.25	±0.10
1206(3216)	C	0.85	±0.15
	P	1.15	±0.10
	H	1.60	±0.20

★The tolerance will be changed by Customer' standards and our new products. (High Capacitance)  
Please check with our sales representatives or product engineers before ordering.

Part Numbering System

General Capacitors

High Capacitance Capacitors

Super Small Size Capacitors

Medium-High Voltage Capacitors

Array Type Capacitors

Low ESL Capacitors

Reliability Test Condition

Premium Capacitors for Automotive Applications

Packaging Specification

Application Manual for Surface Mounting

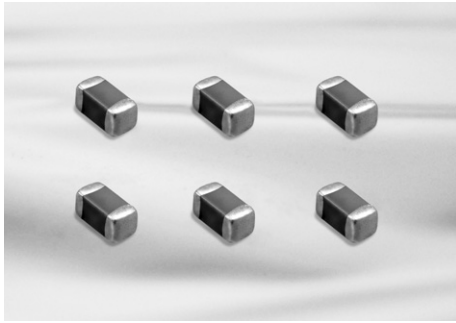

### Feature

- Automotive products are manufactured in state of the art facilities recommended for registration to ISO/TS 16949:2002.
- Automotive products meet AEC-Q-200 requirements.
- Automotive products are RoHS compliant.
- Samsung terminations are suitable for all flow and reflow soldering systems. (10/21/31 size type only)
- Automotive products meet JEDEC-020-D requirements.
- COG dielectric components contain BME and copper terminations with a Ni/Sn plated overcoat.
- X7R dielectric components have BME and soft terminations with a Ni/Sn plated overcoat.

### Application

- Automotive Electronic Equipment  
(Powertrain, Safety, Body & Chassis, Convenience, Infotainment)

### Structure and Dimensions

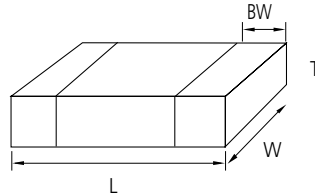

Code	EIA Code	Dimension(mm)			
		L	W	T	BW
05	0402	1.00±0.05	0.50±0.05	0.50(±0.05)	0.2+0.15/-0.1
10	0603	1.60±0.10	0.80±0.10	0.80(±0.10)	0.3±0.2
21	0805	2.00±0.10	1.25±0.10	0.60(±0.10)	0.5±0.2/-0.3
				0.85(±0.10)	
				1.25(±0.10)	
31	1206	3.20±0.20	1.60±0.20	0.85(±0.15)	0.5±0.3
				1.15(±0.10)	
				1.60(±0.20)	

**Automotive Capacitors Table (COG, X7R)**

TC	Size(mm)	Vr	Capacitance (pF)			Capacitance (nF)					
			100	220	470	1	2.2	4.7	10	22	47
COG	0402(1005)	50	[Bar]								
		100	[Bar]								
	0603(1608)	50	[Bar]								
		100	[Bar]								
	0805(2012)	50	[Bar]								
		100	[Bar]								

TC	Size(mm)	Thickness (mm)	Vr	Capacitance (nF)					Capacitance (uF)				
				10	22	47	100	220	470	1	2.2	4.7	10
X7R	0603(1608)	0.8	10	[Bar]									
		0.8	16	[Bar]									
		0.8	25	[Bar]									
		0.8	50	[Bar]									
		0.8	100	[Bar]									
	0805(2012)	1.25	10	[Bar]									
			16	[Bar]									
			25	[Bar]									
		0.6	25	10	[Bar]								
				16	[Bar]								
			50	10	[Bar]								
				16	[Bar]								
		100	0.6	10	[Bar]								
				16	[Bar]								
				25	[Bar]								
	0.85		10	[Bar]									
			16	[Bar]									
	1206(3216)	1.6	10	[Bar]									
			16	[Bar]									
			25	[Bar]									
		0.85	50	10	[Bar]								
				16	[Bar]								
				25	[Bar]								
		1.15	50	10	[Bar]								
16				[Bar]									
1.6	50	[Bar]											

- Part Numbering System
- General Capacitors
- High Capacitance Capacitors
- Super Small Size Capacitors
- Medium-High Voltage Capacitors
- Array Type Capacitors
- Low ESL Capacitors
- Reliability Test Condition
- Premium Capacitors for Automotive Applications
- Packaging Specification
- Application Manual for Surface Mounting



Product Lineup (Automotive Capacitors\_COG)

	Part Number	Size L×W (mm)	Capacitance	Rated Voltage (Vdc)	Capacitance Tolerance	Thickness Max. (mm)
1	CL05C010CB51PN □	1.00×0.50	1.0pF	50	±0.25pF	0.55
2	CL05C010CC51PN □		1.0pF	100	±0.25pF	0.55
3	CL05C1R5CB51PN □		1.5pF	50	±0.25pF	0.55
4	CL05C1R5CC51PN □		1.5pF	100	±0.25pF	0.55
5	CL05C2R2CB51PN □		2.2pF	50	±0.25pF	0.55
6	CL05C2R2CC51PN □		2.2pF	100	±0.25pF	0.55
7	CL05C3R3CB51PN □		3.3pF	50	±0.25pF	0.55
8	CL05C3R3CC51PN □		3.3pF	100	±0.25pF	0.55
9	CL05C4R7CB51PN □		4.7pF	50	±0.25pF	0.55
10	CL05C4R7CC51PN □		4.7pF	100	±0.25pF	0.55
11	CL05C6R8DB51PN □		6.8pF	50	±0.5pF	0.55
12	CL05C6R8DC51PN □		6.8pF	100	±0.5pF	0.55
13	CL05C100JB51PN □		10pF	50	±5%	0.55
14	CL05C100JC51PN □		10pF	100	±5%	0.55
15	CL05C120JB51PN □		12pF	50	±5%	0.55
16	CL05C120JC51PN □		12pF	100	±5%	0.55
17	CL05C150JB51PN □		15pF	50	±5%	0.55
18	CL05C150JC51PN □		15pF	100	±5%	0.55
19	CL05C180JB51PN □		18pF	50	±5%	0.55
20	CL05C180JC51PN □		18pF	100	±5%	0.55
21	CL05C220JB51PN □		22pF	50	±5%	0.55
22	CL05C220JC51PN □		22pF	100	±5%	0.55
23	CL05C270JB51PN □		27pF	50	±5%	0.55
24	CL05C270JC51PN □		27pF	100	±5%	0.55
25	CL05C330JB51PN □		33pF	50	±5%	0.55
26	CL05C330JC51PN □		33pF	100	±5%	0.55
27	CL05C390JB51PN □		39pF	50	±5%	0.55
28	CL05C390JC51PN □		39pF	100	±5%	0.55
29	CL05C470JB51PN □		47pF	50	±5%	0.55
30	CL05C470JC51PN □		47pF	100	±5%	0.55
31	CL05C560JB51PN □		56pF	50	±5%	0.55
32	CL05C560JC51PN □		56pF	100	±5%	0.55
33	CL05C680JB51PN □		68pF	50	±5%	0.55
34	CL05C680JC51PN □		68pF	100	±5%	0.55
35	CL05C820JB51PN □		82pF	50	±5%	0.55
36	CL05C820JC51PN □		82pF	100	±5%	0.55
37	CL05C101JB51PN □		100pF	50	±5%	0.55
38	CL05C101JC51PN □		100pF	100	±5%	0.55
39	CL05C121JB51PN □		120pF	50	±5%	0.55
40	CL05C151JB51PN □		150pF	50	±5%	0.55
41	CL05C221JB51PN □		220pF	50	±5%	0.55
1	CL10C010CB81PN □	1.60×0.80	1.0pF	50	±0.25pF	0.9
2	CL10C010CC81PN □		1.0pF	100	±0.25pF	0.9
3	CL10C1R5CB81PN □		1.5pF	50	±0.25pF	0.9
4	CL10C1R5CC81PN □		1.5pF	100	±0.25pF	0.9

※ □ mark means packaging code. If you want to learn the code or quantity in detail, please see p80.

Product Lineup (Automotive Capacitors\_COG)

	Part Number	Size L×W (mm)	Capacitance	Rated Voltage (Vdc)	Capacitance Tolerance	Thickness Max. (mm)
5	CL10C2R2CB81PN □	1.60×0.80	2.2pF	50	±0.25pF	0.9
6	CL10C2R2CC81PN □		2.2pF	100	±0.25pF	0.9
7	CL10C3R3CB81PN □		3.3pF	50	±0.25pF	0.9
8	CL10C3R3CC81PN □		3.3pF	100	±0.25pF	0.9
9	CL10C4R7CB81PN □		4.7pF	50	±0.25pF	0.9
10	CL10C4R7CC81PN □		4.7pF	100	±0.25pF	0.9
11	CL10C6R8DB81PN □		6.8pF	50	±0.5pF	0.9
12	CL10C6R8DC81PN □		6.8pF	100	±0.5pF	0.9
13	CL10C100JB81PN □		10pF	50	±5%	0.9
14	CL10C100JC81PN □		10pF	100	±5%	0.9
15	CL10C120JB81PN □		12pF	50	±5%	0.9
16	CL10C120JC81PN □		12pF	100	±5%	0.9
17	CL10C150JB81PN □		15pF	50	±5%	0.9
18	CL10C150JC81PN □		15pF	100	±5%	0.9
19	CL10C180JB81PN □		18pF	50	±5%	0.9
20	CL10C180JC81PN □		18pF	100	±5%	0.9
21	CL10C220JB81PN □		22pF	50	±5%	0.9
22	CL10C220JC81PN □		22pF	100	±5%	0.9
23	CL10C270JB81PN □		27pF	50	±5%	0.9
24	CL10C270JC81PN □		27pF	100	±5%	0.9
25	CL10C330JB81PN □		33pF	50	±5%	0.9
26	CL10C330JC81PN □		33pF	100	±5%	0.9
27	CL10C390JB81PN □		39pF	50	±5%	0.9
28	CL10C390JC81PN □		39pF	100	±5%	0.9
29	CL10C470JB81PN □		47pF	50	±5%	0.9
30	CL10C470JC81PN □		47pF	100	±5%	0.9
31	CL10C560JB81PN □		56pF	50	±5%	0.9
32	CL10C560JC81PN □		56pF	100	±5%	0.9
33	CL10C680JB81PN □		68pF	50	±5%	0.9
34	CL10C680JC81PN □		68pF	100	±5%	0.9
35	CL10C820JB81PN □		82pF	50	±5%	0.9
36	CL10C820JC81PN □		82pF	100	±5%	0.9
37	CL10C101JB81PN □		100pF	50	±5%	0.9
38	CL10C101JC81PN □		100pF	100	±5%	0.9
39	CL10C121JB81PN □		120pF	50	±5%	0.9
40	CL10C151JB81PN □		150pF	50	±5%	0.9
41	CL10C221JB81PN □		220pF	50	±5%	0.9
42	CL10C271JB81PN □		270pF	50	±5%	0.9
43	CL10C331JB81PN □		330pF	50	±5%	0.9
44	CL10C391JB81PN □		390pF	50	±5%	0.9
45	CL10C471JB81PN □		470pF	50	±5%	0.9
46	CL10C561JB81PN □		560pF	50	±5%	0.9
47	CL10C681JB81PN □		680pF	50	±5%	0.9
48	CL10C821JB81PN □		820pF	50	±5%	0.9
49	CL10C102JB81PN □		1000pF	50	±5%	0.9

※ □ mark means packaging code. If you want to learn the code or quantity in detail, please see p80.

- Part Numbering System
- General Capacitors
- High Capacitance Capacitors
- Super Small Size Capacitors
- Medium-High Voltage Capacitors
- Array Type Capacitors
- Low ESL Capacitors
- Reliability Test Condition
- Premium Capacitors for Automotive Applications
- Packaging Specification
- Application Manual for Surface Mounting



## Product Lineup (Automotive Capacitors\_COG)

	Part Number	Size L×W (mm)	Capacitance	Rated Voltage (Vdc)	Capacitance Tolerance	Thickness Max. (mm)
1	CL21C100JB61PN □	2.00×1.25	10pF	50	±5%	0.7
2	CL21C100JC61PN □		10pF	100	±5%	0.7
3	CL21C120JB61PN □		12pF	50	±5%	0.7
4	CL21C120JC61PN □		12pF	100	±5%	0.7
5	CL21C150JB61PN □		15pF	50	±5%	0.7
6	CL21C150JC61PN □		15pF	100	±5%	0.7
7	CL21C180JB61PN □		18pF	50	±5%	0.7
8	CL21C180JC61PN □		18pF	100	±5%	0.7
9	CL21C220JB61PN □		22pF	50	±5%	0.7
10	CL21C220JC61PN □		22pF	100	±5%	0.7
11	CL21C270JC61PN □		27pF	100	±5%	0.7
12	CL21C330JB61PN □		33pF	50	±5%	0.7
13	CL21C330JC61PN □		33pF	100	±5%	0.7
14	CL21C390JB61PN □		39pF	50	±5%	0.7
15	CL21C390JC61PN □		39pF	100	±5%	0.7
16	CL21C470JB61PN □		47pF	50	±5%	0.7
17	CL21C470JC61PN □		47pF	100	±5%	0.7
18	CL21C560JB61PN □		56pF	50	±5%	0.7
19	CL21C560JC61PN □		56pF	100	±5%	0.7
20	CL21C680JB61PN □		68pF	50	±5%	0.7
21	CL21C680JC61PN □		68pF	100	±5%	0.7
22	CL21C820JB61PN □		82pF	50	±5%	0.7
23	CL21C820JC61PN □		82pF	100	±5%	0.7
24	CL21C101JB61PN □		100pF	50	±5%	0.7
25	CL21C101JC61PN □		100pF	100	±5%	0.7
26	CL21C121JB61PN □		120pF	50	±5%	0.7
27	CL21C121JC61PN □		120pF	100	±5%	0.7
28	CL21C151JB61PN □		150pF	50	±5%	0.7
29	CL21C151JC61PN □		150pF	100	±5%	0.7
30	CL21C221JB61PN □		220pF	50	±5%	0.7
31	CL21C221JC61PN □		220pF	100	±5%	0.7
32	CL21C271JB61PN □		270pF	50	±5%	0.7
33	CL21C271JC61PN □		270pF	100	±5%	0.7
34	CL21C331JB61PN □		330pF	50	±5%	0.7

※ □ mark means packaging code. If you want to learn the code or quantity in detail, please see p80.

**Product Lineup (Automotive Capacitors\_COG)**

	Part Number	Size L×W (mm)	Capacitance	Rated Voltage (Vdc)	Capacitance Tolerance	Thickness Max. (mm)
35	CL21C331JC61PN □	2.00×1.25	330pF	100	±5%	0.7
36	CL21C471JBC1PN □		470pF	50	±5%	0.95
37	CL21C471JCC1PN □		470pF	100	±5%	0.95
38	CL21C561JBC1PN □		560pF	50	±5%	0.95
39	CL21C561JCC1PN □		560pF	100	±5%	0.95
40	CL21C681JBC1PN □		680pF	50	±5%	0.95
41	CL21C681JCC1PN □		680pF	100	±5%	0.95
42	CL21C821JBC1PN □		820pF	50	±5%	0.95
43	CL21C821JCC1PN □		820pF	100	±5%	0.95
44	CL21C102JBC1PN □		1000pF	50	±5%	0.95
45	CL21C102JCC1PN □		1000pF	100	±5%	0.95
46	CL21C102JCF1PN □		1000pF	100	±5%	1.35
47	CL21C122JBC1PN □		1200pF	50	±5%	0.95
48	CL21C152JBC1PN □		1500pF	50	±5%	0.95
49	CL21C182JBC1PN □		1800pF	50	±5%	0.95
50	CL21C222JBC1PN □		2200pF	50	±5%	0.95
51	CL21C272JBC1PN □		2700pF	50	±5%	0.95
52	CL21C332JBC1PN □		3300pF	50	±5%	0.95
53	CL21C392JBC1PN □		3900pF	50	±5%	0.95
54	CL21C472JBC1PN □		4700pF	50	±5%	0.95
55	CL21C562JBC1PN □		5600pF	50	±5%	0.95
56	CL21C102JBF1PN □		1000pF	50	±5%	1.35
57	CL21C122JBF1PN □		1200pF	50	±5%	1.35
58	CL21C152JBF1PN □		1500pF	50	±5%	1.35
59	CL21C182JBF1PN □		1800pF	50	±5%	1.35
60	CL21C222JBF1PN □		2200pF	50	±5%	1.35
61	CL21C272JBF1PN □		2700pF	50	±5%	1.35
62	CL21C332JBF1PN □		3300pF	50	±5%	1.35
63	CL21C392JBF1PN □		3900pF	50	±5%	1.35
64	CL21C472JBF1PN □		4700pF	50	±5%	1.35
65	CL21C562JBF1PN □		5600pF	50	±5%	1.35
66	CL21C682JBF1PN □		6800pF	50	±5%	1.35
67	CL21C822JBF1PN □		8200pF	50	±5%	1.35
68	CL21C103JBF1PN □		10000pF	50	±5%	1.35

※ □ mark means packaging code. If you want to learn the code or quantity in detail, please see p80.

- Part Numbering System
- General Capacitors
- High Capacitance Capacitors
- Super Small Size Capacitors
- Medium-High Voltage Capacitors
- Array Type Capacitors
- Low ESL Capacitors
- Reliability Test Condition
- Premium Capacitors for Automotive Applications
- Packaging Specification
- Application Manual for Surface Mounting





Product Lineup (Automotive Capacitors\_X7R)

	Part Number	Size L×W (mm)	Capacitance	Rated Voltage (Vdc)	Capacitance Tolerance	Thickness Max. (mm)
1	CL10B221KC85PN □	1.60×0.80	0.22nF	100	±10%	0.90
2	CL10B471KC85PN □		0.47nF	100	±10%	0.90
3	CL10B102KB85PN □		1.0nF	50	±10%	0.90
4	CL10B102KC85PN □		1.0nF	100	±10%	0.90
5	CL10B222KB85PN □		2.2nF	50	±10%	0.90
6	CL10B222KC85PN □		2.2nF	100	±10%	0.90
7	CL10B472KB85PN □		4.7nF	50	±10%	0.90
8	CL10B472KC85PN □		4.7nF	100	±10%	0.90
9	CL10B103KA85PN □		10nF	25	±10%	0.90
10	CL10B103KB85PN □		10nF	50	±10%	0.90
11	CL10B103KC85PN □		10nF	100	±10%	0.90
12	CL10B153KA85PN □		15nF	25	±10%	0.90
13	CL10B153KB85PN □		15nF	50	±10%	0.90
14	CL10B223KA85PN □		22nF	25	±10%	0.90
15	CL10B223KB85PN □		22nF	50	±10%	0.90
16	CL10B333KA85PN □		33nF	25	±10%	0.90
17	CL10B333KB85PN □		33nF	50	±10%	0.90
18	CL10B473KO85PN □		47nF	16	±10%	0.90
19	CL10B473KA85PN □		47nF	25	±10%	0.90
20	CL10B473KB85PN □		47nF	50	±10%	0.90
21	CL10B683KO85PN □		68nF	16	±10%	0.90
22	CL10B683KA85PN □		68nF	25	±10%	0.90
23	CL10B683KB85PN □		68nF	50	±10%	0.90
24	CL10B104KO85PN □		100nF	16	±10%	0.90
25	CL10B104KA85PN □		100nF	25	±10%	0.90
26	CL10B104KB85PN □		100nF	50	±10%	0.90
27	CL10B154KO84PN □		150nF	16	±10%	0.90
28	CL10B154KA84PN □		150nF	25	±10%	0.90
29	CL10B224KO84PN □		220nF	16	±10%	0.90
30	CL10B224KA84PN □		220nF	25	±10%	0.90
31	CL10B334KO84PN □		330nF	16	±10%	0.90
32	CL10B334KA84PN □		330nF	25	±10%	0.90
33	CL10B474KO84PN □		470nF	16	±10%	0.90
34	CL10B474KA84PN □		470nF	25	±10%	0.90
1	CL21B102KB65PN □	2.00×1.25	1.0nF	50	±10%	0.70
2	CL21B102KC65PN □		1.0nF	100	±10%	0.70
3	CL21B222KB65PN □		2.2nF	50	±10%	0.70
4	CL21B222KC65PN □		2.2nF	100	±10%	0.70
5	CL21B472KB65PN □		4.7nF	50	±10%	0.70
6	CL21B472KC65PN □		4.7nF	100	±10%	0.70
7	CL21B103KB65PN □		10nF	50	±10%	0.70
8	CL21B103KC65PN □		10nF	100	±10%	0.70
9	CL21B153KB65PN □		15nF	50	±10%	0.70
10	CL21B153KC65PN □		15nF	100	±10%	0.70
11	CL21B223KB65PN □		22nF	50	±10%	0.70
12	CL21B223KC65PN □		22nF	100	±10%	0.70
13	CL21B333KBC5PN □		33nF	50	±10%	0.95
14	CL21B333KCC5PN □		33nF	100	±10%	0.95

※ □ mark means packaging code. If you want to learn the code or quantity in detail, please see p80.

Product Lineup (Automotive Capacitors\_X7R)

	Part Number	Size L×W (mm)	Capacitance	Rated Voltage (Vdc)	Capacitance Tolerance	Thickness Max. (mm)
15	CL21B473KAC5PN □	2.00×1.25	47nF	25	±10%	0.95
16	CL21B473KBC5PN □		47nF	50	±10%	0.95
17	CL21B473KCC5PN □		47nF	100	±10%	0.95
18	CL21B683KAC5PN □		68nF	25	±10%	0.95
19	CL21B683KBC5PN □		68nF	50	±10%	0.95
20	CL21B683KCC5PN □		68nF	100	±10%	0.95
21	CL21B104KOC5PN □		100nF	16	±10%	0.95
22	CL21B104KAC5PN □		100nF	25	±10%	0.95
23	CL21B104KBC5PN □		100nF	50	±10%	0.95
24	CL21B104KBF5PN □		100nF	50	±10%	1.35
25	CL21B104KCC5PN □		100nF	100	±10%	0.95
26	CL21B104KCF5PN □		100nF	100	±10%	1.35
27	CL21B154KOF4PN □		150nF	16	±10%	1.35
28	CL21B154KAF4PN □		150nF	25	±10%	1.35
29	CL21B154KBF4PN □		150nF	50	±10%	1.35
30	CL21B224KOF4PN □		220nF	16	±10%	1.35
31	CL21B224KAF4PN □		220nF	25	±10%	1.35
32	CL21B224KBF4PN □		220nF	50	±10%	1.35
33	CL21B334KOF4PN □		330nF	16	±10%	1.35
34	CL21B334KAF4PN □		330nF	25	±10%	1.35
35	CL21B334KBF4PN □		330nF	50	±10%	1.35
36	CL21B474KOF4PN □		470nF	16	±10%	1.35
37	CL21B474KAF4PN □		470nF	25	±10%	1.35
38	CL21B474KBF4PN □		470nF	50	±10%	1.35
39	CL21B684KOF4PN □		680nF	16	±10%	1.35
40	CL21B684KAF4PN □		680nF	25	±10%	1.35
41	CL21B105KOF4PN □		1μF	16	±10%	1.35
42	CL21B105KAF4PN □		1μF	25	±10%	1.35
1	CL31B104KBC5PN □	3.20×1.60	100nF	50	±10%	1.00
2	CL31B154KBP5PN □		150nF	50	±10%	1.25
3	CL31B224KAC5PN □		220nF	25	±10%	1.00
4	CL31B224KBP5PN □		220nF	50	±10%	1.25
5	CL31B334KAC5PN □		330nF	25	±10%	1.00
6	CL31B334KBH5PN □		330nF	50	±10%	1.80
7	CL31B474KAC5PN □		470nF	25	±10%	1.00
8	CL31B474KBH5PN □		470nF	50	±10%	1.80
9	CL31B684KAP5PN □		680nF	25	±10%	1.25
10	CL31B684KBH5PN □		680nF	50	±10%	1.80
11	CL31B105KOP5PN □		1μF	16	±10%	1.25
12	CL31B105KAP5PN □		1μF	25	±10%	1.25
13	CL31B105KBH5PN □		1μF	50	±10%	1.80
14	CL31B155KOH4PN □		1.5μF	16	±10%	1.80
15	CL31B155KAH4PN □		1.5μF	25	±10%	1.80
16	CL31B155KBH4PN □		1.5μF	50	±10%	1.80
17	CL31B225KOH4PN □		2.2μF	16	±10%	1.80
18	CL31B225KAH4PN □		2.2μF	25	±10%	1.80
19	CL31B225KBH4PN □		2.2μF	50	±10%	1.80

※ □mark means packaging code. If you want to learn the code or quantity in detail, please see p80.

Part Numbering System

General Capacitors

High Capacitance Capacitors

Super Small Size Capacitors

Medium-High Voltage Capacitors

Array Type Capacitors

Low ESL Capacitors

Reliability Test Condition

Premium Capacitors for Automotive Applications

Packaging Specification

Application Manual for Surface Mounting



## Reliability Test Condition (Automotive Capacitors)

No	Item	Performance	Test Condition	
1	Pre-and Post-Stress Electrical Test	-		
2	High Temperature Exposure	Appearance	No abnormal exterior appearance	
		Capacitance Change	CLASS I	Within $\pm 2.5\%$ or $0.25\mu\text{F}$ , (Whichever is larger)
			CLASS II	Within $\pm 10\%$
		Q	CLASS I	Capacitance $\geq 30\mu\text{F}$ : $Q \geq 1,000$ $< 30\mu\text{F}$ : $Q \geq 400 + 20 \times C$ (C : Capacitance)
		Tan $\delta$	CLASS II	Rated Voltage $\geq 25\text{V}$ : $0.03$ max $\geq 16\text{V}$ : $0.05$ max $\geq 10\text{V}$ : $0.075$ max
IR		More than $10,000\text{M}\Omega$ or $500\text{M}\Omega \times \mu\text{F}$ (Whichever is smaller)		
3	Temperature Cycling	Appearance	No abnormal exterior appearance	
		Capacitance Change	CLASS I	Within $\pm 2.5\%$ or $0.25\mu\text{F}$ , (Whichever is larger)
			CLASS II	Within $\pm 10\%$
		Q	CLASS I	Capacitance $\geq 30\mu\text{F}$ : $Q \geq 1,000$ $< 30\mu\text{F}$ : $Q \geq 400 + 20 \times C$ (C : Capacitance)
		Tan $\delta$	CLASS II	Rated Voltage $\geq 25\text{V}$ : $0.03$ max $\geq 16\text{V}$ : $0.05$ max $\geq 10\text{V}$ : $0.075$ max
IR		More than $10,000\text{M}\Omega$ or $500\text{M}\Omega \times \mu\text{F}$ (Whichever is smaller)		
4	Destructive Physical Analysis	No defects or abnormalities	Per EIA 469	
5	Moisture Resistance	Appearance	No abnormal exterior appearance	
		Capacitance Change	CLASS I	Within $\pm 2.5\%$ or $0.25\mu\text{F}$ , (Whichever is larger)
			CLASS II	Within $\pm 12.5\%$
		Q	CLASS I	Capacitance $\geq 30\mu\text{F}$ : $Q \geq 350$ $< 10\mu\text{F}$ : $Q \geq 275 + (5/2) \times C$ $< 10\mu\text{F}$ : $Q \geq 200 + 10 \times C$ (C : Capacitance)
		Tan $\delta$	CLASS II	Rated Voltage $\geq 25\text{V}$ : $0.03$ max $\geq 16\text{V}$ : $0.05$ max $\geq 10\text{V}$ : $0.075$ max
IR		More than $10,000\text{M}\Omega$ or $500\text{M}\Omega \times \mu\text{F}$ (Whichever is smaller)		

1000Cycles  
Measurement at  $24 \pm 2$ hrs after test conclusion

Step	Temperature(°C)	Time(min.)
1	Min. operating Temp. $\pm 2$	$15 \pm 3$
2	$25 \pm 2$	1
3	Max. operating Temp. $\pm 2$	$15 \pm 3$
4	$25 \pm 2$	1

10Cycles,  $t=24$ hrs/cycle  
Heat ( $25\sim 65^\circ\text{C}$ ) and humidity ( $80\sim 98\%$ ), Unpowered measurement at  $24 \pm 2$ hrs after test conclusion

Time[Hours]

\* For the more detail Specification, Please refer to the Samsung MLCC catalogue.

No	Item	Performance	Test Condition	
6	Biased Humidity	Appearance	No abnormal exterior appearance	
		Capacitance Change	CLASS I	Within $\pm 2.5\%$ or $0.25\mu\text{F}$ , (Whichever is larger)
			CLASS II	Within $\pm 12.5\%$
		Q	CLASS I	Capacitance $\geq 30\mu\text{F}$ : $Q \geq 200$ $< 30\mu\text{F}$ : $Q \geq 100 + (10/3) \times C$ ( C : Capacitance)
		Tan $\delta$	CLASS II	Rated Voltage $\geq 25\text{V}$ : $0.035$ max $\geq 16\text{V}$ : $0.05$ max $\geq 10\text{V}$ : $0.075$ max
IR		More than $500\text{M}\Omega$ or $25\text{M}\Omega \times \mu\text{F}$ (Whichever is Smaller)		
7	High Temperature Operating Life	Appearance	No abnormal exterior appearance	
		Capacitance Change	CLASS I	Within $\pm 3.0\%$ or $0.3\mu\text{F}$ , (Whichever is larger)
			CLASS II	Within $\pm 12.5\%$
		Q	CLASS I	Capacitance $\geq 30\mu\text{F}$ : $Q \geq 350$ $\geq 10\mu\text{F}$ : $Q \geq 275 + (5/2) \times C$ $< 10\mu\text{F}$ : $Q \geq 200 + 10 \times C$ ( C : Capacitance)
		Tan $\delta$	CLASS II	Rated Voltage $\geq 25\text{V}$ : $0.035$ max $\geq 16\text{V}$ : $0.05$ max $\geq 10\text{V}$ : $0.075$ max
IR		More than $1,000\text{M}\Omega$ or $50\text{M}\Omega \times \mu\text{F}$ (Whichever is smaller)		
8	External Visual	No abnormal exterior appearance	Microscope (x10)	
9	Physical Dimensions	Within the specified dimensions	Using the calipers	
10	Mechanical Shock	Appearance	No abnormal exterior appearance	
		Capacitance Change	CLASS I	Within $\pm 2.5\%$ or $0.25\mu\text{F}$ , (Whichever is larger)
			CLASS II	Within $\pm 10\%$
		Q	CLASS I	Capacitance $\geq 30\mu\text{F}$ : $Q \geq 1,000$ $< 30\mu\text{F}$ : $Q \geq 400 + 20 \times C$ ( C : Capacitance)
		Tan $\delta$	CLASS II	Rated Voltage $\geq 25\text{V}$ : $0.025$ max $\geq 16\text{V}$ : $0.035$ max $\geq 10\text{V}$ : $0.05$ max
IR		More than $10,000\text{M}\Omega$ or $500\text{M}\Omega \times \mu\text{F}$ (Whichever is smaller)		

Peakvalue	Duration	Wave
1,500G	0.5ms	Half sine

\* For the more detail Specification, Please refer to the Samsung MLCC catalogue.

- Part Numbering System
- General Capacitors
- High Capacitance Capacitors
- Super Small Size Capacitors
- Medium-High Voltage Capacitors
- Array Type Capacitors
- Low ESL Capacitors
- Reliability Test Condition
- Premium Capacitors for Automotive Applications
- Packaging Specification
- Application Manual for Surface Mounting



No	Item	Performance	Test Condition	
11	Vibration	Appearance	No abnormal exterior appearance	
		Capacitance Change	CLASS I	Within $\pm 2.5\%$ or $0.25\text{pF}$ , (Whichever is larger)
			CLASS II	Within $\pm 10\%$
		Q	CLASS I	Capacitance $\geq 30\text{pF}$ : $Q \geq 1,000$ < $30\text{pF}$ : $Q \geq 400 + 20 \times C$ ( C : Capacitance)
		Tan $\delta$	CLASS II	Rated Voltage $\geq 25\text{V}$ : $0.025$ max $\geq 16\text{V}$ : $0.035$ max $\geq 10\text{V}$ : $0.05$ max
IR		More than $10,000\text{M}\Omega$ or $500\text{M}\Omega \times \mu\text{F}$ (Whichever is smaller)		
12	Resistance to Solder Heat	Appearance	No abnormal exterior appearance	
		Capacitance Change	CLASS I	Within $\pm 2.5\%$ or $0.25\text{pF}$ , (Whichever is larger)
			CLASS II	Within $\pm 10\%$
		Q	CLASS I	Capacitance $\geq 30\text{pF}$ : $Q \geq 1,000$ < $30\text{pF}$ : $Q \geq 400 + 20 \times C$ ( C : Capacitance)
		Tan $\delta$	CLASS II	Rated Voltage $\geq 25\text{V}$ : $0.025$ max $\geq 16\text{V}$ : $0.035$ max $\geq 10\text{V}$ : $0.05$ max
IR		More than $10,000\text{M}\Omega$ or $500\text{M}\Omega \times \mu\text{F}$ (Whichever is smaller)		
13	Thermal Shock	Appearance	No abnormal exterior appearance	
		Capacitance Change	CLASS I	Within $\pm 2.5\%$ or $0.25\text{pF}$ , (Whichever is larger)
			CLASS II	Within $\pm 10\%$
		Q	CLASS I	Capacitance $\geq 30\text{pF}$ : $Q \geq 1,000$ < $30\text{pF}$ : $Q \geq 400 + 20 \times C$ ( C : Capacitance)
		Tan $\delta$	CLASS II	Rated Voltage $\geq 25\text{V}$ : $0.025$ max $\geq 16\text{V}$ : $0.035$ max $\geq 10\text{V}$ : $0.05$ max
IR		More than $10,000\text{M}\Omega$ or $500\text{M}\Omega \times \mu\text{F}$ (Whichever is smaller)		
14	ESD	Appearance	No abnormal exterior appearance	
		Capacitance Change	CLASS I	Within $\pm 2.5\%$ or $0.25\text{pF}$ , (Whichever is larger)
			CLASS II	Within $\pm 10\%$
		Q	CLASS I	Capacitance $\geq 30\text{pF}$ : $Q \geq 1,000$ < $30\text{pF}$ : $Q \geq 400 + 20 \times C$ ( C : Capacitance)
		Tan $\delta$	CLASS II	Rated Voltage $\geq 25\text{V}$ : $0.025$ max $\geq 16\text{V}$ : $0.035$ max $\geq 10\text{V}$ : $0.05$ max
IR		More than $10,000\text{M}\Omega$ or $500\text{M}\Omega \times \mu\text{F}$ (Whichever is smaller)		

\* For the more detail Specification, Please refer to the Samsung MLCC catalogue.

No	Item	Performance	Test Condition																				
15	Solderability	95% of the terminations is to be soldered evenly and continuously	a) Preheat at 155 °C for 4 hours, Immerse in solder for 5s at 235 ± 5 °C b) Steam aging for 8 hours, Immerse in solder for 5s at 235 ± 5 °C c) Steam aging for 8 hours, Immerse in solder for 120s at 260 ± 5 °C solder : a solution ethanol and rosin																				
16	Electrical Characterization	Capacitance	Within specified tolerance																				
		Q	CLASS I Capacitance ≥ 30pF : Q ≥ 1,000 < 30pF : Q ≥ 400 + 20 × C (C: Capacitance)																				
		Tanδ	CLASS II Rated Voltage ≥ 25V : 0.025 max ≥ 16V : 0.035 max ≥ 10V : 0.05max																				
		IR@25 °C	CLASS I	More than 100,000MΩ or 1,000MΩ × μF (Whichever is smaller)																			
			CLASS II	More than 10,000MΩ or 500MΩ × μF (Whichever is smaller)																			
		IR@125 °C	CLASS I	More than 10,000MΩ or 100MΩ × μF (Whichever is smaller)																			
CLASS II	More than 1,000MΩ or 10MΩ × μF (Whichever is smaller)																						
Dielectric Strength	No dielectric breakdown or mechanical breakdown																						
			The Capacitance /D.F. should be measured at 25 °C, <table border="1"> <thead> <tr> <th>Class</th> <th>Capacitance</th> <th>Frequency</th> <th>Vrms</th> </tr> </thead> <tbody> <tr> <td>Class I</td> <td>1000pF ↓</td> <td>1 MHz ± 10%</td> <td>0.5~5Vrms</td> </tr> <tr> <td>Class I</td> <td>1000pF ↑</td> <td>1 KHz ± 10%</td> <td>1.0 ± 0.2Vrms</td> </tr> <tr> <td>Class II</td> <td>10 μF ↓</td> <td>1 KHz ± 10%</td> <td>1.0 ± 0.2Vrms</td> </tr> <tr> <td>Class II</td> <td>10 μF ↑</td> <td>120 Hz ± 20%</td> <td>0.5 ± 0.1Vrms</td> </tr> </tbody> </table> I.R. should be measured with a DC voltage not exceeding Rated Voltage @25 °C, @125 °C for 60~120 sec. Dielectric Strength : 250% of the rated voltage for 1~5 seconds The charge/discharge current is less than 50mA.	Class	Capacitance	Frequency	Vrms	Class I	1000pF ↓	1 MHz ± 10%	0.5~5Vrms	Class I	1000pF ↑	1 KHz ± 10%	1.0 ± 0.2Vrms	Class II	10 μF ↓	1 KHz ± 10%	1.0 ± 0.2Vrms	Class II	10 μF ↑	120 Hz ± 20%	0.5 ± 0.1Vrms
Class	Capacitance	Frequency	Vrms																				
Class I	1000pF ↓	1 MHz ± 10%	0.5~5Vrms																				
Class I	1000pF ↑	1 KHz ± 10%	1.0 ± 0.2Vrms																				
Class II	10 μF ↓	1 KHz ± 10%	1.0 ± 0.2Vrms																				
Class II	10 μF ↑	120 Hz ± 20%	0.5 ± 0.1Vrms																				
17	Board Flex	Appearance	No abnormal exterior appearance																				
		Capacitance Change	CLASS I	Within ± 5.0% or 0.5pF, (Whichever is larger)																			
			CLASS II	Within ± 10%																			
			Bending to the limit for 5 seconds Limit : Class I - 3mm Class II - 2mm																				
18	Terminal Strength(SMD)	Appearance	No abnormal exterior appearance																				
		Capacitance Change	CLASS I	Within ± 2.5% or 0.25pF, (Whichever is larger)																			
			CLASS II	Within ± 10%																			
			18N, for 60 ± 1 sec. * 0603(1608) - 10N, 0402(1005) - 2N																				
19	Beam Load	Destruction value should be exceed Chip Length ≤ 2.5mm a) Chip Thickness > 0.5mm : 20N b) Chip Thickness ≤ 0.5mm : 8N Chip Length ≥ 3.2mm a) Chip Thickness ≥ 1.25mm : 54.5N b) Chip Thickness < 1.25mm : 15N	Beam speed Chip Length ≤ 2.5mm, 0.5 ± 0.05mm/sec Chip Length ≥ 3.2mm, 2.5 ± 0.25mm/sec																				
20	Capacitance Temperature Characteristics	Capacitance Change	CLASS I	0 ± 30 ppm/°C																			
			CLASS II	Within ± 15%																			
		Temperature Coefficient	CLASS I	0 ± 30 ppm/°C																			
		Capacitance Drift	CLASS I	Within ± 0.2% or 0.05pF, (Whichever is larger)																			
						<table border="1"> <thead> <tr> <th>Step</th> <th>Temperature(°C)</th> <th>Time(min)</th> </tr> </thead> <tbody> <tr> <td>1</td> <td>25 ± 2</td> <td>1</td> </tr> <tr> <td>2</td> <td>Min. Operating Temp. ± 2</td> <td>15 ± 3</td> </tr> <tr> <td>3</td> <td>25 ± 2</td> <td>1</td> </tr> <tr> <td>4</td> <td>Max. Operating Temp. ± 2</td> <td>15 ± 3</td> </tr> <tr> <td>5</td> <td>25 ± 2</td> <td>1</td> </tr> </tbody> </table>	Step	Temperature(°C)	Time(min)	1	25 ± 2	1	2	Min. Operating Temp. ± 2	15 ± 3	3	25 ± 2	1	4	Max. Operating Temp. ± 2	15 ± 3	5	25 ± 2
Step	Temperature(°C)	Time(min)																					
1	25 ± 2	1																					
2	Min. Operating Temp. ± 2	15 ± 3																					
3	25 ± 2	1																					
4	Max. Operating Temp. ± 2	15 ± 3																					
5	25 ± 2	1																					

\* For the more detail Specification, Please refer to the Samsung MLCC catalogue.

- Part Numbering System
- General Capacitors
- High Capacitance Capacitors
- Super Small Size Capacitors
- Medium-High Voltage Capacitors
- Array Type Capacitors
- Low ESL Capacitors
- Reliability Test Condition
- Premium Capacitors for Automotive Applications
- Packaging Specification
- Application Manual for Surface Mounting

# Packaging Specifications

## Cardboard Paper Tape(4mm)

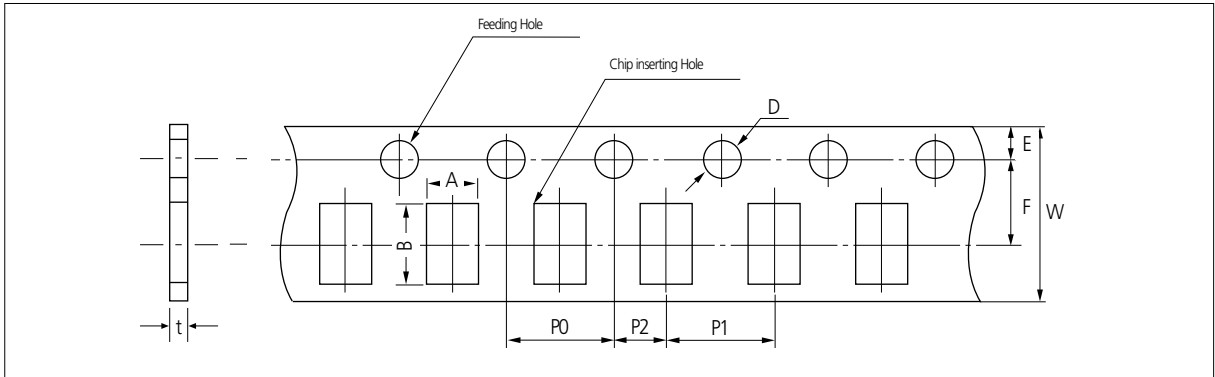

Unit: inch(mm)

Symbol		A	B	W	F	E	P1	P2	P0	D	t
Type											
Dimension	0504 (1410)	1.3 ±0.2	1.7 ±0.2	8.0 ±0.3	3.5 ±0.05	1.75 ±0.1	4.0 ±0.1	2.0 ±0.05	4.0 ±0.1	Ø1.5 +0.1/-0	1.1 Below
	0603 0306 (1608) (0816)	1.1 ±0.2	1.9 ±0.2								
	0805 0508 (2012) (1220)	1.6 ±0.2	2.4 ±0.2								
	1206 0612 (3216) (1632)	2.0 ±0.2	3.6 ±0.2								

## Cardboard Paper Tape(2mm)

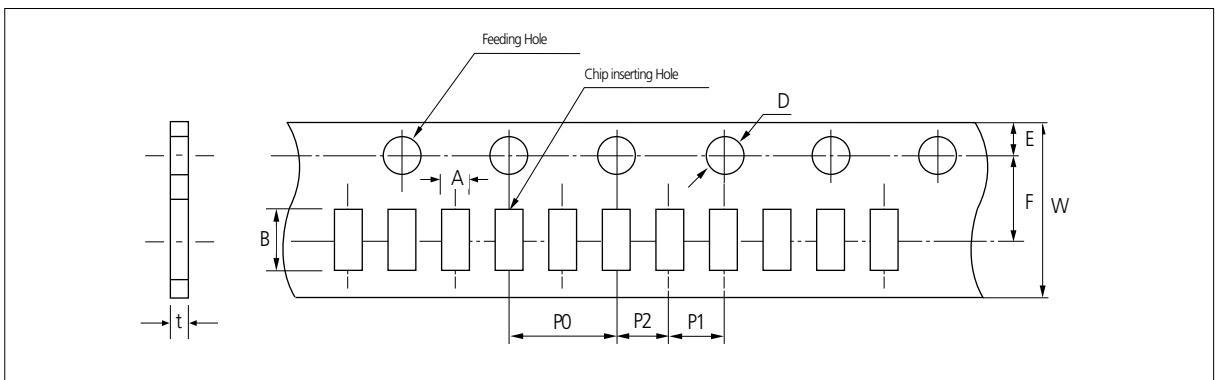

Unit: inch(mm)

Symbol		A	B	W	F	E	P1	P2	P0	D	t
Type											
Dimension	01005 (0402)	0.26 ±0.03	0.46 ±0.03	8.0 ±0.3	3.5 ±0.05	1.75 ±0.1	2.0 ±0.05	2.0 ±0.05	4.0 ±0.1	Ø1.550 ±0.02	0.26 ±0.03
	0201 (0603)	0.38 ±0.03	0.68 ±0.03								
	0402 (1005)	0.62 ±0.04	1.12 ±0.04								

## Embossed Plastic Tape

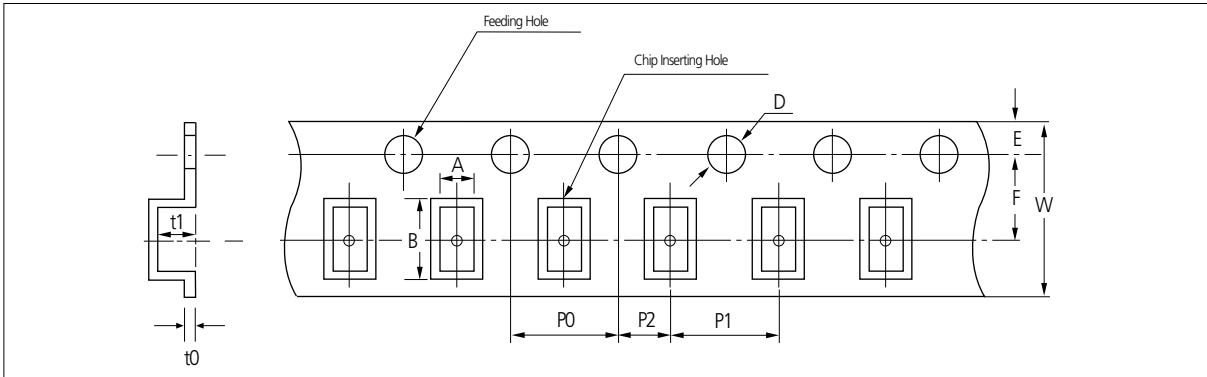

Unit: inch(mm)

Symbol Type		A	B	W	F	E	P1	P2	P0	D	t1	t0
Dimension	0603 (1608)	1.05 ±0.15	1.9 ±0.15	8.0 ±0.3	3.5 ±0.05	1.75 ±0.1	4.0 ±0.1	2.0 ±0.05	4.0 ±0.1	Ø1.5 +0.1/ -0	2.8 max	0.6 BELOW
	0805 (2012)	1.45 ±0.2	2.3 ±0.2									
	1206 0612 (3216) (1632)	1.9 ±0.2	3.5 ±0.2									
	1210 (3225)	2.8 ±0.2	3.6 ±0.2									
	1808 (4520)	2.3 ±0.2	4.9 ±0.2									
	1812 (4532)	3.6 ±0.2	4.9 ±0.2	12.0 ±0.3	5.60 ±0.05		8.0 ±0.1					
	2220 (5750)	5.5 ±0.2	6.2 ±0.2									

Part Numbering System

General Capacitors

High Capacitance Capacitors

Super Small Size Capacitors

Medium-High Voltage Capacitors

Array Type Capacitors

Low ESL Capacitors

Reliability Test Condition

Premium Capacitors for Automotive Applications

Packaging Specification

Application Manual for Surface Mounting

## Peeling off of Cover Tape

- $5 \text{ g.f} \leq \text{Peel off force} \leq 70 \text{ g.f}$

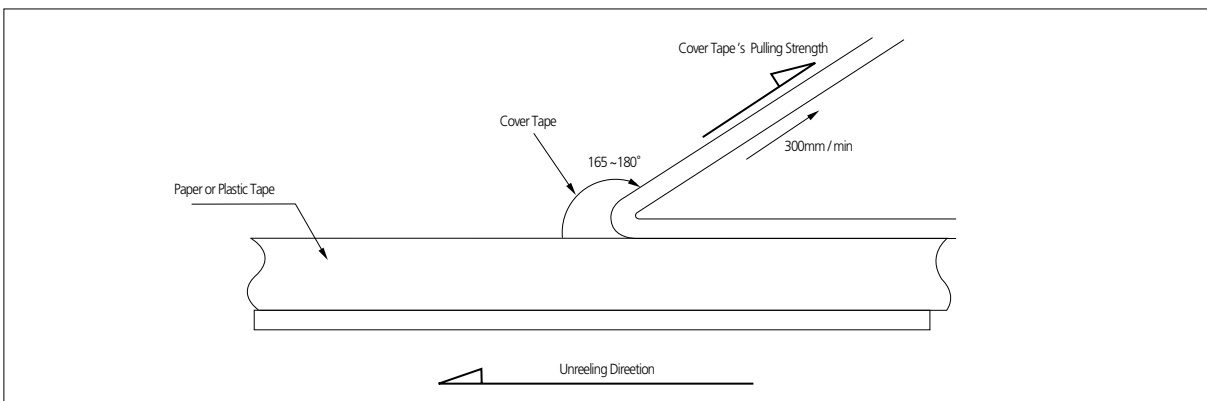





## Reel Dimensions

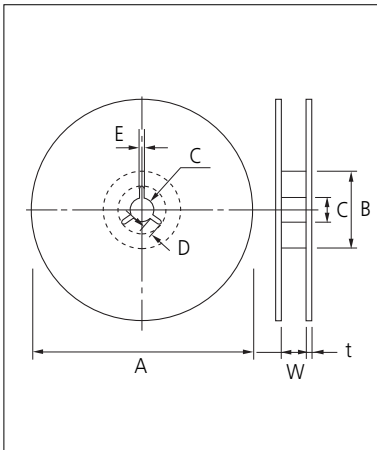

Unit: mm

Symbol	Tape Width	A	B	C	D
7" Reel	8mm	$\varnothing 180+0/-3$	$\varnothing 60+1/-0$	$\varnothing 13\pm 0.3$	$4\pm 0.2$
	12mm	$\varnothing 180+0/-3$	$\varnothing 60+1/-0$	$\varnothing 13\pm 0.3$	$4\pm 0.2$
10" Reel	8mm	$\varnothing 258+0/-3$	$\varnothing 80+1/-0$	$\varnothing 13\pm 0.3$	$4\pm 0.2$
	12mm	$\varnothing 258+0/-3$	$\varnothing 80+1/-0$	$\varnothing 13\pm 0.3$	$4\pm 0.2$
13" Reel	8mm	$\varnothing 330\pm 2.0$	$\varnothing 80\pm 1.0$	$\varnothing 13\pm 0.3$	$4\pm 0.2$
	12mm	$\varnothing 330\pm 2.0$	$\varnothing 80\pm 1.0$	$\varnothing 13\pm 0.3$	$4\pm 0.2$

Symbol	Tape Width	E	W	t
7" Reel	8mm	$2.0\pm 0.5$	$9\pm 0.5$	$1.2\pm 0.2$
	12mm	$2.0\pm 0.5$	$13\pm 0.5$	$1.2\pm 0.2$
10" Reel	8mm	$2.0\pm 0.5$	$9\pm 0.5$	$1.8\pm 0.2$
	12mm	$2.0\pm 0.5$	$13\pm 0.5$	$1.8\pm 0.2$
13" Reel	8mm	$2.0\pm 0.5$	$9\pm 0.5$	$2.2\pm 0.2$
	12mm	$2.0\pm 0.5$	$13\pm 0.5$	$2.2\pm 0.2$

## Bulk Case Packaging

- Bulk case packaging can reduce the stock space and transportation costs.
- The bulk feeding system can increase the productivity.
- It can eliminate the components loss.

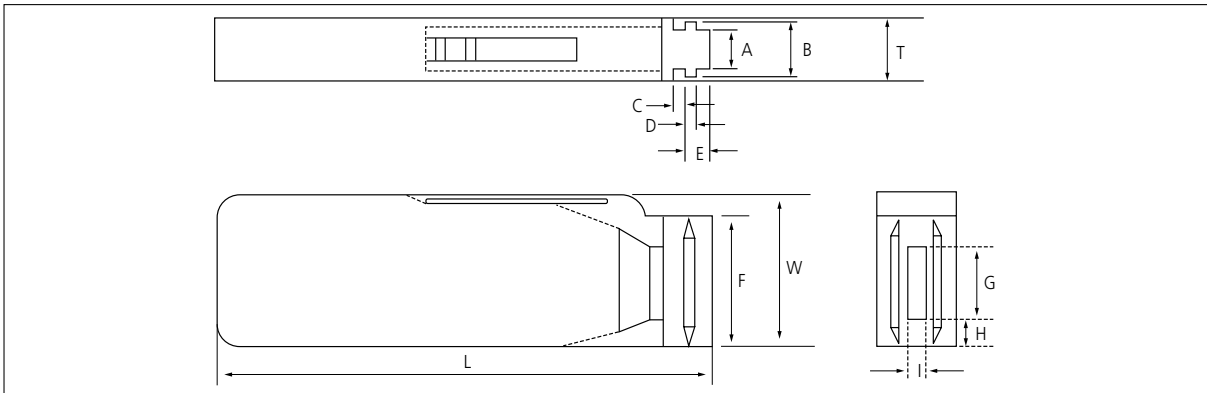

Unit: mm

Symbol	A	B	T	C	D	E
Dimension	$6.8\pm 0.1$	$8.8\pm 0.1$	$12\pm 0.1$	$1.5+0.1/-0$	$2+0/-0.1$	$3.0+0.2/-0$

Symbol	F	W	G	H	L	I
Dimension	$31.5+0.2/-0$	$36+0/-0.2$	$19\pm 0.35$	$7\pm 0.35$	$110\pm 0.7$	$5\pm 0.35$

### • QUANTITY

Unit: inch(mm) and pcs

Size	0402(1005)	0603(1608)	0805(2012)	
			T=0.65mm	T=0.85mm
Quantity	50,000	10,000 or 15,000	10,000	5,000 or 10,000

Part Numbering System

General Capacitors

High Capacitance Capacitors

Super Small Size Capacitors

Medium-High Voltage Capacitors

Array Type Capacitors

Low ESL Capacitors

Reliability Test Condition

Premium Capacitors for Automotive Applications

Packaging Specification

Application Manual for Surface Mounting

# Application Manual for Surface Mounting

## 1.Storage of products

### 1-1. Storage Environment

Tape packing materials are designed to withstand long-term storage, but they will degrade more rapidly in the presence of high temperature or high humidity, Therefore, the products must be stored in an ambient 5~40°C with a relative humidity of 20~70%. Allowable storage period is within 6 months from the outgoing date of delivery.

### 1-2. Corrosive Gases

Since sulfur and chlorine may degrade the solderability of the end termination, it is important to store the capacitors in an environment free of these gases

### 1-3. Temperature Fluctuations

Since dew condensation may occur by the differences in temperature when the products are taken out of storage, it is important to maintain a temperature-controlled environment.

## 2.Design of Solder Land Pattern

When designing printed circuit boards, the shape and size of the solder lands must allow for the proper amount of solder on the capacitor. The amount of solder at the end terminations has a direct effect on the probability that the chip will crack. The greater amount of solder, the larger amount of stress on the chip, and the more likely that it will break. Use the following illustrations as guidelines for proper Solder land design.

Recommendation of solder Land Shape and Size

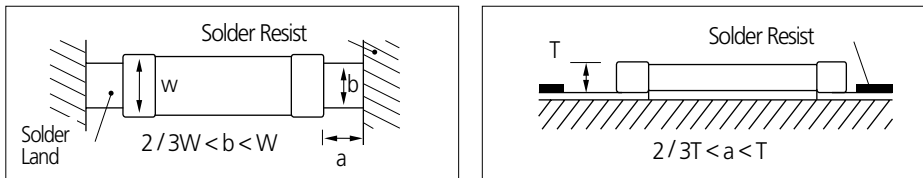

## 3.Adhesives

MLCCs generally require the use of an adhesive to position the chips to the circuit board prior to soldering.

### 3-1. Requirements for Adhesives

- They must have enough adhesion so that the chips will not fall off or move during the handling of the circuit board.
- They must maintain their adhesive strength when exposed to soldering temperatures.
- They should not spread or run when applied to the circuit board.
- They should have a long pot life.
- They should harden quickly.
- They should not corrode the circuit board or chip material.
- They should be a good insulator.
- They should be non-toxic, and not produce harmful gases, nor be harmful when touched.

### 3-2. Application Method

It is important to use the proper amount of adhesive. Too little will cause poor adhesion to the circuit board, and too much may strain the conductor pattern, thereby causing defective soldering. The following illustrations show the proper quantity of adhesive.

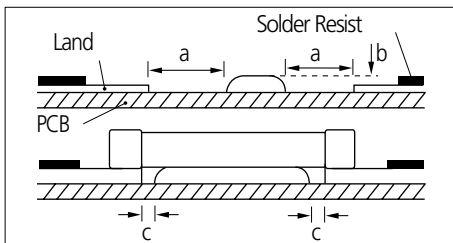

Unit: mm		
Type	21	31
a	0.2min	0.2min
b	70~100μm	70~100μm
c	>0	>0

### 3-3. Adhesive hardening Characteristics

To prevent oxidation of the terminations, the adhesive must harden at 160°C or less, within 2 minutes or less.

## 4. Mounting

### 4-1. Mounting Head Pressure

Excessive pressure will cause chip capacitors to crack. The pressure between nozzle and chip capacitor will be 300g maximum during mounting.

### 4-2. Bending Stress

Bending of printed circuit board by mounting head when double-sided circuit boards are used, chip capacitors first are mounted and soldered onto one side of the board. When the capacitors are mounted onto the other side, it is important to support the board as shown in the illustration. If the circuit board is not supported, it may bend, causing the already-installed capacitors to crack.

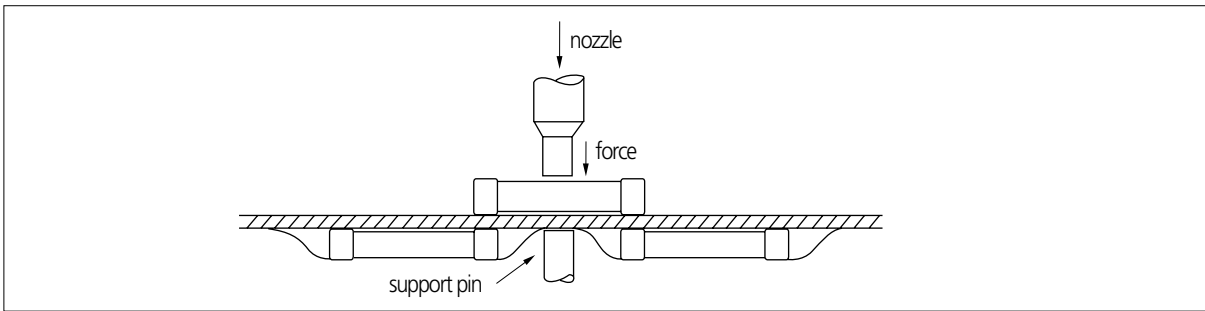

Part Numbering System

General Capacitors

High Capacitance Capacitors

Super Small Size Capacitors

Medium-High Voltage Capacitors

Array Type Capacitors

Low ESL Capacitors

Reliability Test Condition

Premium Capacitors for Automotive Applications

Packaging Specification

Application Manual for Surface Mounting

## 5. Flux

Although highly-activated flux gives better solderability, substances which increase activity may also degrade the insulation of the chip capacitors, To avoid such degradation, it is recommended that a mildly activated rosin flux ( less than 0.2% chlorine ) be used.

## 6. Soldering

Since a multilayer ceramic chip capacitor comes into direct contact with melted solder during soldering, it is exposed to potentially mechanical stress caused by the sudden temperature change. The capacitor may also be subject to silver migration, and to contamination by the flux. Because of these factors, soldering technique is critical.

### 6-1. Soldering Methods

Method	Classification	
Reflow soldering	· Overall heating	· Infrared rays · Hot plate · VPS (Vapor phase)
	· Local heating	· Air heater · Laser · Light beam
Flow Soldering	· Single wave · Double wave	

### 6-2. Soldering Profile

To avoid the crack problem by sudden temperature change, follow the temperature profile in the adjacent graph.

**6-2-1 Pb-Free (Sn 100%) Plating**

▪ **REFLOW SOLDERING**

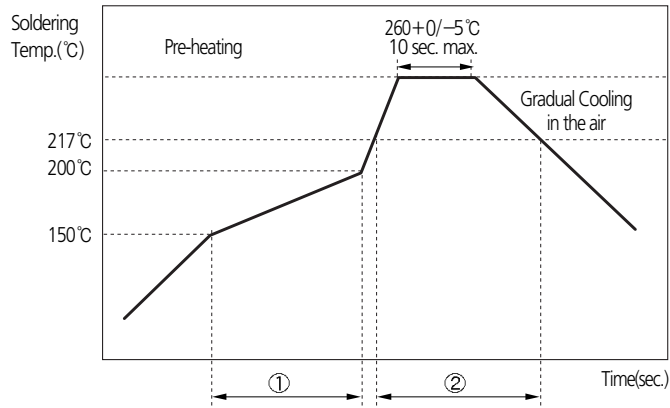

Soldering Temp. (°C)	Pre-heating Time (①, sec.)	Soldering Time (②, sec.)
260+0/-5°C	60~120	60~150

▪ **FLOW SOLDERING**

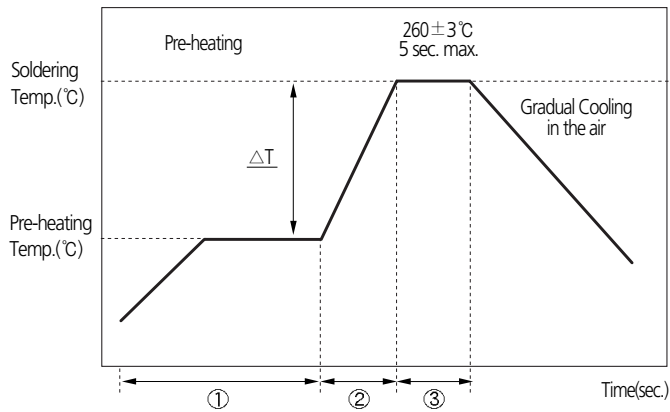

$\Delta T$ (°C)	Soldering Temp. (°C)	Pre-heating Time (①+②, sec.)	Soldering Time (③, sec.)
$\leq 150$ (1206 and below size)	260±3	$\geq 120$	$\leq 5$

▪ **SOLDER IRON(Hand Soldering)**

Variation of Temp.(°C)	Soldering Temp(°C)	Pre-heating Time(sec.)	Soldering Time(sec.)	Cooling Time(sec.)	Condition of Iron Facilities		
					Wattage	Tip Diameter	Soldering Time
$\Delta T \leq 130$	300±10°C max.	$\geq 60$ sec.	$\leq 4$ sec.	-	20W max.	3mm max.	4 sec max.

※ Caution - Iron tip should not contact with ceramic body directly

### 6-3. Manual Soldering

Manual soldering can pose a great risk of creating thermal cracks in chip capacitors. The hot soldering iron tip comes into direct contact with the end terminations, and operator's carelessness may cause the tip of the soldering iron to come into direct contact with the ceramic body of the capacitor. Therefore the soldering iron must be handled carefully, and close attention must be paid to the selection of the soldering iron tip and to temperature control of the tip.

### 6-4. Amount of Solder

Too much Solder		Cracks tend to occur due to large stress.
Not enough solder		Weak holding force may cause bad connections or detaching of the capacitor

### 6-5. Cooling

Natural cooling using air is recommended. If the chips are dipped into solvent for cleaning, the temperature difference ( $\Delta T$ ) must be less than 100°C

### 6-6. Cleaning

If rosin flux is used, cleaning usually is unnecessary. When strongly activated flux is used, chlorine in the flux may dissolve into some types of cleaning fluids, thereby affecting the chip capacitors. This means that the cleaning fluid must be carefully selected, and should always be new.

## 7. Notes for Separating Multiple, Shared PC Boards

A multi-PC board is separated into many individual circuit boards after soldering has been completed. If the board is bent or distorted at the time of separation, cracks may occur in the chip capacitors. Carefully choose a separation method that minimizes the bending of the circuit board.

Part Numbering System

General Capacitors

High Capacitance Capacitors

Super Small Size Capacitors

Medium-High Voltage Capacitors

Array Type Capacitors

Low ESL Capacitors

Reliability Test Condition

Premium Capacitors for Automotive Applications

Packaging Specification

Application Manual for Surface Mounting



**SAMSUNG**  
**ELECTRO-MECHANICS**



**Sony Green Partner**

**Certificate  
Green Partner**

Presented To: **SKD 5431**  
**Samsung Japan Corporation**  
**SAMSUNG ELECTRO-MECHANICS CO., LTD. SUWON FACTORY**  
 This is to certify that you have successfully established an environmental management system that meets the requirements of the Sony Green Partner Program.  
 Term of Validity: 2010/6/1 ~ 2012/5/31  
 Issued on: 2010/5/31  
 Approved and issued by: Procurement Group, Sony Corporation

**SONY**

87574

**ISO/TS 16949**

**Certificate  
of Registration**

QUALITY MANAGEMENT SYSTEM - ISO/TS 16949:2002

This is to certify that **Samsung Electro-Mechanics Co., Ltd.** is in conformity with the requirements of ISO/TS 16949:2002 for the design and manufacture of multi-layer ceramic capacitors.

Permitted Exclusion: None

Original registration: 2010/05/31  
 Valid until: 2012/05/31  
 Issued on: 2010/05/31



**ISO 14001**

**ENVIRONMENTAL MANAGEMENT SYSTEM CERTIFICATE**

Registration No. 0210021014302L

This is to certify that the environmental management system of **Samsung High Tech Electro-mechanics (Tianjin) Co., Ltd.** is in conformity with GB/T24001-2004 / ISO14001:2004.

This certificate is valid for the following scope: **Chip-resistor, Light Emitting Diode, Image Sensor Module Production Manage Activity because is involved.**

This certificate is valid from April 26, 2009 to April 27, 2012.



**OHSAS18001**

**Certificate  
of Registration**

Occupational Health and Safety Management

This is to certify that **Samsung Electro-Mechanics Co., Ltd.** is in conformity with the requirements of OHSAS 18001:2007 for the following scope: **The manufacture of computer peripheral, network products and components for general, mobile communication, computer, video audio.**

The manufacture of HDHigh Density Interconnection, MLC/DWDR Laser Diode components, MCM/MLA Laser Chip Drivers, FOD/OL Chip Driver Array, (D)Image Sensor Module and FPCB/Flexible Printed circuit Board.

Original registration: 2010/05/31  
 Valid until: 2012/05/31  
 Issued on: 2010/05/31



**Quality System Certification status for each factory site**

Certification	Suwon (Korea)	Busan (Korea)	Calamba (Philippines)	Tianjin (China)	Gaoxin (China)
ISO / TS 16949	BSI TS 91430-000 [Nov.22.2010]		BSI TS 91430-005 [Aug.13.2012]	BSI TS 91430-007 [Dec.04.2011]	BSI TS 91430-008 [Dec.04.2011]
TL 9000	-	BSI FM90588 [Sep.21.2011]	-	-	-
ISO 14001	UL 20003847 UM [Jap. 14.2011]		BSI EMS 77354 [Aug.03.2012]	CCCI 02107E10192R3L [Jul.23.2010]	CCCI 02109E10143R2L [Apr.27.2012]
OSHAS 18001	UL 20003847 BSOH [Jul.24.2010]		SGS PH08/0220 [Mar.16.2011]	CCCI 02109S10089R2L [Apr.27.2009]	CCCI 02109S10088R2L [Apr.27.2012]
Sony Green Partner	Sony SKD 5431 [June.01.2010 May~31.2012]	Sony SKD 5432 [June.01.2010 May~31.2012]	Sony SKD 5434 [June.01.2010 May~31.2012]	Sony SKD 5437 [June.01.2010 May~31.2012]	