

MITSUBISHI IGBT MODULES  
**CM150DY-34A**

HIGH POWER SWITCHING USE

**CM150DY-34A**



- IC ..... 150A
- VCES ..... 1700V
- Insulated Type
- 2-elements in a pack

**APPLICATION**

General purpose inverters & Servo controls, etc

**OUTLINE DRAWING & CIRCUIT DIAGRAM**

Dimensions in mm

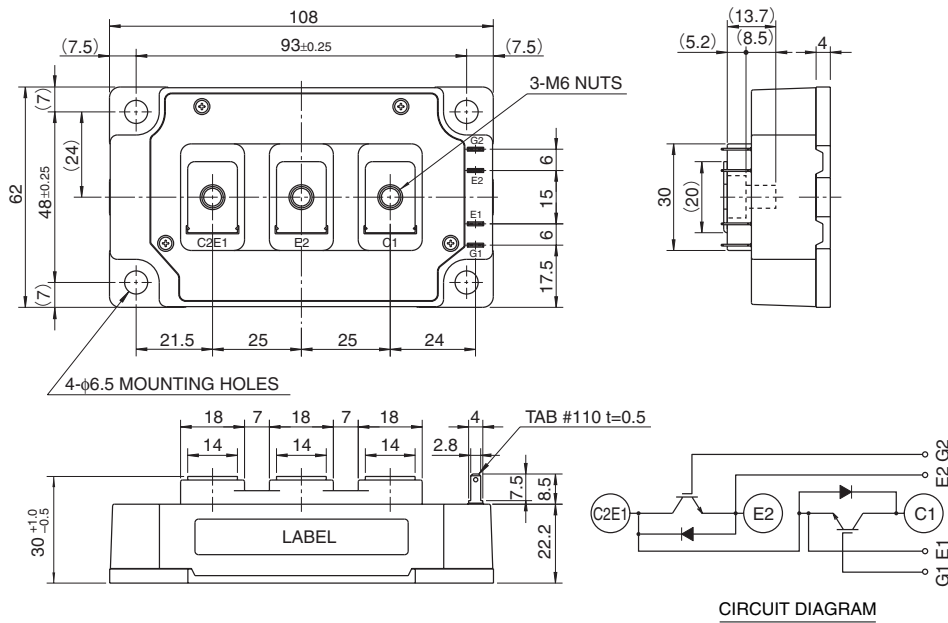

CM150DY-34A

HIGH POWER SWITCHING USE

**ABSOLUTE MAXIMUM RATINGS** (T<sub>J</sub> = 25°C, unless otherwise specified)

Symbol	Parameter	Conditions	Ratings	Unit
V <sub>CE</sub> S	Collector-emitter voltage	G-E Short	1700	V
V <sub>GE</sub> S	Gate-emitter voltage	C-E Short	±20	V
I <sub>C</sub>	Collector current	DC, T <sub>C</sub> = 112°C <sup>*1</sup>	150	A
I <sub>CM</sub>		Pulse	300	
I <sub>E</sub> (Note 1)	Emitter current	Operation	150	A
I <sub>EM</sub> (Note 1)		Pulse	300	
P <sub>C</sub> (Note 3)	Maximum collector dissipation	T <sub>C</sub> = 25°C <sup>*1</sup>	1600	W
T <sub>J</sub>	Junction temperature		-40 ~ +150	°C
T <sub>stg</sub>	Storage temperature		-40 ~ +125	°C
V <sub>iso</sub>	Isolation voltage	Main terminal to base plate, AC 1 min.	3500	V
—	Torque strength	Main terminal M6	3.5 ~ 4.5	N • m
—		Mounting holes M6	3.5 ~ 4.5	
—	Weight	Typical value	400	g

**ELECTRICAL CHARACTERISTICS** (T<sub>J</sub> = 25°C, unless otherwise specified)

Symbol	Parameter	Test conditions	Limits			Unit
			Min.	Typ.	Max.	
I <sub>CES</sub>	Collector cutoff current	V <sub>CE</sub> = V <sub>CE</sub> S, V <sub>GE</sub> = 0V	—	—	1	mA
V <sub>GE(th)</sub>	Gate-emitter threshold voltage	I <sub>C</sub> = 15mA, V <sub>CE</sub> = 10V	5.5	7.0	8.5	V
I <sub>GES</sub>	Gate leakage current	±V <sub>GE</sub> = V <sub>GES</sub> , V <sub>CE</sub> = 0V	—	—	2.0	μA
V <sub>CE(sat)</sub>	Collector to emitter saturation voltage	T <sub>J</sub> = 25°C	—	2.2	2.8	V
		T <sub>J</sub> = 125°C	I <sub>C</sub> = 150A, V <sub>GE</sub> = 15V	—	2.45	
C <sub>ies</sub>	Input capacitance	V <sub>CE</sub> = 10V V <sub>GE</sub> = 0V	—	—	37	nF
C <sub>oes</sub>	Output capacitance		—	—	4.2	
C <sub>res</sub>	Reverse transfer capacitance		—	—	0.8	
Q <sub>G</sub>	Total gate charge	V <sub>CC</sub> = 1000V, I <sub>C</sub> = 150A, V <sub>GE</sub> = 15V	—	1000	—	nC
t <sub>d(on)</sub>	Turn-on delay time	V <sub>CC</sub> = 1000V, I <sub>C</sub> = 150A V <sub>GE1</sub> = V <sub>GE2</sub> = 15V R <sub>G</sub> = 3.2Ω, Inductive load switching operation I <sub>E</sub> = 150A	—	—	550	ns
t <sub>r</sub>	Turn-on rise time		—	—	190	
t <sub>d(off)</sub>	Turn-off delay time		—	—	750	
t <sub>f</sub>	Turn-off fall time		—	—	350	
t <sub>rr</sub> (Note 1)	Reverse recovery time		—	—	450	
Q <sub>rr</sub> (Note 1)	Reverse recovery charge		—	15	—	μC
V <sub>EC</sub> (Note 1)	Emitter-collector voltage	I <sub>E</sub> = 150A, V <sub>GE</sub> = 0V	—	—	3.0	V
R <sub>th(j-c)Q</sub>	Thermal resistance	IGBT part (1/2 module) <sup>*1</sup>	—	—	0.078	°C/W
R <sub>th(j-c)R</sub>		FWDi part (1/2 module) <sup>*1</sup>	—	—	0.15	
R <sub>th(c-f)</sub>	Contact thermal resistance	Case to fin, Thermal compound applied (1/2 module) <sup>*1,*2</sup>	—	0.02	—	
R <sub>G</sub>	External gate resistance		3.2	—	32	Ω

\*1 : T<sub>C</sub>, T<sub>f</sub> measured point is just under the chips.

\*2 : Typical value is measured by using Shin-Etsu Chemical Co.,Ltd "G-746".

Note 1. I<sub>E</sub>, I<sub>EM</sub>, V<sub>EC</sub>, t<sub>rr</sub> & Q<sub>rr</sub> represent characteristics of the anti-parallel, emitter to collector free-wheel diode (FWDi).

2. Pulse width and repetition rate should be such that the device junction temperature (T<sub>J</sub>) does not exceed T<sub>Jmax</sub> rating.

3. Junction temperature (T<sub>J</sub>) should not increase beyond 150°C.

4. Pulse width and repetition rate should be such as to cause negligible temperature rise.

PERFORMANCE CURVES

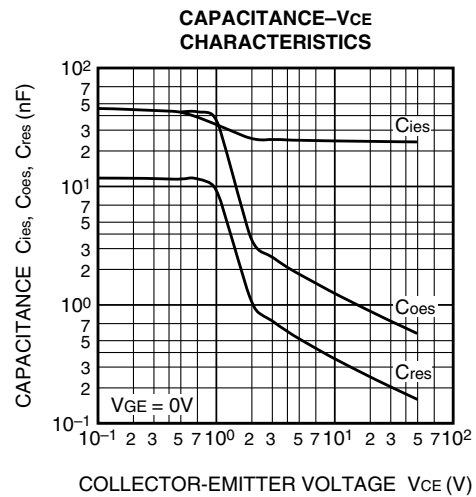
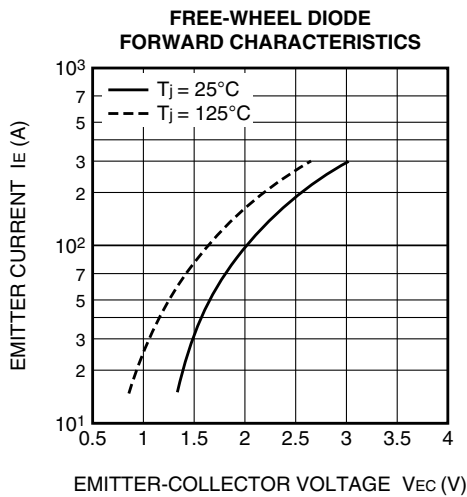
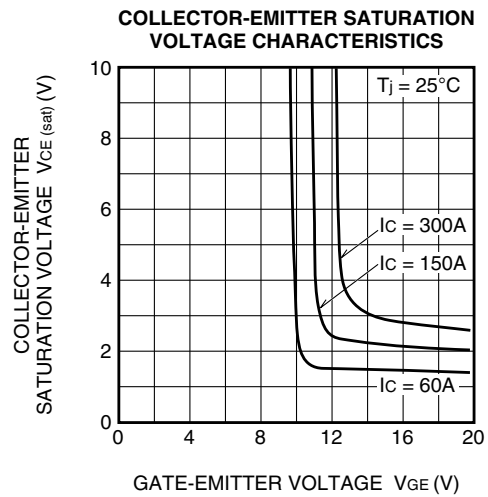
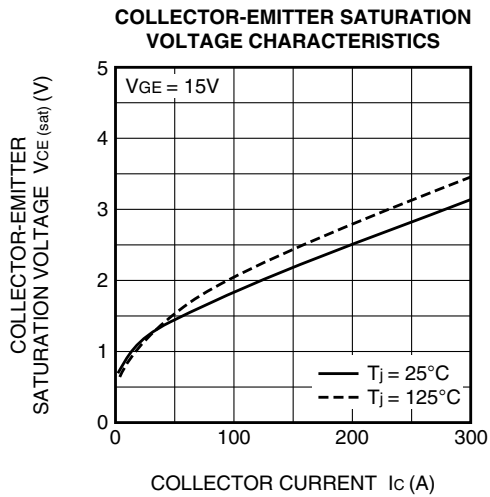
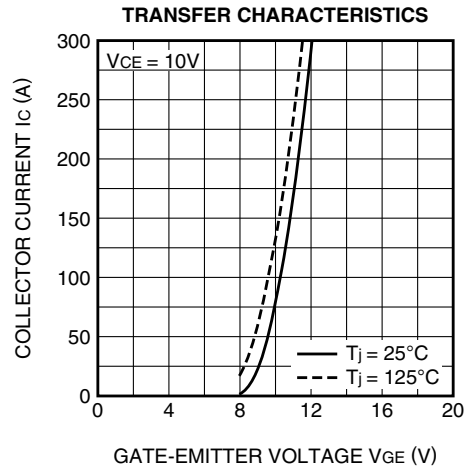
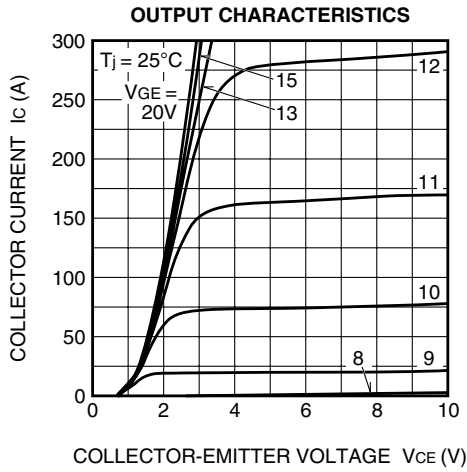

# CM150DY-34A

HIGH POWER SWITCHING USE

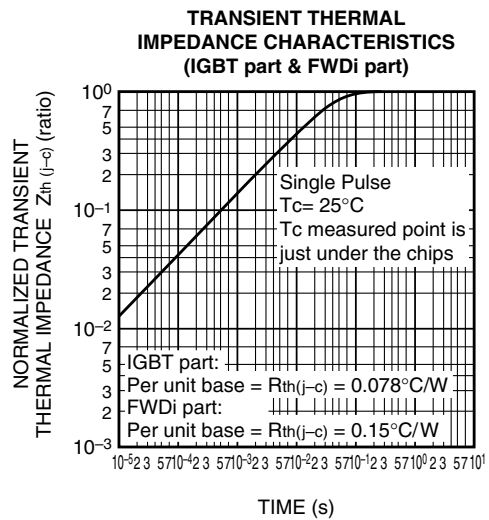
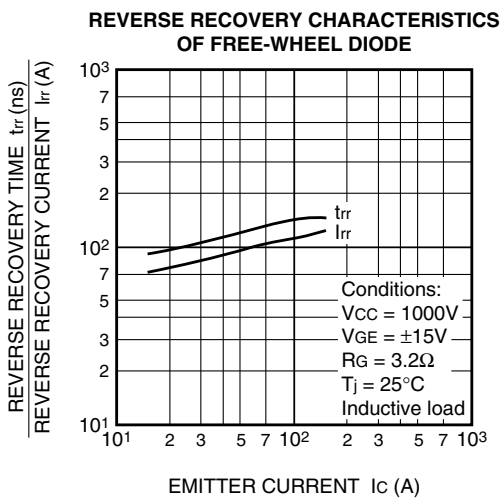
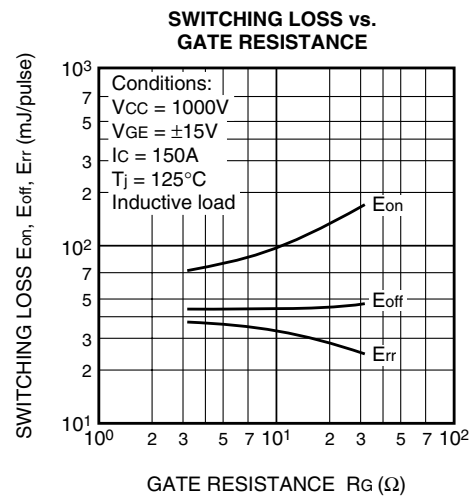
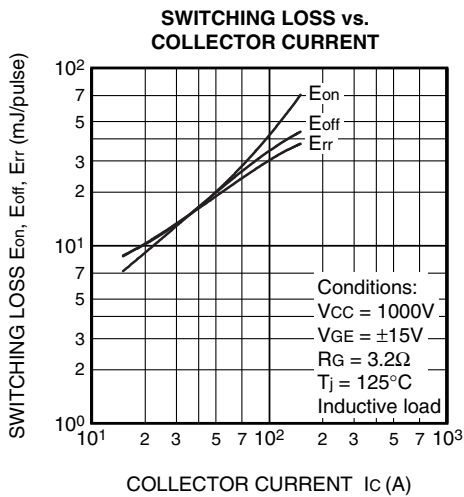
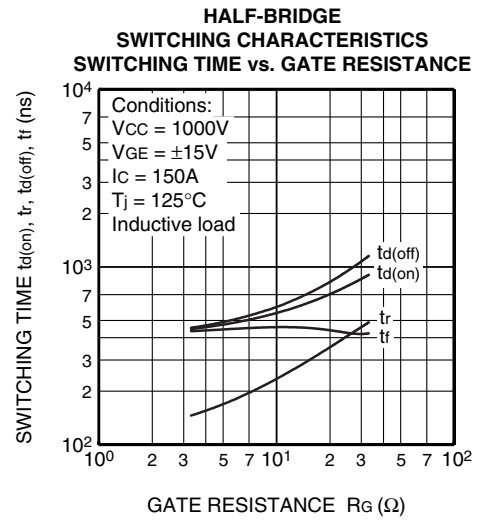
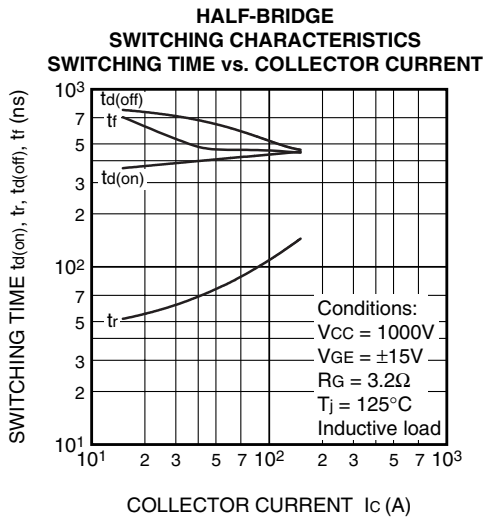

# CM150DY-34A

HIGH POWER SWITCHING USE

---

