

Sensori di prossimità induttivi M8 serie AE

M8 proximity inductive sensors AE series



Caratteristiche principali Main features

- > Dimensioni estremamente ridotte
> *Extremely reduced measure*
- > Corpo metallico
> *Metal housing*
- > Indicatore LED visibile 360°
> *LED status indicator 360° visible*
- > Contenitore con protezione IP 67
> *IP 67 housing protection*
- > Totalmente protetti contro danneggiamenti di tipo elettrico
> *Complete protection against electrical damages*
- > Modelli distanza standard e lunga distanza
> *Standard and long distance models*
- > Modelli con corpo standard e corpo corto
> *Standard and short body housing*
- > Marchio **CE**
> **CE Mark**

Disponibili, su richiesta, modelli ATEX, cat. 3
ATEX models, cat. 3, available on request

Descrizione del codice - Code structure

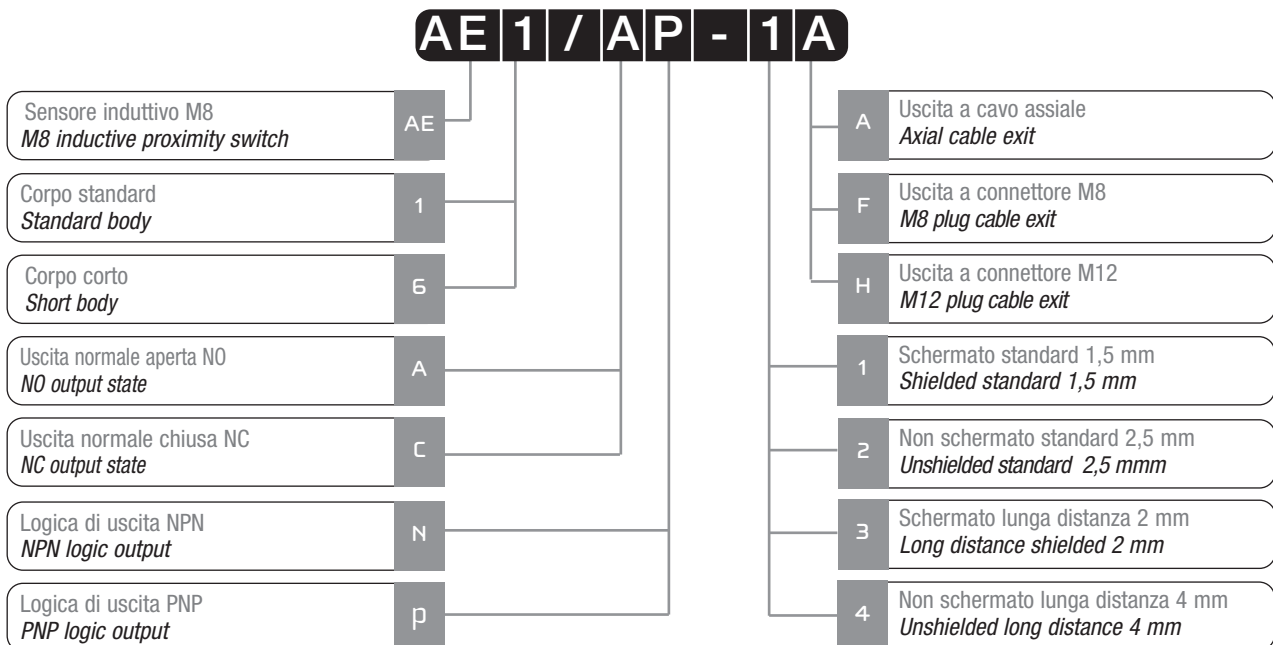

Modelli disponibili - Available models

Corpo Standard / Standard housing

Diametro Diameter	Montaggio Installation	Portata Distance	Conn. Plug	Distanza Distance	NPN/NO	PNP/NO	NPN/NC	PNP/NC
M8	Schermato Shielded	Standard	Cavo / Cable	1,5 mm	AE1/AN-1A	AE1/AP-1A	AE1/CN-1A	AE1/CP-1A
			M8	1,5 mm	AE1/AN-1F	AE1/AP-1F	AE1/CN-1F	AE1/CP-1F
			M12	1,5 mm	AE1/AN-1H	AE1/AP-1H	AE1/CN-1H	AE1/CP-1H
	Non schermato Unshielded	Standard	Cavo / Cable	2,5 mm	AE1/AN-2A	AE1/AP-2A	AE1/CN-2A	AE1/CP-2A
			M8	2,5 mm	AE1/AN-2F	AE1/AP-2F	AE1/CN-2F	AE1/CP-2F
			M12	2,5 mm	AE1/AN-2H	AE1/AP-2H	AE1/CN-2H	AE1/CP-2H
	Schermato Shielded	Lunga distanza Long distance	Cavo / Cable	2 mm	AE1/AN-3A	AE1/AP-3A	AE1/CN-3A	AE1/CP-3A
			M8	2 mm	AE1/AN-3F	AE1/AP-3F	AE1/CN-3F	AE1/CP-3F
			M12	2 mm	AE1/AN-3H	AE1/AP-3H	AE1/CN-3H	AE1/CP-3H
	Non schermato Unshielded	Lunga distanza Long distance	Cavo / Cable	4 mm	AE1/AN-4A	AE1/AP-4A	AE1/CN-4A	AE1/CP-4A
			M8	4 mm	AE1/AN-4F	AE1/AP-4F	AE1/CN-4F	AE1/CP-4F
			M12	4 mm	AE1/AN-4H	AE1/AP-4H	AE1/CN-4H	AE1/CP-4H

Corpo corto / Short housing

Diametro Diameter	Montaggio Installation	Portata Distance	Conn. Plug	Distanza Distance	NPN/NO	PNP/NO	NPN/NC	PNP/NC
M8	Schermato Shielded	Standard	Cavo / Cable	1,5 mm	AE6/AN-1A	AE6/AP-1A	AE6/CN-1A	AE6/CP-1A
			M8	1,5 mm	AE6/AN-1F	AE6/AP-1F	AE6/CN-1F	AE6/CP-1F
			M12	1,5 mm	AE6/AN-1H	AE6/AP-1H	AE6/CN-1H	AE6/CP-1H
	Non schermato Unshielded	Standard	Cavo / Cable	2,5 mm	AE6/AN-2A	AE6/AP-2A	AE6/CN-2A	AE6/CP-2A
			M8	2,5 mm	AE6/AN-2F	AE6/AP-2F	AE6/CN-2F	AE6/CP-2F
			M12	2,5 mm	AE6/AN-2H	AE6/AP-2H	AE6/CN-2H	AE6/CP-2H
	Schermato Shielded	Lunga distanza Long distance	Cavo / Cable	2 mm	AE6/AN-3A	AE6/AP-3A	AE6/CN-3A	AE6/CP-3A
			M8	2 mm	AE6/AN-3F	AE6/AP-3F	AE6/CN-3F	AE6/CP-3F
			M12	2 mm	AE6/AN-3H	AE6/AP-3H	AE6/CN-3H	AE6/CP-3H
	Non scherm. Unshielded	Lunga distanza Long distance	Cavo / Cable	4 mm	AE6/AN-4A	AE6/AP-4A	AE6/CN-4A	AE6/CP-4A
			M8	4 mm	AE6/AN-4F	AE6/AP-4F	AE6/CN-4F	AE6/CP-4F
			M12	4 mm	AE6/AN-4H	AE6/AP-4H	AE6/CN-4H	AE6/CP-4H

AE SERIES - INDUCTIVE SENSORS

Specifiche (In accordo con IEC EN 60947-5-2 / DIN 44030) - Specifications (According to IEC EN 60947-5-2 / DIN 44030)

Modelli / Models	AE*/**-1*	AE*/**-2*	AE*/**-3*	AE*/**-4*
Distanza nominale S_n / Nominal sensing distance S_n	5%			
Distanza di lavoro / Operating distance	1,5 mm	2,5 mm	2 mm	4 mm
Corsa differenziale / Hysteresis	1 ÷ 20%			
Dimensione azionatore normalizzato / Standard target	8x8 mm FE360			12x12 mm FE360
Ripetitività / Repeat accuracy U_0 20-30 V $T_a = 23^\circ\text{C} \pm 5^\circ\text{C}$	5%			
Campo di tensione di alimentazione / Supply voltage range	10 ÷ 30 Vcc / Vdc			
Massima ondulazione residua / Max ripple content	≤ 10 %			
Corrente di uscita / Output current	≤ 200 mA			
Tensione di saturazione di uscita / Output voltage drop	≤ 1,8 V @ 200 mA			
Corrente di alimentazione senza carico / No load supply current	10 mA			
Corrente di perdita / Leakage current	≤ 10 μA			
Frequenza di commutazione / Switching frequency	5 kHz			
Ritardo all'accensione / Time delay before availability	50 ms			
Campo di temperature ambiente / Ambient temperature range	-25 ÷ +70 °C			
Deriva termica di S_r / Temperature drift of S_r	10%			
Protezione al corto circuito / Short-circuit protection	Sì auto ripristinante / Yes auto reset			
Protezione all'inversione di polarità di alimentazione / Voltage reversal protection	Sì / Yes			
Protezione ai carichi induttivi / Induction protection	Sì / Yes			
Colpi e vibrazioni / Shocks and vibrations	IEC/EN60947-5-2 / §7.4			
Peso / Weight	16 g versione a connettore M8 / plug M8 version 20 g versione a connettore M12 / plug M12 version 43 g versione a cavo / cable version			
Indicatori LED / LED indicators	LED giallo stato dell'uscita / Yellow LED output state			
Grado di protezione / Degree of protection	IP 67 (EN60529)			
Protezione EMC / EMC protection:	Secondo / According to IEC/EN60947-5-2			
	IEC 60255-5	1 kV		
	IEC 61000-4-2	Livello 3 / Level 3 aria / air 8 kV		
	IEC 61000-4-3	Livello 3 / Level 3 10 V/m		
	IEC 61000-4-4	Livello 3 / Level 3 2 kV		
Materiale del corpo / Housing material	Ottone nichelato / Nickel-plated brass			
Superficie sensibile / Sensing face	PBT			
Connessione / Connection	Cavo / Cable 2 m PVC Connettore / Plug M8 o/or M12			

Coefficienti di riduzione - Correction factors

Codice / Code	Acciaio / Steel FE 360	Rame Copper	Alluminio Aluminium	Ottone Brass	Acciaio INOX Stainless steel
AE*/**-1*	1	0,29	0,38	0,49	0,78
AE*/**-2*	1	0,43	0,51	0,59	0,83
AE*/**-3*	1	0,35	0,43	0,52	0,78
AE*/**-4*	1	0,47	0,52	0,58	0,79

Schemi elettrici delle connessioni - Electrical diagrams of the connections

Schema di collegamento PNP
Wiring diagram PNP

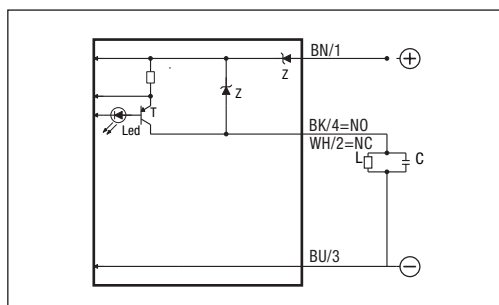

Schema di collegamento NPN
Wiring diagram NPN

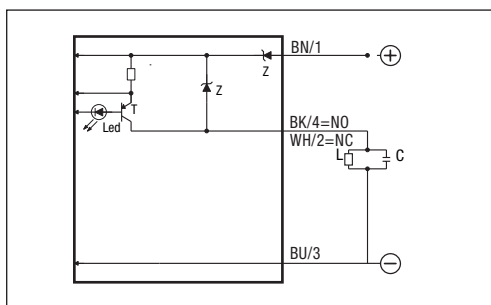

Legenda Key

- BN → marrone/brown
- BK → nero/black
- PK → rosa/pink
- BU → blu/blue
- WH → bianco/white
- GY → grigio/gray

Connettore - Plug

M8

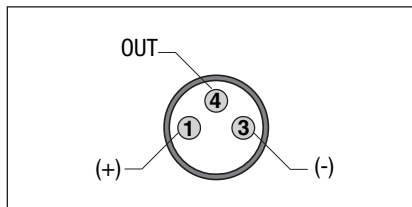

M12 - NO

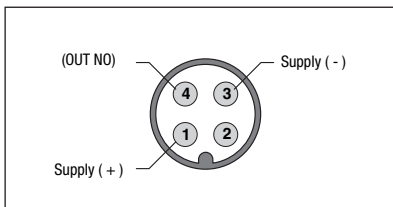

M12 - NC

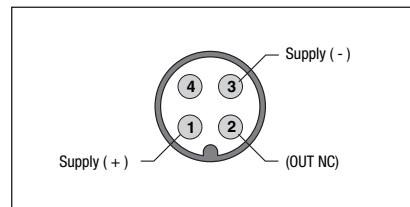

Connettori serie CD / Connectors CD series

Curva di risposta - Response diagram

AE*/**-1*

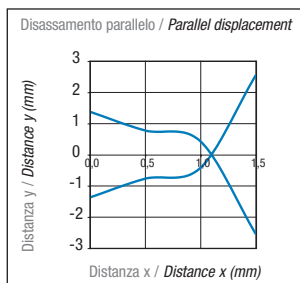

AE*/**-2*

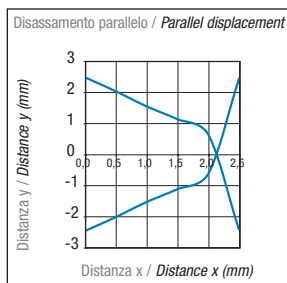

AE*/**-3*

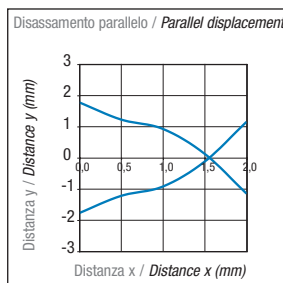

AE*/**-4*

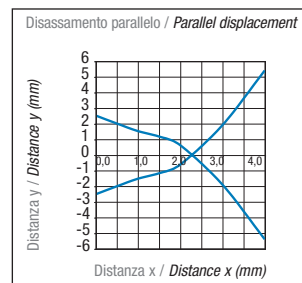

Montaggio - Installation

	D4	D1	D2	D3
AE*/**-1*	≥ 0 mm	≥ 3,25 mm	≥ 6,5 mm	≥ 4,5 mm
AE*/**-2*	≥ 4 mm ⁽¹⁾	≥ 6,5 mm	≥ 13 mm	≥ 7,5 mm
AE*/**-3*	≥ 0 mm	≥ 3,25 mm	≥ 6,5 mm	≥ 6 mm
AE*/**-4*	≥ 4 mm	≥ 6,5 mm	≥ 13 mm	≥ 12 mm

(1) ≥ 0 mm per materiali non magnetici / for non magnetic materials.