

IRF7324D1

FETKY™ MOSFET / Schottky Diode

- Co-packaged HEXFET® Power MOSFET and Schottky Diode
- Ideal for Mobile Phone Applications
- Generation V Technology
- SO-8 Footprint

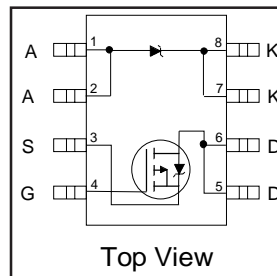

$V_{DSS} = -20V$
$R_{DS(on)} = 0.27\Omega$
Schottky $V_f = 0.39V$

Description

The FETKY™ family of co-packaged HEXFETs and Schottky diodes offer the designer an innovative board space saving solution for switching regulator applications. Generation 5 HEXFETs utilize advanced processing techniques to achieve extremely low on-resistance per silicon area. Combining this technology with International Rectifier's low forward drop Schottky rectifiers results in an extremely efficient device suitable for use in a wide variety of portable electronics applications.

The SO-8 has been modified through a customized leadframe for enhanced thermal characteristics. The SO-8 package is designed for vapor phase, infrared or wave soldering techniques.

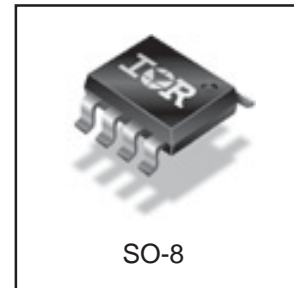

Absolute Maximum Ratings

	Parameter	Max.	Units
V_{DS}	Drain-to-Source Voltage	-20	V
V_{GS}	Gate-to-Source Voltage	± 12	
$I_D @ T_A = 25^\circ C$	Continuous Drain Current, $V_{GS} @ 10V$	-2.2	A
$I_D @ T_A = 70^\circ C$	Continuous Drain Current, $V_{GS} @ 10V$	-1.8	
I_{DM}	Pulsed Drain Current ①	-22	
$P_D @ T_A = 25^\circ C$	Power Dissipation ④	2.0	W
$P_D @ T_A = 70^\circ C$	Power Dissipation ④	1.3	
dV/dt	Peak Diode Recovery ②	-0.74	V/ns
	Linear Derating Factor	16	mW/°C
T_J	Operating Junction and	-55 to + 150	°C
T_{STG}	Storage Temperature Range		

Thermal Resistance

	Parameter	Typ.	Max.	Units
$R_{\theta JL}$	Junction-to-Drain Lead ⑤	—	20	°C/W
$R_{\theta JA}$	Junction-to-Ambient ④⑤	—	62.5	

Notes ① through ⑤ are on page 8
www.irf.com

IRF7324D1

International
 Rectifier

MOSFET Electrical Characteristics @ $T_J = 25^\circ\text{C}$ (unless otherwise specified)

	Parameter	Min.	Typ.	Max.	Units	Conditions
BV_{DSS}	Drain-to-Source Breakdown Voltage	-20	—	—	V	$V_{GS} = 0V, I_D = -250\mu A$
$R_{DS(on)}$	Static Drain-to-Source On-Resistance	—	0.155	0.270	Ω	$V_{GS} = -4.5V, I_D = -1.2A$ ③
		—	0.260	0.400		$V_{GS} = -2.7V, I_D = -0.6A$ ③
$V_{GS(th)}$	Gate Threshold Voltage	-0.70	—	—	V	$V_{DS} = V_{GS}, I_D = -250\mu A$
I_{DSS}	Drain-to-Source Leakage Current	—	—	-1.0	μA	$V_{DS} = -16V, V_{GS} = 0V$
		—	—	-25		$V_{DS} = -16V, V_{GS} = 0V, T_J = 125^\circ\text{C}$
I_{GSS}	Gate-to-Source Forward Leakage	—	—	100	nA	$V_{DS} = -12V$
	Gate-to-Source Reverse Leakage	—	—	-100		$V_{GS} = 12V$
g_{fs}	Forward Transconductance	2.4	—	—	S	$V_{DS} = -16V, I_D = -2.2A$
Q_g	Total Gate Charge	—	5.2	7.8	nC	$I_D = -2.2A$
Q_{gs}	Gate-to-Source Charge	—	0.88	—		$V_{GS} = -4.5V$
Q_{gd}	Gate-to-Drain Charge	—	2.5	—		$V_{DD} = -16V$
$t_{d(on)}$	Turn-On Delay Time	—	10	—	ns	$V_{DD} = -10V, V_{GS} = -4.5V$ ③
t_r	Rise Time	—	12	—		$I_D = -2.2A$
$t_{d(off)}$	Turn-Off Delay Time	—	11	—		$R_G = 6.0\Omega$
t_f	Fall Time	—	7.6	—		$R_D = 4.5\Omega$
C_{iss}	Input Capacitance	—	260	—	pF	$V_{GS} = 0V$
C_{oss}	Output Capacitance	—	140	—		$V_{DS} = -15V$
C_{rss}	Reverse Transfer Capacitance	—	70	—		$f = 1.0\text{MHz}$

MOSFET Source-Drain Ratings and Characteristics

	Parameter	Min.	Typ.	Max.	Units	Conditions
I_S	Continuous Source Current	—	—	-2.2		
I_{SM}	Pulsed Source Current	—	—	-22		
V_{SD}	Diode Forward Voltage	—	—	-1.2	V	$T_J = 25^\circ\text{C}, I_S = -2.2A, V_{GS} = 0V$ ③
t_{rr}	Reverse Recovery Time	—	26	39	ns	$T_J = 25^\circ\text{C}, I_F = -2.2A, V_{DD} = -10V$
Q_{rr}	Reverse Recovery Charge	—	24	36	nC	$di/dt = 100A/\mu s$ ③

Schottky Diode Maximum Ratings

	Parameter	Max.	Units	Conditions	
$I_{F(av)}$	Max. Average Forward current	1.7	A	50% Duty Cycle Rectangular Wave, $T_A = 25^\circ\text{C}$	
		1.2		$T_A = 70^\circ\text{C}$	
I_{SM}	Max. Peak one cycle Non-repetitive Surge Current	120		5 μs sine or 3 μs Rect. Pulse	Following any rated load condition & with VRRM applied
		11		10ms sine or 6ms Rect. Pulse	

Schottky Diode Electrical Specifications

	Parameter	Max.	Units	Conditions	
V_{FM}	Max. Forward Voltage Drop	0.50	V	$I_F = 1.0A, T_J = 25^\circ\text{C}$	
		0.62		$I_F = 2.0A, T_J = 25^\circ\text{C}$	
		0.39		$I_F = 1.0A, T_J = 125^\circ\text{C}$	
		0.57		$I_F = 2.0A, T_J = 125^\circ\text{C}$	
I_{RM}	Max. Reverse Leakage Current	0.05	mA	$V_R = 20V$	$T_J = 25^\circ\text{C}$
		10			$T_J = 125^\circ\text{C}$
C_t	Max. Junction Capacitance	92	pF	$V_R = 5V_{dc}$ (100kHz to 1MHz) 25°C	
dV/dt	Max. Voltage Rate of Charge	3600	V/ μs	Rated V_R	

Power Mosfet Characteristics

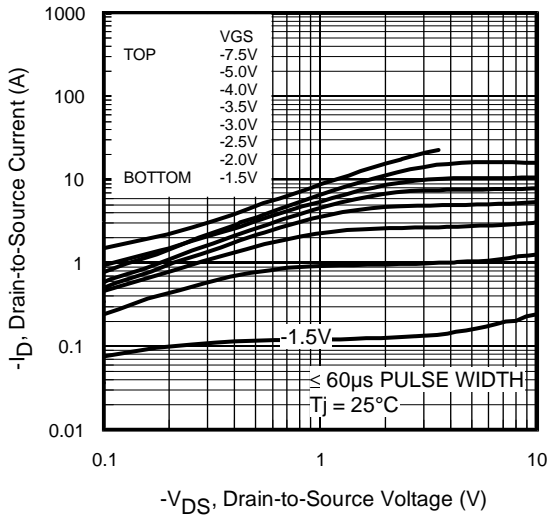

Fig 1. Typical Output Characteristics

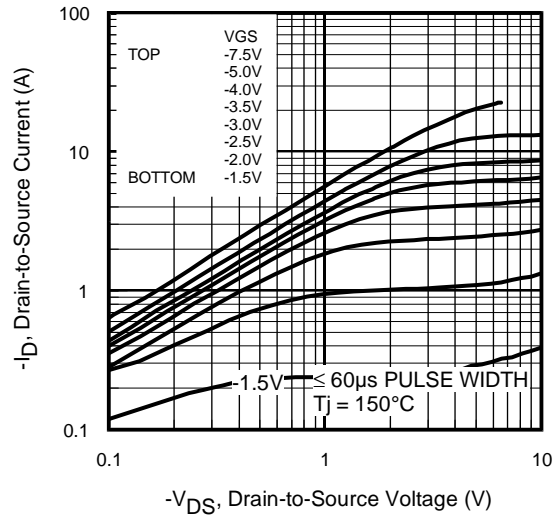

Fig 2. Typical Output Characteristics

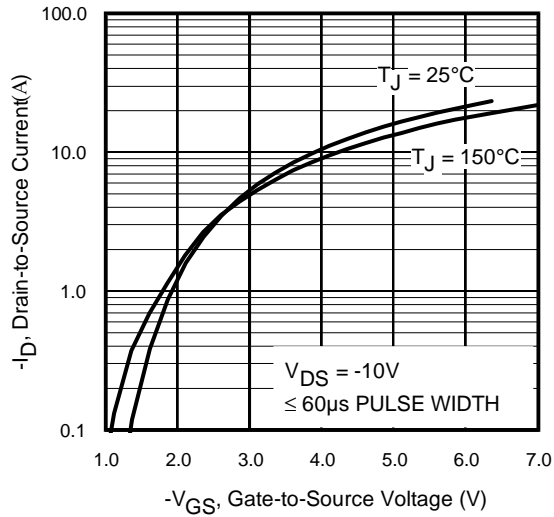

Fig 3. Typical Transfer Characteristics

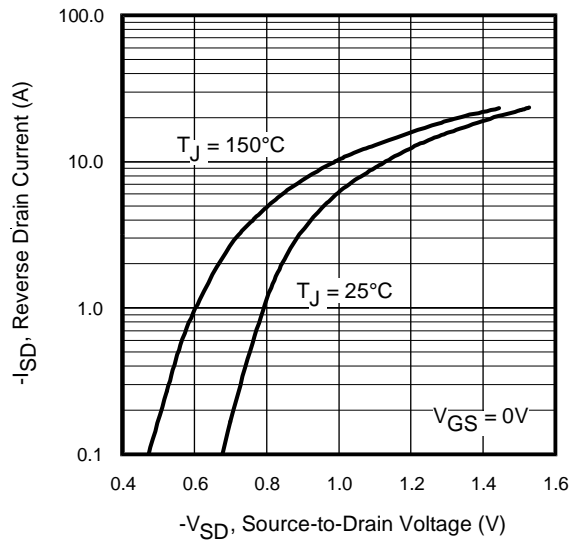

Fig 4. Typical Source-Drain Diode Forward Voltage

Power Mosfet Characteristics

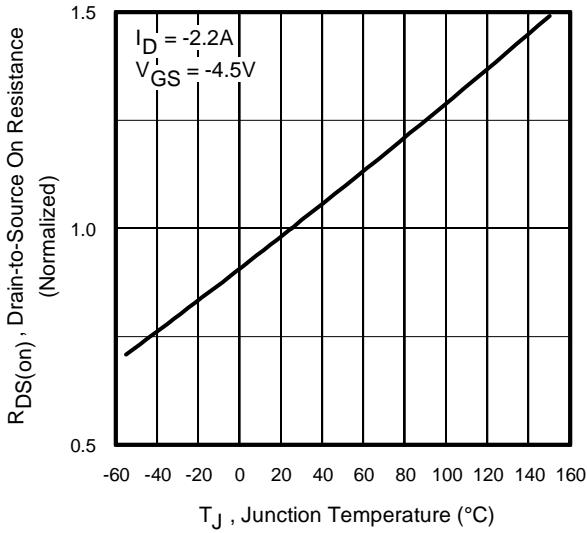

Fig 5. Normalized On-Resistance Vs. Temperature

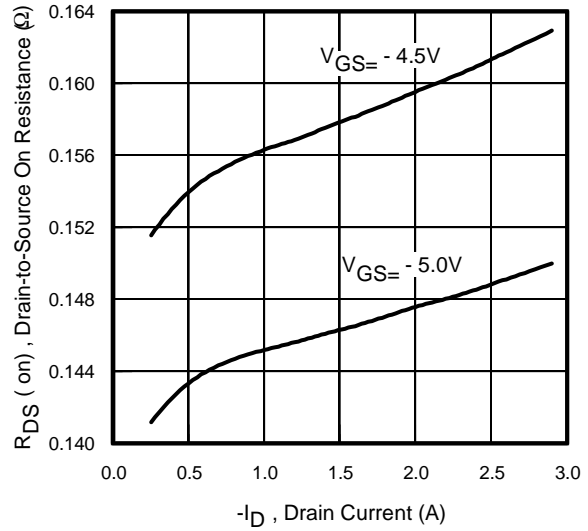

Fig 6. Typical On-Resistance Vs. Drain Current

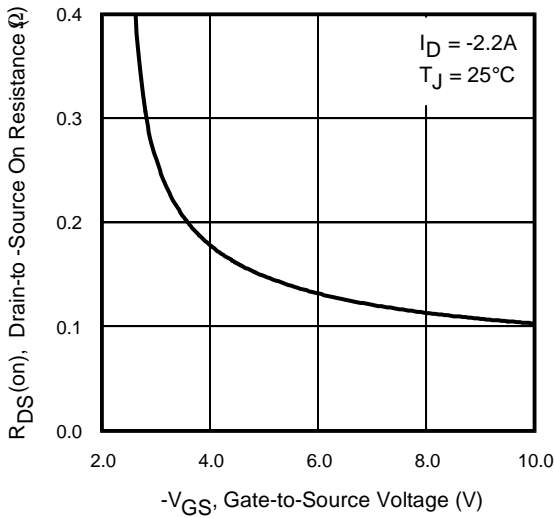

Fig 7. Typical On-Resistance Vs. Gate Voltage

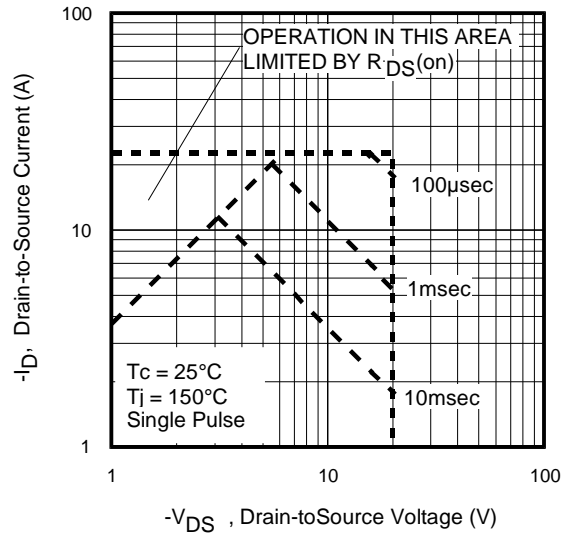

Fig 8. Maximum Safe Operating Area

Power Mosfet Characteristics

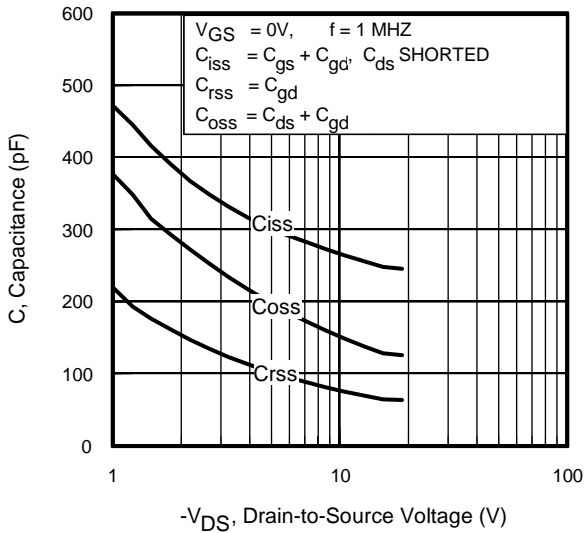

Fig 9. Typical Capacitance Vs. Drain-to-Source Voltage

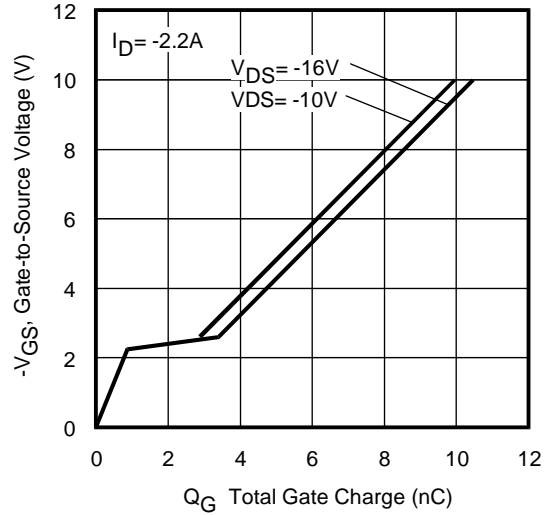

Fig 10. Typical Gate Charge Vs. Gate-to-Source Voltage

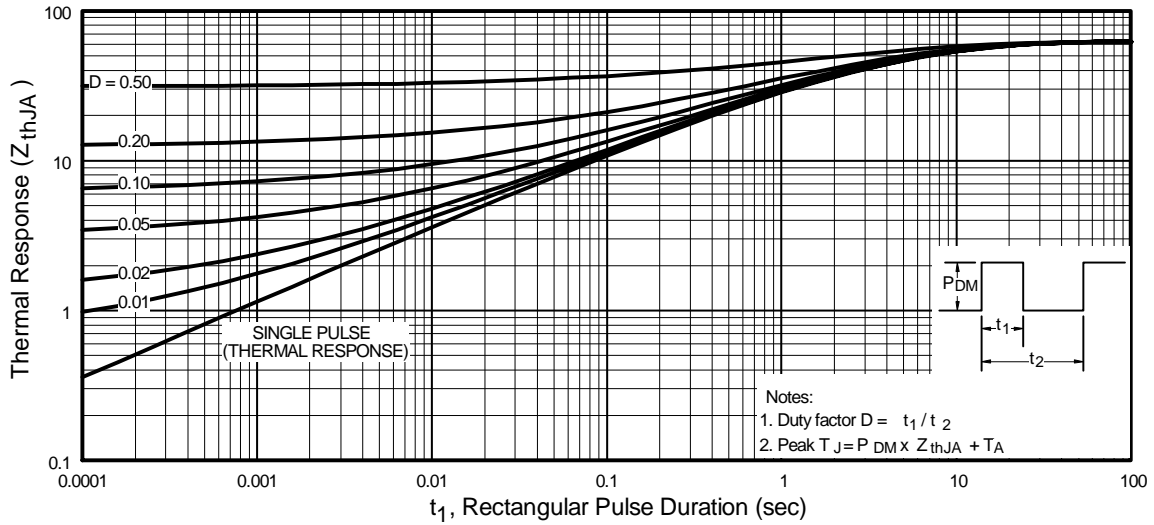

Fig 11. Maximum Effective Transient Thermal Impedance, Junction-to-Ambient

Schottky Diode Characteristics

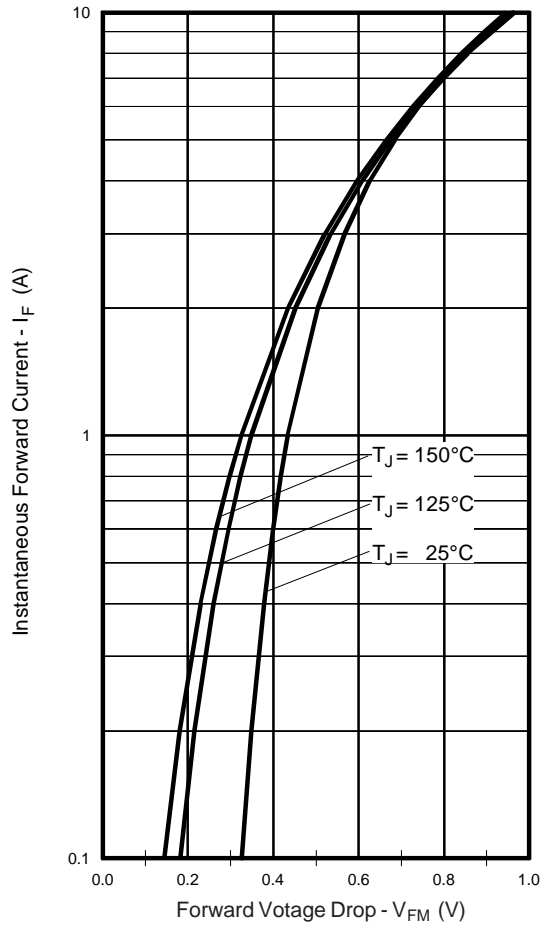

Fig. 12 -Typical Forward Voltage Drop Characteristics

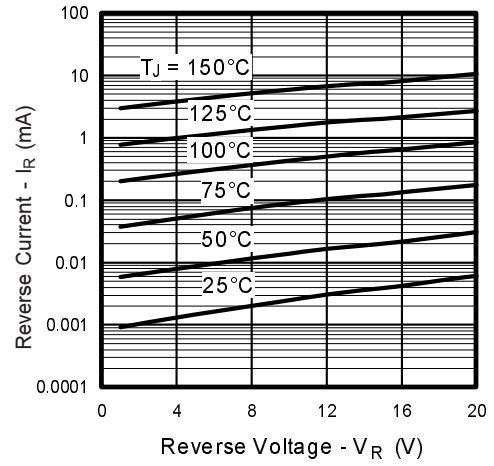

Fig. 13 - Typical Values of Reverse Current Vs. Reverse Voltage

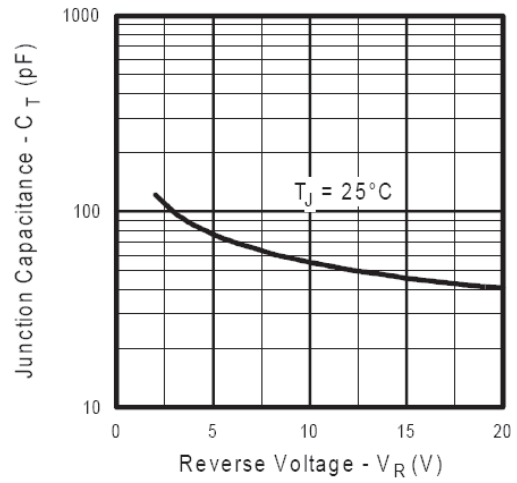
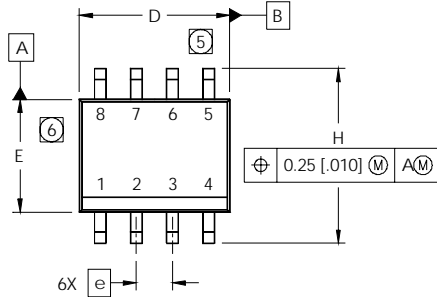

Fig.14 - Typical Junction capacitance Vs.Reverse Voltage

SO-8 (Fetky) Package Outline

Dimensions are shown in millimeters (inches)



DIM	INCHES		MILLIMETERS	
	MIN	MAX	MIN	MAX
A	.0532	.0688	1.35	1.75
A1	.0040	.0098	0.10	0.25
b	.013	.020	0.33	0.51
c	.0075	.0098	0.19	0.25
D	.189	.1968	4.80	5.00
E	.1497	.1574	3.80	4.00
e	.050	BASIC	1.27	BASIC
e1	.025	BASIC	0.635	BASIC
H	.2284	.2440	5.80	6.20
K	.0099	.0196	0.25	0.50
L	.016	.050	0.40	1.27
y	0°	8°	0°	8°

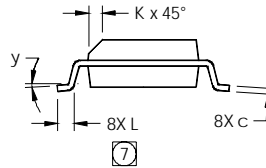
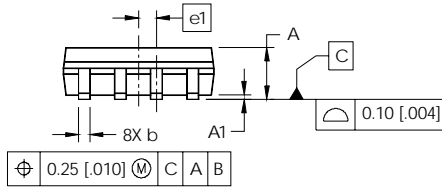

NOTES:

1. DIMENSIONING & TOLERANCING PER ASME Y14.5M-1994.
2. CONTROLLING DIMENSION: MILLIMETER
3. DIMENSIONS ARE SHOWN IN MILLIMETERS [INCHES].
4. OUTLINE CONFORMS TO JEDEC OUTLINE MS-012AA
- ⑤ DIMENSION DOES NOT INCLUDE MOLD PROTRUSIONS. MOLD PROTRUSIONS NOT TO EXCEED 0.15 [0.006].
- ⑥ DIMENSION DOES NOT INCLUDE MOLD PROTRUSIONS. MOLD PROTRUSIONS NOT TO EXCEED 0.25 [0.010].
- ⑦ DIMENSION IS THE LENGTH OF LEAD FOR SOLDERING TO A SUBSTRATE.

FOOTPRINT

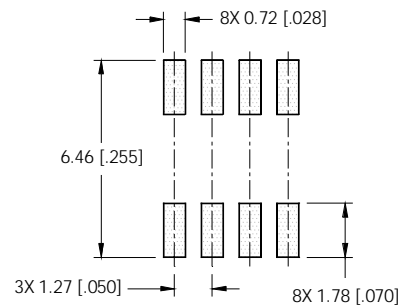

SO-8 (Fetky) Part Marking Information

EXAMPLE: THIS IS AN IRF7807D1 (FETKY)

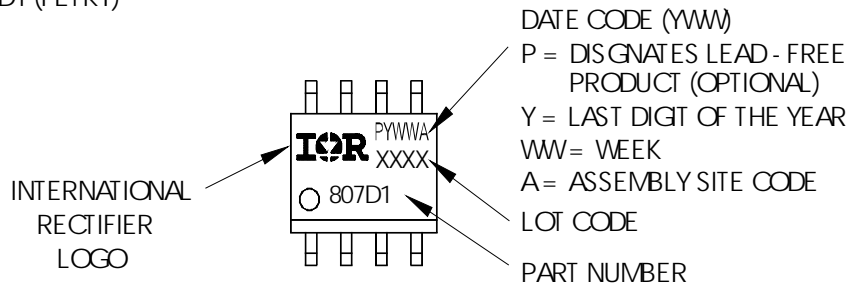

IRF7324D1

International
IOR Rectifier

SO-8 (Fetky) Tape and Reel

Dimensions are shown in millimeters (inches)

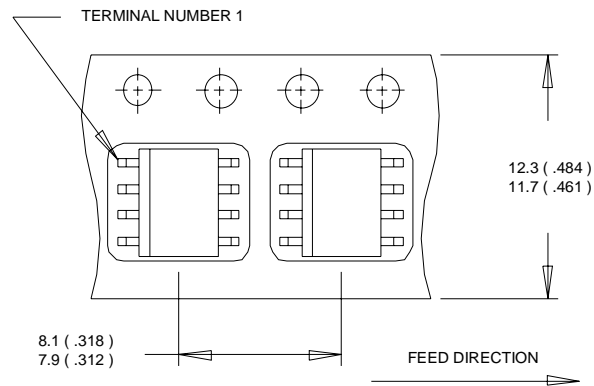

NOTES:

1. CONTROLLING DIMENSION : MILLIMETER.
2. ALL DIMENSIONS ARE SHOWN IN MILLIMETERS(INCHES).
3. OUTLINE CONFORMS TO EIA-481 & EIA-541.

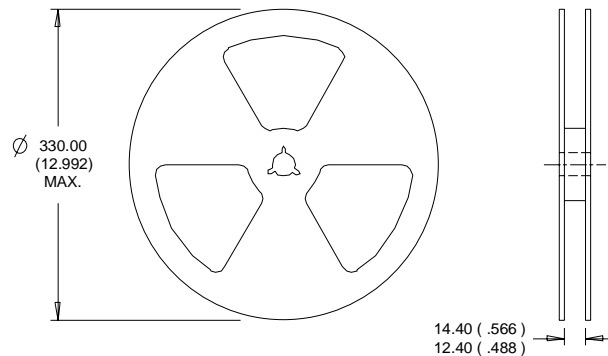

NOTES :

1. CONTROLLING DIMENSION : MILLIMETER.
2. OUTLINE CONFORMS TO EIA-481 & EIA-541.

Notes:

- ① Repetitive rating; pulse width limited by maximum junction temperature (see figure 11)
- ② $I_{SD} \leq -2.2A$, $di/dt \leq -96A/\mu s$, $V_{DD} \leq V_{(BR)DSS}$, $T_J \leq 150^\circ C$
- ③ Pulse width $\leq 300\mu s$; duty cycle $\leq 2\%$
- ④ Surface mounted on FR-4 board, steady-state
- ⑤ R_{θ} is measured at T_J of approximately $90^\circ C$.

International
IOR Rectifier

IR WORLD HEADQUARTERS: 233 Kansas St., El Segundo, California 90245, USA Tel: (310) 252-7105
TAC Fax: (310) 252-7903

Visit us at www.irf.com for sales contact information. 10/04

www.irf.com

Mouser Electronics

Authorized Distributor

Click to View Pricing, Inventory, Delivery & Lifecycle Information:

[International Rectifier:](#)

[IRF7324D1PBF](#) [IRF7324D1TRPBF](#)