

### ITR20002

#### Features

- Cut-off visible wavelength  $\lambda_p=840\text{nm}$
- Fast response time
- High sensitivity
- Pb free
- High analytic

#### Description

The **ITR20002** consist of an infrared emitting diode and an NPN silicon phototransistor, encased side-by-side on converging optical axis in a black thermoplastic housing. The phototransistor receives radiation from the IR only. This is the normal situation. But when an object is in between, phototransistor could not receive the radiation.

#### Applications

- Mouse Copier
- Floppy disk driver
- Non-contact Switching
- For Direct PC Board

**Device Selection Guide**

Device No.	Chip Material	LENS COLOR
IR	GaAlAs	Water Clear
PT	Silicon	Water Clear

**Absolute Maximum Ratings (Ta=25 °C)**

Parameter		Symbol	Ratings	Unit
Input	Power Dissipation at(or below) 25 °C Free Air Temperature	Pd	100	mW
	Reverse Voltage	V <sub>R</sub>	5	V
	Forward Current	I <sub>F</sub>	60	mA
	Peak Forward Current (*1) Pulse width 100 μs, Duty cycle=1%	I <sub>FP</sub>	1	A
Output	Collector Power Dissipation	P <sub>C</sub>	80	mW
	Collector Current	I <sub>C</sub>	20	mA
	Collector-Emitter Voltage	B V <sub>CEO</sub>	35	V
	Emitter-Collector Voltage	B V <sub>ECO</sub>	6	V
Operating Temperature		Topr	-25~+85	
Storage Temperature		Tstg	-40~+85	
Lead Soldering Temperature (*2) (1/16 inch form body for 5 seconds)		Tsol	260	

(\* 1)  $t_w=100 \mu \text{ sec.}$ ,  $T=10 \text{ msec.}$  (\* 2)  $t=5 \text{ Sec}$

Electro-Optical Characteristics (Ta=25 )

Parameter		Symbol	Min.	Typ.	Max.	Unit	Conditions
Input	Forward Voltage	$V_F$	---	1.2	1.5	V	$I_F=20\text{mA}$
	Reverse Current	$I_R$	---	---	10	$\mu\text{A}$	$V_R=5\text{V}$
	Peak Wavelength	$\lambda_p$	---	940	---	nm	$I_F=20\text{mA}$
	View Angle	2 $\theta$ 1/2	---	30	---	Deg	$I_F=20\text{mA}$
Output	Dark Current	$I_{CEO}$	---	---	100	nA	$V_{CE}=20\text{V}, E_e=0\text{mW/cm}^2$
	C-E Saturation Voltage	$V_{CE(sat)}$	---	---	0.4	V	$I_C=0.04\text{mA}$ $I_F=40\text{mA}$
Transfer Characteristics	Collect Current	$I_C(ON)$	0.04	---	0.9	mA	$V_{CE}=5\text{V } I_F=20\text{mA}$
	Rise time	$t_r$	---	20	---	$\mu\text{sec}$	$V_{CE}=2\text{V}$ $I_C=100\mu\text{A}$ $R_L=100\Omega$
	Fall time	$t_f$	---	25	---	$\mu\text{sec}$	

Typical Electrical/Optical/Characteristics Curves for IR

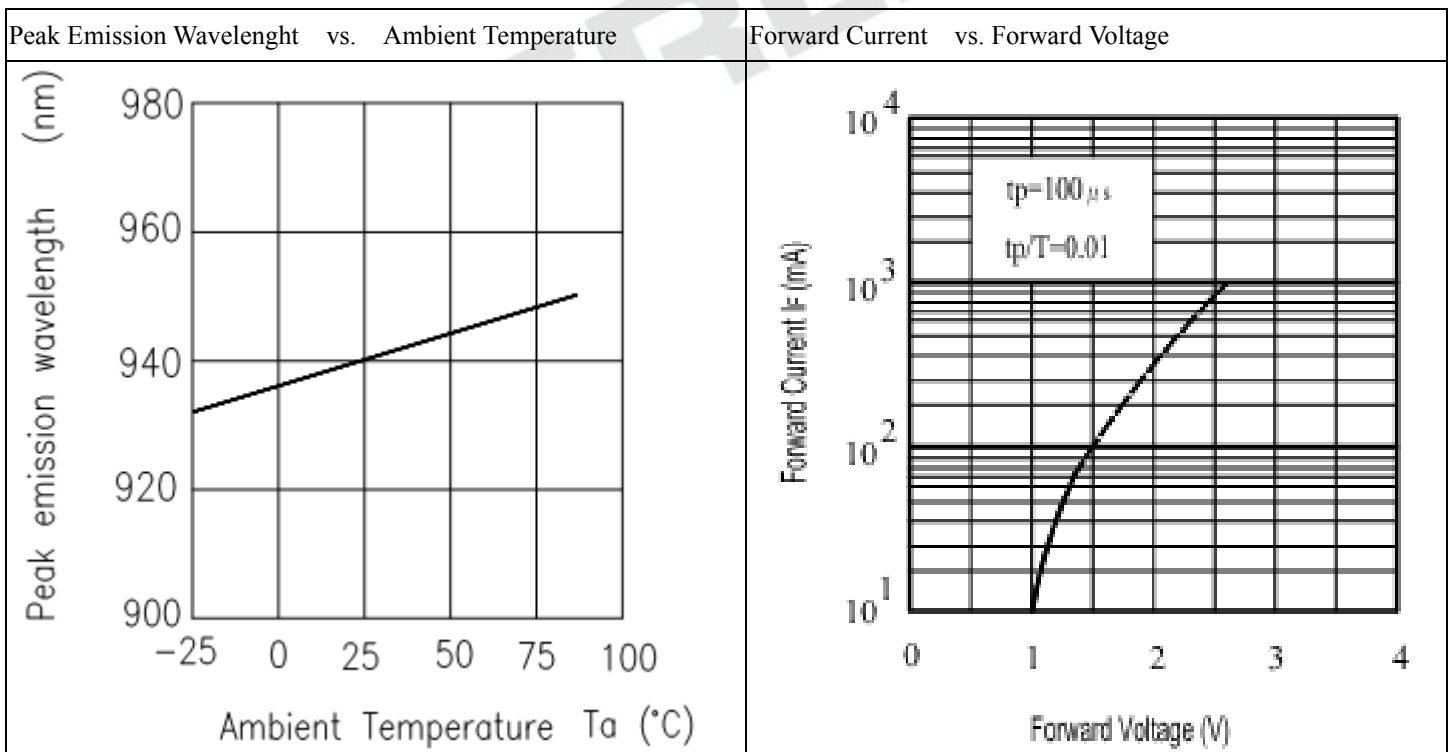
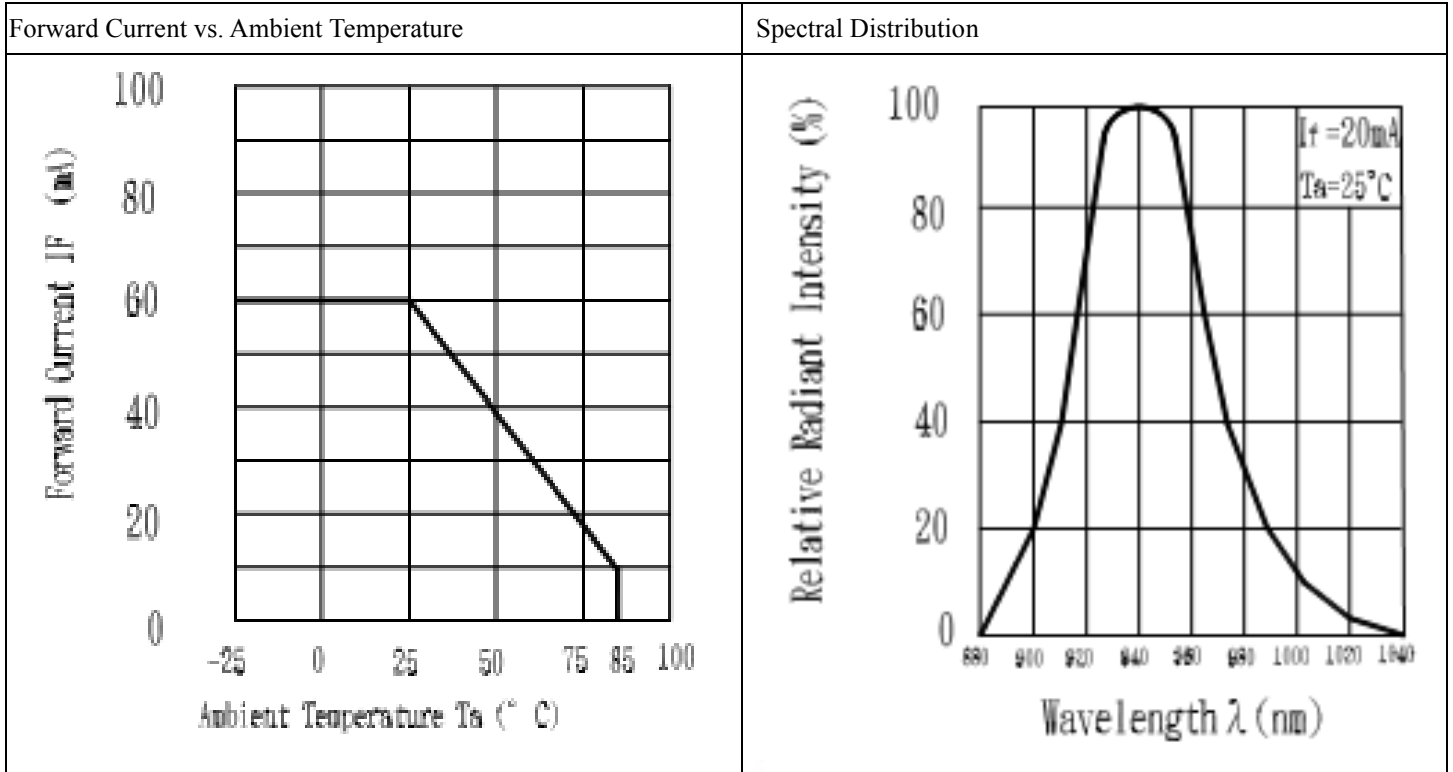

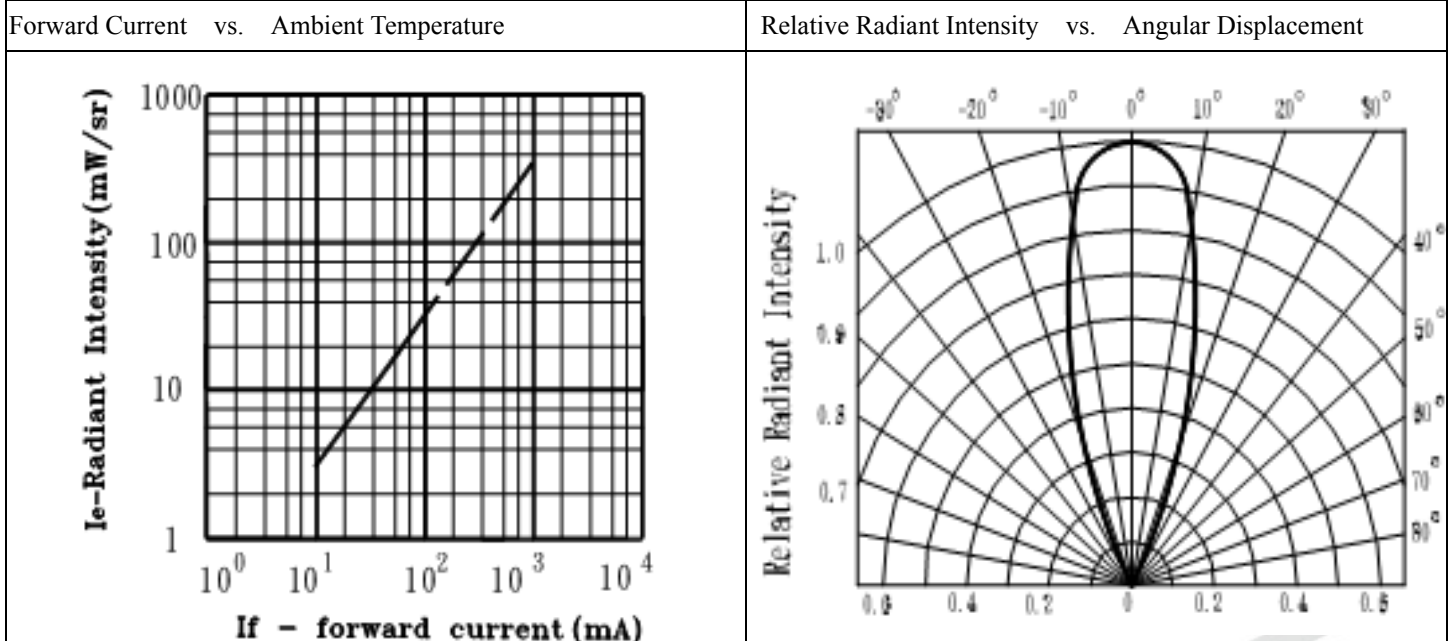

Typical Electro/Optical/Characteristics Curves for PT

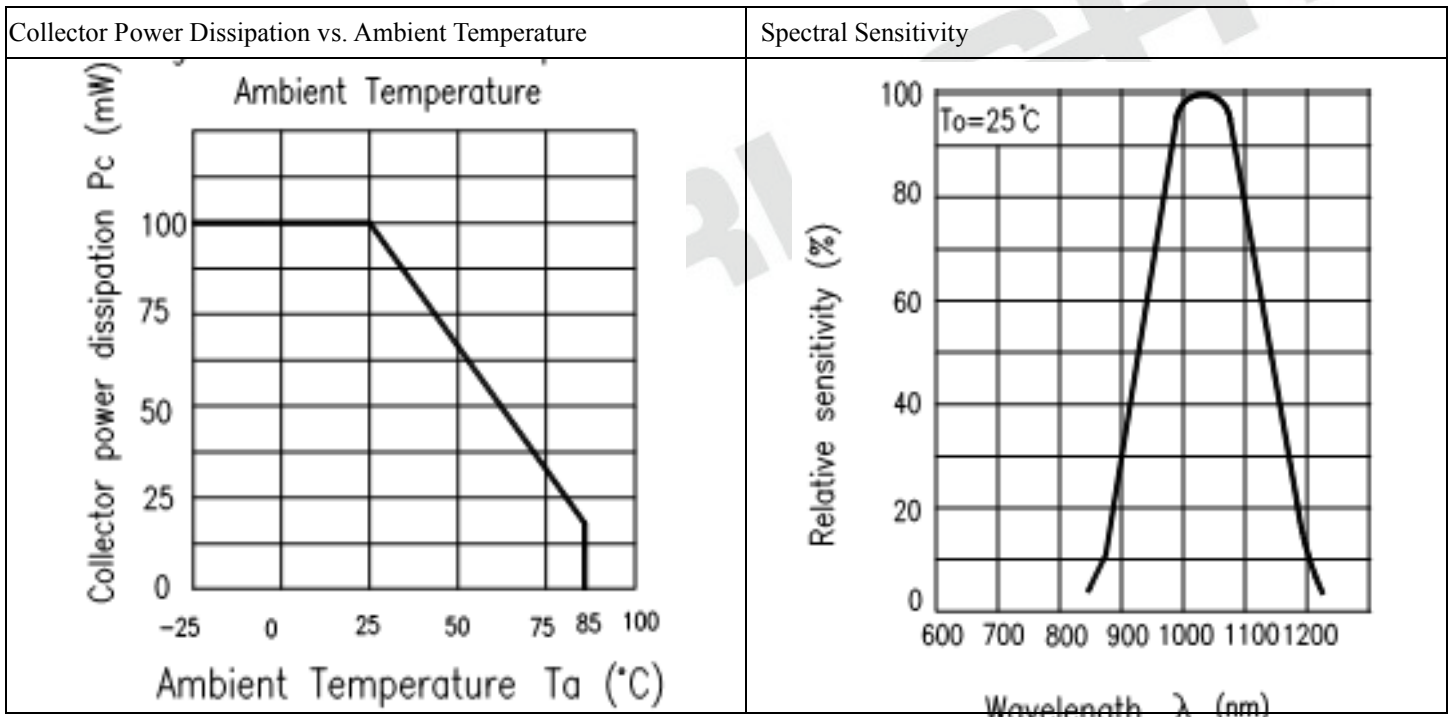

Relative Collector Current vs Ambient Temperature

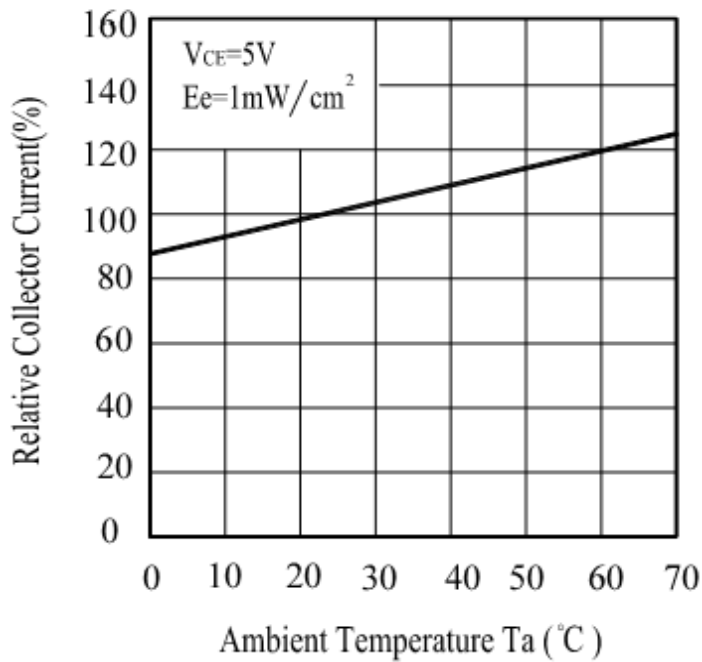

Collector Current vs. Irradiance

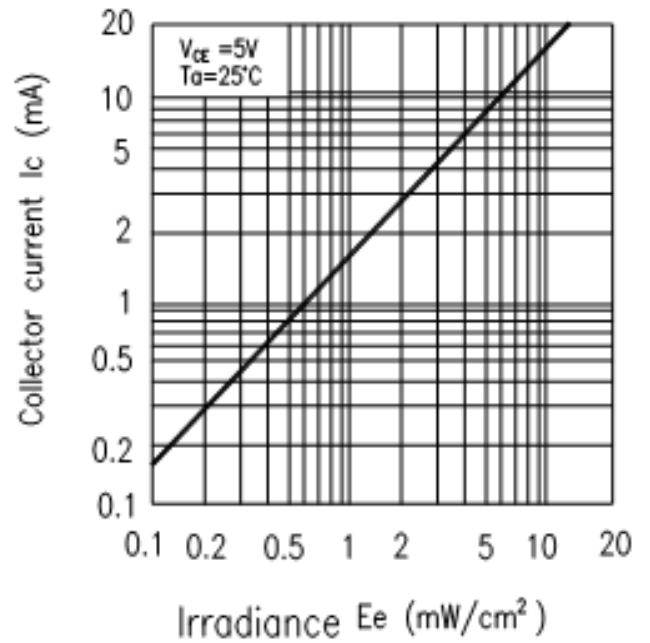

Collector Current vs. Ambient Temperature

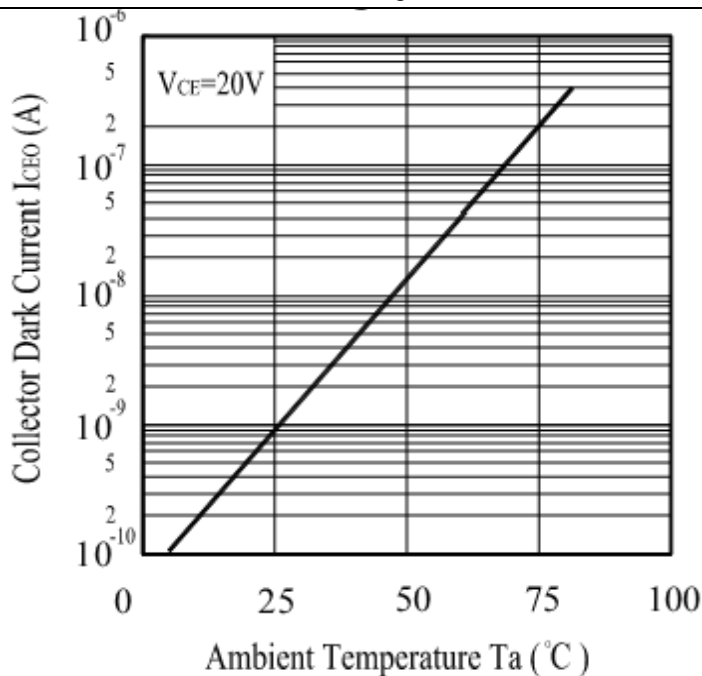

Collector Current vs. Collector-emitter Voltage

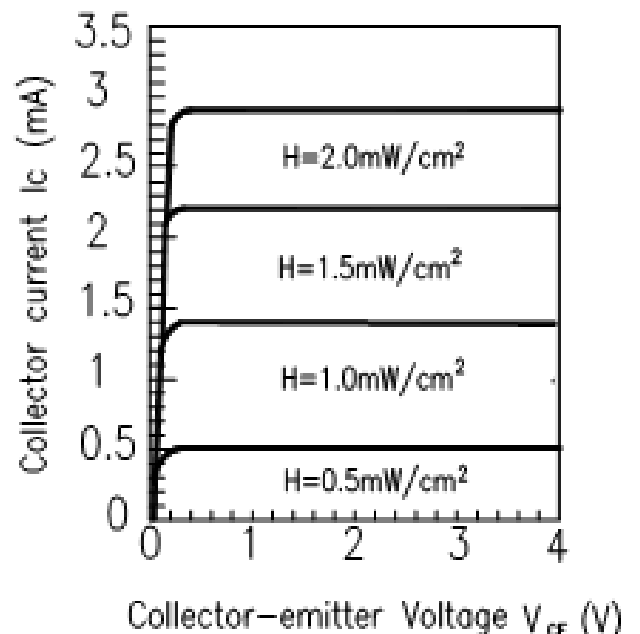

Package Dimension

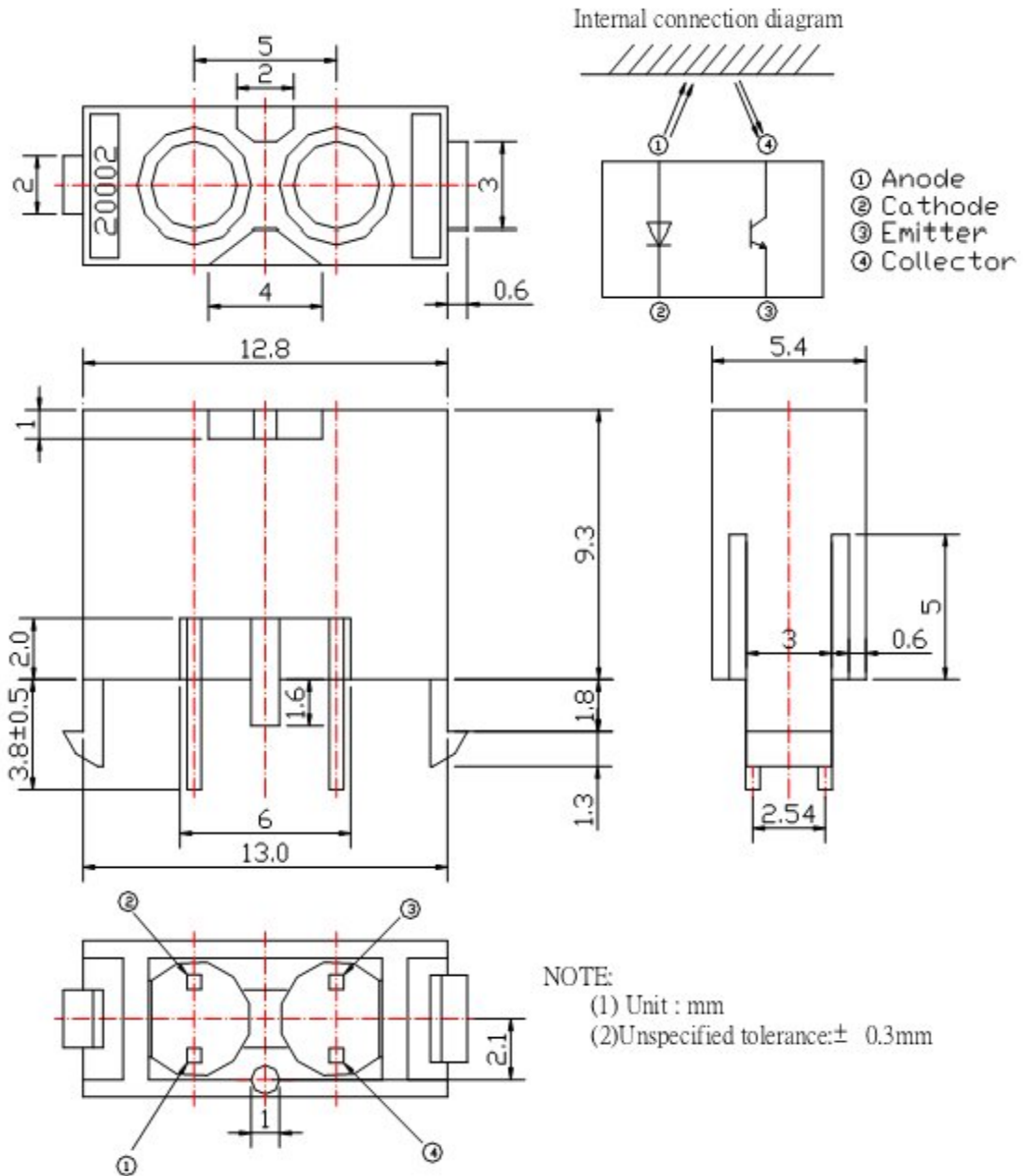

**Packing Quantity Specification**

1. 150pcs/1Bag, 5Bags/1Box
2. 10Boxes/1Carton

**Label Form Specification**



- CPN: Customer's Product Number
- P/N: Product Number
- QTY: Packing Quantity
- CAT: Luminous Intensity Rank
- HUE: Dom. Wavelength Rank
- REF: Forward Voltage Rank
- LOT No: Lot Number
- X: Month
- Reference: Identify Label Number

**Notes**

1. Above specification may be changed without notice. EVERLIGHT will reserve authority on material change for above specification.
2. When using this product, please observe the absolute maximum ratings and the instructions for using outlined in these specification sheets. EVERLIGHT assumes no responsibility for any damage resulting from use of the product which does not comply with the absolute maximum ratings and the instructions included in these specification sheets.
3. These specification sheets include materials protected under copyright of EVERLIGHT corporation. Please don't reproduce or cause anyone to reproduce them without EVERLIGHT's consent.



# Mouser Electronics

Authorized Distributor

Click to View Pricing, Inventory, Delivery & Lifecycle Information:

[Everlight:](#)

[ITR-20002](#) [ITR20002-A](#)