

# SELECTION GUIDE

Ver. 5



## Selection Guide

### 接近开关

#### ■ 型号说明（圆柱形）

**P R [ ] [ ] [ ] [ ] 18 - 8 D N - [ ]**

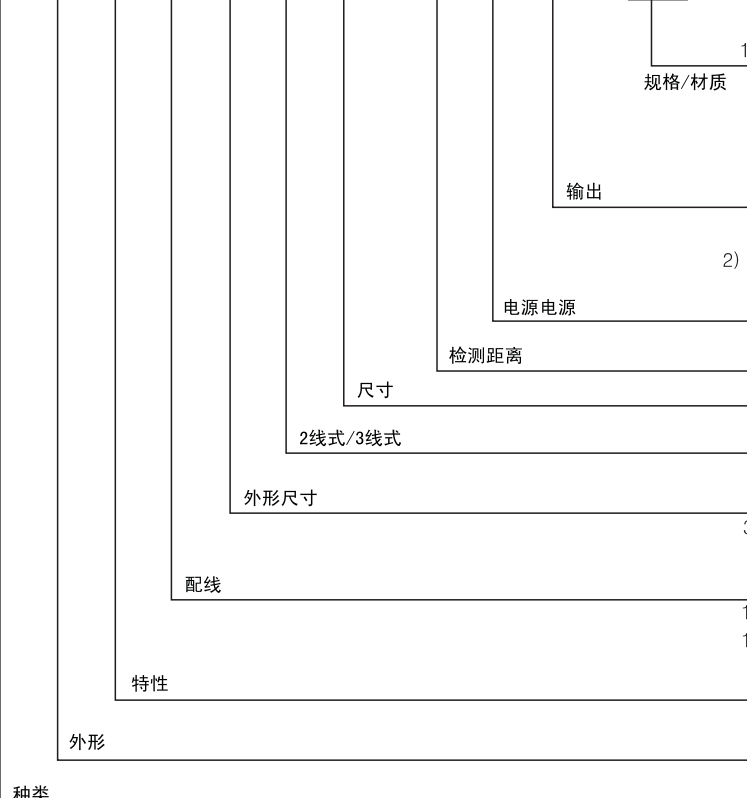

	标准型
1) I	IEC规格
V	耐油型线缆
IV	耐油型 (IEC规格)
N	NPN NO
N2	NPN NC
P	PNP NO
P2	PNP NC
2) O	常开
C	常闭
D	12-24VDC
A	100-240VAC
数字	标准检测距离 (mm)
数字	检测面直径 (mm)
T	直流3线式, 交流2线式
	直流2线式
3) S	标准型
L	短型
	长型
	配线引出型
1) CM	接插型
1) W	配线引出接插型
	标准型
A	防溅型
D	远距离检测型
R	圆柱形
P	电感式接近开关
C	电容式接近开关

- 1) 订购IEC规格的产品, 请在型号后加“1”。
- 2) 常开, 常闭 输出型仅指直流2线式和交流2线式产品。
- 3) Short Type 仅适用于PR12系列直流3线式产品。

#### ■ 型号说明（方形）

**P S [ ] 17 - 5 D N [ ] - [ ]**

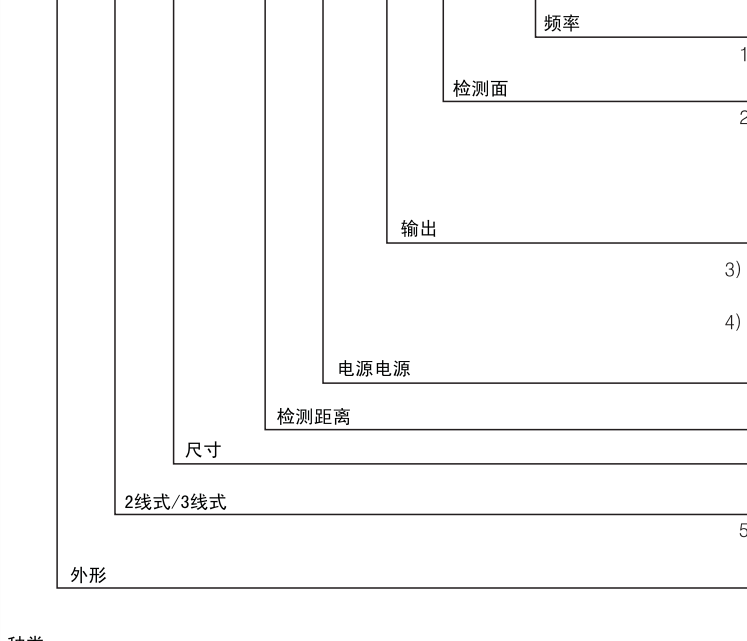

	标准型
1) F	双频率型
	标准型
2) U	上面检测型
N	NPN NO
N2	NPN NC
P	PNP NO
P2	PNP NC
3) O	常开
C	常闭
4) N3	NPN NO+NC
P3	PNP NO+NC
D	12-24VDC (AS Type: 12-48VDC)
A	100-240VAC
数字	标准检测距离 (mm)
数字	边长 (mm)
5) T	直流3线式, 交流2线式
	直流2线式
S	方形
SN	方形新型
FI	扁平型
P	电感式接近开关
A	电感式高性能接近开关

- 1) 双频率型产品仅指PSN17系列。
- 2) 上面检测型产品仅指PS12, PSN17系列。
- 3) 常开, 常闭 输出型仅指直流2线式和交流2线式产品。
- 4) N3, P3输出型仅指AS80系列产品。
- 5) 直流2线式产品指PSN17系列。

- 光电传感器
- 光纤传感器
- 门传感器 区域传感器
- 接近开关
- 压力传感器
- 旋转编码器
- 配线/配件
- 温度控制器
- SSR/功率控制器
- 计数器
- 计时器
- 电压/电流面板表
- 转速/线速脉冲表
- 显示单元
- 传感器控制器/开关电源
- 步进电机/驱动器/运动控制器
- 触摸屏
- 远程网络设备

## Selection Guide

### 接近开关

▣ 远距离直流2线式圆柱形（电源电压：12-24VDC）



外形	外形分类				型号	检测距离 (mm)		响应频率 (HZ)	
	标准型		长型			齐平	外露		
	齐平	外露	齐平	外露					
M12	标准型					PRDT12-4DO PRDT12-4DC	4	450	
						PRDT12-8DO PRDT12-8DC		8	400
						PRDLT12-4DO PRDLT12-4DC	4		450
						PRDLT12-8DO PRDLT12-8DC		8	400
	配线引出接插型					PRDWT12-4DO PRDWT12-4DC	4		450
						PRDWT12-8DO PRDWT12-8DC		8	400
M18	标准型					PRDT18-7DO PRDT18-7DC	7	250	
						PRDT18-14DO PRDT18-14DC		14	200
						PRDLT18-7DO PRDLT18-7DC	7		250
						PRDLT18-14DO PRDLT18-14DC		14	200
	接插型					PRDCMT18-7DO PRDCMT18-7DC	7		250
						PRDCMT18-14DO PRDCMT18-14DC		14	200
						PRDCMLT18-7DO PRDCMLT18-7DC	7		250
						PRDCMLT18-14DO PRDCMLT18-14DC		14	200
	配线引出接插型					PRDWT18-7DO PRDWT18-7DC	7		250
						PRDWT18-14DO PRDWT18-14DC		14	200
	防溅标准型					PRDAT18-7DO PRDAT18-7DC	7		250
	防溅配线引出接插型					PRDAWT18-7DO PRDAWT18-7DC	7		250
	M30	标准型					PRDT30-15DO PRDT30-15DC	15	100
							PRDT30-25DO PRDT30-25DC		25
						PRDLT30-15DO PRDLT30-15DC	15		100
						PRDLT30-25DO PRDLT30-25DC		25	100
接插型						PRDCMT30-15DO PRDCMT30-15DC	15		100
						PRDCMT30-25DO PRDCMT30-25DC		25	100
						PRDCMLT30-15DO PRDCMLT30-15DC	15		100
						PRDCMLT30-25DO PRDCMLT30-25DC		25	100
配线引出接插型						PRDWT30-15DO PRDWT30-15DC	15		100
						PRDWT30-25DO PRDWT30-25DC		25	100
防溅标准型						PRDAT30-15DO PRDAT30-15DC	15		100
防溅配线引出接插型						PRDAWT30-15DO PRDAWT30-15DC	15		100

▶ IEC连接类型另售，订货是在型号后加-I以注明

## Selection Guide

### 接近开关

■ 直流2线式圆柱形（电源电压：12-24VDC）



外形	外形分类				型号	检测距离 (mm)		响应频率 (HZ)
	标准型		长型			齐平	外露	
	齐平	外露	齐平	外露				
M08	标准型				PRT08-1.5DO PRT08-1.5DC	1.5		1500
					PRT08-2DO PRT08-2DC		2	1000
	配线引出接插型				PRWT08-1.5DO PRWT08-1.5DC	1.5		1500
					PRWT08-2DO PRWT08-2DC		2	1000
M12	标准型				PRT12-2DO PRT12-2DC	2		1500
					PRT12-4DO PRT12-4DC		4	500
	接插型				PRCMT12-2DO PRCMT12-2DC	2		1500
					PRCMT12-4DO PRCMT12-4DC		4	500
	配线引出接插型				PRWT12-2DO PRWT12-2DC	2		1500
					PRWT12-4DO PRWT12-4DC		4	500
	防溅标准型				PRAT12-2DO PRAT12-2DC	2		1500
	防溅配线引出接插型				PRAWT12-2DO PRAWT12-2DC	2		1500
M18	标准型				PRT18-5DO PRT18-5DC	5		500
					PRT18-8DO PRT18-8DC		8	350
	接插型				PRCMT18-5DO PRCMT18-5DC	5		500
					PRCMT18-8DO PRCMT18-8DC		8	350
	配线引出接插型				PRWT18-5DO PRWT18-5DC	5		500
					PRWT18-8DO PRWT18-8DC		8	350
	防溅标准型				PRAT18-5DO PRAT18-5DC	5		500
	防溅配线引出接插型				PRAWT18-5DO PRAWT18-5DC	5		500
M30	标准型				PRT30-10DO PRT30-10DC	10		400
					PRT30-15DO PRT30-15DC		15	200
	接插型				PRCMT30-10DO PRCMT30-10DC	10		400
					PRCMT30-15DO PRCMT30-15DC		15	200
	配线引出接插型				PRWT30-10DO PRWT30-10DC	10		400
					PRWT30-15DO PRWT30-15DC		15	200
	防溅标准型				PRAT30-10DO PRAT30-10DC	10		400
	防溅配线引出接插型				PRAWT30-10DO PRAWT30-10DC	10		400

▶ IEC连接类型另售，订货是在型号后加-I以注明

光电传感器

光纤传感器

门传感器  
区域传感器

接近开关

压力传感器

旋转编码器

配线/配件

温度控制器

SSR/功率控制器

计数器

计时器

电压/电流面板表

转速/线速脉冲表

显示单元

传感器控制器/开关电源

步进电机/驱动器/运动控制器

触摸屏

远程网络设备

## Selection Guide

### 接近开关

▣ 远距离直流3线式圆柱形 (电源电压: 12-24VDC)



外形	外形分类				型号	检测距离 (mm)		响应频率 (HZ)	
	标准型		长型			齐平	外露		
	齐平	外露	齐平	外露					
M12	标准型					4		500	
								8	400
							4		500
								8	400
	接插型						4		500
								8	400
							4		500
								8	400
	配线引出接插型						4		500
								8	400
							4		500
								8	400
M18	标准型					7		300	
							14	200	
							7		300
								14	200
	接插型						7		300
								14	200
							7		300
								14	200
	配线引出接插型						7		300
								14	200
							7		300
								14	200

Selection Guide

接近开关

▣ 远距离直流3线式圆柱形 (电源电压: 12-24VDC)



外形	外形分类				型号	检测距离 (mm)		响应频率 (HZ)	
	标准型		长型			齐平	外露		
	齐平	外露	齐平	外露					
M30	标准型					PRD30-15DN PRD30-15DP PRD30-15DN2 PRD30-15DP2	15		100
						PRD30-25DN PRD30-25DP PRD30-25DN2 PRD30-25DP2		25	100
						PRDL30-15DN PRDL30-15DP PRDL30-15DN2 PRDL30-15DP2	15		100
						PRDL30-25DN PRDL30-25DP PRDL30-25DN2 PRDL30-25DP2		25	100
	接插型					PRDCM30-15DN PRDCM30-15DP PRDCM30-15DN2 PRDCM30-15DP2	15		100
						PRDCM30-25DN PRDCM30-25DP PRDCM30-25DN2 PRDCM30-25DP2		25	100
						PRDCML30-15DN PRDCML30-15DP PRDCML30-15DN2 PRDCML30-15DP2	15		100
						PRDCML30-25DN PRDCML30-25DP PRDCML30-25DN2 PRDCML30-25DP2		25	100
配线引出接插型					PRDW30-15DN PRDW30-15DP PRDW30-15DN2 PRDW30-15DP2	15		100	
					PRDW30-25DN PRDW30-25DP PRDW30-25DN2 PRDW30-25DP2		25	100	
					PRDWL30-15DN PRDWL30-15DP PRDWL30-15DN2 PRDWL30-15DP2	15		100	
					PRDWL30-25DN PRDWL30-25DP PRDWL30-25DN2 PRDWL30-25DP2		25	100	

光电传感器

光纤传感器

门传感器/区域传感器

接近开关

压力传感器

旋转编码器

配线/配件

温度控制器

SSR/功率控制器

计数器

计时器

电压/电流面板表

转速/线速脉冲表

显示单元

传感器控制器/开关电源

步进电机/驱动器/运动控制器

触摸屏

远程网络设备



## Selection Guide

### 接近开关

■ 直流3线式圆柱形（电源电压：12-24VDC）



外形	外形分类				型号	检测距离 (mm)		响应频率 (HZ)	
	标准型		长型			齐平	外露		
	齐平	外露	齐平	外露					
M08	标准型				PR08-1.5DN PR08-1.5DP PR08-1.5DN2 PR08-1.5DP2	1.5		1500	
					PR08-2DN PR08-2DP PR08-2DN2 PR08-2DP2		2	1000	
						PRL08-1.5DN PRL08-1.5DP PRL08-1.5DN2 PRL08-1.5DP2	1.5		1500
						PRL08-2DN PRL08-2DP PRL08-2DN2 PRL08-2DP2		2	1000
	配线引出接插型				PRW08-1.5DN PRW08-1.5DP PRW08-1.5DN2 PRW08-1.5DP2	1.5		1500	
					PRW08-2DN PRW08-2DP PRW08-2DN2 PRW08-2DP2		2	1000	
						PRWL08-1.5DN PRWL08-1.5DP PRWL08-1.5DN2 PRWL08-1.5DP2	1.5		1500
						PRWL08-2DN PRWL08-2DP PRWL08-2DN2 PRWL08-2DP2		2	1000
M12	标准型				PRS12-2DN PRS12-2DP PRS12-2DN2 PRS12-2DP2	2		1500	
					PRS12-4DN PRS12-4DP PRS12-4DN2 PRS12-4DP2		4	500	
					PR12-2DN PR12-2DP PR12-2DN2 PR12-2DP2	2		1500	
					PR12-4DN PR12-4DP PR12-4DN2 PR12-4DP2		4	500	
					PRL12-4DN PRL12-4DP		4	500	
	接插型				PRCM12-2DN PRCM12-2DP PRCM12-2DN2 PRCM12-2DP2	2		1500	
					PRCM12-4DN PRCM12-4DP PRCM12-4DN2 PRCM12-4DP2		4	500	
	配线引出接插型				PRW12-2DN PRW12-2DP PRW12-2DN2 PRW12-2DP2	2		1500	
					PRW12-4DN PRW12-4DP PRW12-4DN2 PRW12-4DP2		4	500	
	防溅型				PRA12-2DN PRA12-2DP PRA12-2DN2 PRA12-2DP2	2		1500	
	M18	标准型				PR18-5DN PR18-5DP PR18-5DN2 PR18-5DP2	5		500
						PR18-8DN PR18-8DP PR18-8DN2 PR18-8DP2		8	350
						PRL18-5DN PRL18-5DP PRL18-5DN2 PRL18-5DP2	5		500
						PRL18-8DN PRL18-8DP PRL18-8DN2 PRL18-8DP2		8	350
接插型					PRCM18-5DN PRCM18-5DP PRCM18-5DN2 PRCM18-5DP2	5		500	
					PRCM18-8DN PRCM18-8DP PRCM18-8DN2 PRCM18-8DP2		8	350	

Selection Guide

接近开关

■ 直流3线式圆柱形 (电源电压: 12-24VDC)



外形	外形分类				型号	检测距离 (mm)		响应频率 (HZ)									
	标准型		长型			齐平	外露										
	齐平	外露	齐平	外露													
M18	接插型					5		500									
									8	350							
											5	500					
													8	350			
															5	500	
																	8
	配线引出接插型					5	500										
								8	350								
										5	500						
												8	350				
														10	400		
																15	200
	M30	标准型					10										
								15	200								
										10	400						
												15	200				
														10	400		
																15	200
接插型						10	400										
								15	200								
										10	400						
												15	200				
														10	400		
																15	200
配线引出接插型						10	400										
								15	200								
										10	400						
												15	200				
														10	400		
																15	200
防溅型					10	400											
							15	200									
									10	400							
											15	200					
													10	400			
															15	200	

- 光电传感器
- 光纤传感器
- 门传感器/区域传感器
- 接近开关
- 压力传感器
- 旋转编码器
- 配线/配件
- 温度控制器
- SSR/功率控制器
- 计数器
- 计时器
- 电压/电流面板表
- 转速/线速脉冲表
- 显示单元
- 传感器控制器/开关电源
- 步进电机/驱动器/运动控制器
- 触摸屏
- 远程网络设备



## Selection Guide

### 接近开关

■交流2线式圆柱形（电源电压：100-240VAC）



外形	外形分类				型号	检测距离 (mm)		响应频率 (HZ)		
	标准型		长型			齐平	外露			
	齐平	外露	齐平	外露						
M12	标准型						2	20		
	接插型							4		
	配线引出接插型							2		
	防溅型							4		
	M18	标准型						2	20	
										2
								5		
接插型								8		
								5		
								8		
								5		
配线引出接插型								8		
								5		
								8		
								5		
防溅型								8		
								5		
								8		
								5		
M30	标准型						10	20		
									15	
									10	
									15	
	接插型							10		
								15		
								10		
								15		
	配线引出接插型							10		
								15		
								10		
								15		
	防溅型							10		

## Selection Guide

### 接近开关





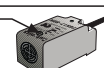



#### ▣直流2线式方形（电源电压：12-24VDC）

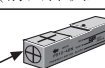

		外形		型号	检测距离 (mm)	响应频率 (Hz)
分类		标准型（前面探测型）	上面探测型			
17 方形	标准型	前面检测型 (标准型) 		PSNT17-5DO	5	500
				PSNT17-5DC		
			上面检测型 (U型) 	PSNT17-5DOU		
				PSNT17-5DCU		

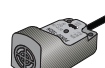
#### ▣直线3线式方形（电源电压：12-24VDC）

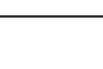
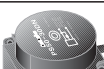

		外形		型号	检测距离 (mm)	响应频率 (Hz)
分类		标准型（前面探测型）	上面探测型			
12 方形	标准型	前面检测型 (标准型) 		PS12-4DN	4	500
				PS12-4DP		
				PS12-4DN2		
			上面检测型 (U型) 	PS12-4DNU		
				PS12-4DPU		
				PS12-4DN2U		
17 方形	标准型	前面检测型 (标准型) 		PSN17-5DN	5	700
				PSN17-5DP		
				PSN17-5DN2		
				PSN17-5DP2		
				PSN17-5DN-F		
				PSN17-8DN		
				PSN17-8DP		
				PSN17-8DN2		
				PSN17-8DN-F		
			上面检测型 (U型) 	PSN17-5DNU		
				PSN17-5DPU		
				PSN17-5DN2U		
				PSN17-5DP2U		
				PSN17-8DNU		
				PSN17-8DPU		
				PSN17-8DN2U		
				PSN17-8DNU-F		
				PSN17-8DPU-F		
PSN17-8DN2U-F						
25 方形	标准型			PSN25-5DN	5	350
				PSN25-5DP		
				PSN25-5DN2		
				PSN25-5DP2		
30 方形	标准型			PFI25-8DN	8	200
				PFI25-8DP		
				PFI25-8DN2		
				PFI25-8DP2		
40 方形	标准型			PSN30-10DN	10	250
				PSN30-10DP		
				PSN30-10DN2		
				PSN30-10DP2		
50 方形	标准型			PSN30-15DN	15	200
				PSN30-15DP		
				PSN30-15DN2		
				PSN30-15DP2		
50 方形	标准型			PSN40-20DN	20	100
				PSN40-20DP		
				PSN40-20DN2		
				PSN40-20DP2		
50 方形	标准型			PS50-30DN	30	50
				PS50-30DP		
				PS50-30DN2		
				PS50-30DP2		

光电  
传感器

光纤  
传感器

门传感器  
区域传感器

接近开关

压力  
传感器

旋转  
编码器

配线/  
配件

温度  
控制器

SSR/  
功率  
控制器

计数器

计时器

电压/  
电流  
面板表

转速/  
线速  
脉冲表

显示单元

传感器  
控制器/  
开关电源

步进电机/  
驱动器/  
运动控制  
器

触摸屏

远程网络  
设备

## Selection Guide

### 接近开关



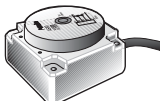

#### ■ 直流4线式方形 (电源电压: 12-48VDC)



外形			型号	检测距离 (mm)	响应频率 (Hz)
分类	标准型 (前面探测)	上面检测型			
80 方型	标准型	长距离探测型 	AS80-50DN3	50	100
			AS80-50DP3		

#### ■ 交流2线式方型 (电源电压: 100-240VAC)



外形			型号	检测距离 (mm)	响应频率 (Hz)
分类	标准型 (前面探测)	上面检测型			
25 方型	标准型		PSN25-5AO	5	20
			PSN25-5AC		
	扁平型		PFI25-8AO	8	
			PFI25-8AC		
30 方型	标准型		PSN30-10AO	10	
			PSN30-10AC		
			PSN30-15AO	15	
			PSN30-15AC		
40 方型	标准型		PSN40-20AO	20	
			PSN40-20AC		

#### ■ 电容式直流3线圆柱型 (电源电压: 12-24VDC)

外形		外形分类				型号	检测距离 (mm)		响应频率 (Hz)
		标准型		长型			齐平	外露	
		齐平	外露	齐平	外露				
M18	标准型					8		50	
			CR18-8DN						
			CR18-8DP						
M30	标准型					15			
			CR18-8DN2 *						
			CR30-15DN						
			CR30-15DP						
			CR30-15DN2 *						

▶ \* 标记的是可选的

#### ■ 电容式交流2线型 (电源电压: 100-240VAC)

外形		外形分类				型号	检测距离 (mm)		响应频率 (Hz)
		标准型		长型			齐平	外露	
		齐平	外露	齐平	外露				
M18	标准型					8		20	
			CR18-8AO						
M30	标准型					15			
			CR18-8AC						
			CR30-15AO						
			CR30-15AC						

#### ■ 传送耦合器

外形		外形分类				型号	传送距离 (mm)		响应频率 (Hz)
		标准型		长型			齐平	外露	
		齐平	外露	齐平	外露				
M18	标准型					PET18-5	5		

\* 适合的传感器类型: PRT18-5D□, PRCMT18-5D□, PR18-5D□, PRCM18-5D□, PRL18-5D□, PRCML18-5D□.

# Selection Guide

## 接近开关

### ■ 电缆引出型尺寸

(单位:mm)

#### ●M08

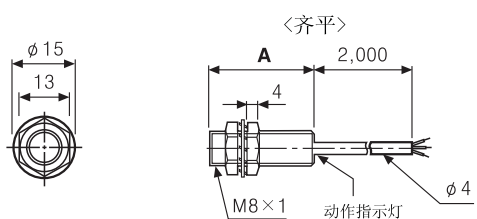

型号	A
PRT08-1.5D□	30
PR08-1.5D□	30
PRL08-1.5D□	40

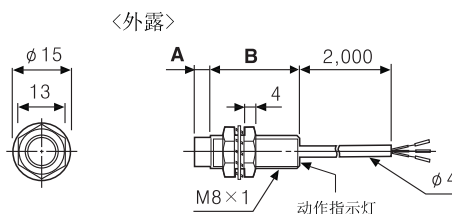

型号	A	B
PRT08-2D□	4	26
PR08-2D□	4	26
PRL08-2D□	4	36

#### ●M12

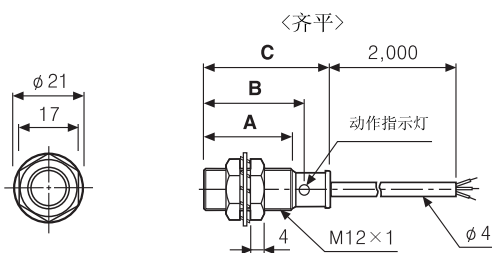

型号	A	B	C
PRS12-2D□	24.5	28.5	35.5
PRT12-2D□	31.5	35.5	42.5
PR12-2D□	31.5	35.5	42.5
PR12-2A□	48.5	52.5	59.5

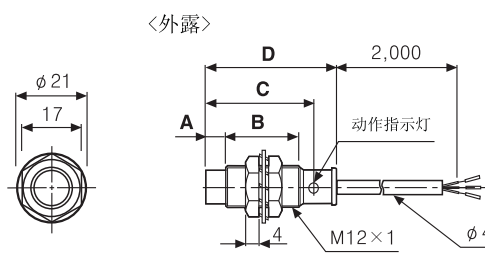

型号	A	B	C	D
PRS12-4D□	7	17.5	28.5	35.5
PRT12-4D□	7	24.5	35.5	42.5
PRL12-4D□	7	37.0	48.0	55.0
PR12-4D□	7	24.5	35.5	42.5
PRS12-8D□	7	24.5	35.5	42.5
PR12-4A□	7	41.5	52.5	59.5

#### ●M12

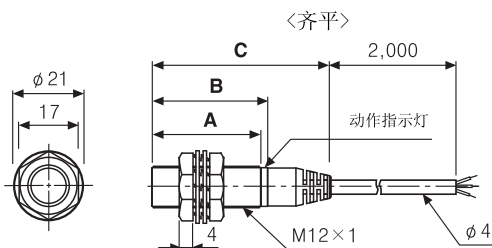

型号	A	B	C
PRDT12-4D□	31.5	33.5	51.8
PRD12-4D□	31.5	33.5	51.8
PRDLT12-4D□	44.0	46.0	64.3
PRDL12-4D□	44.0	46.0	64.3

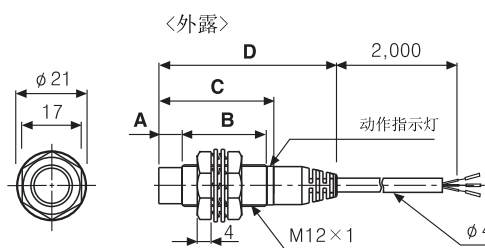

型号	A	B	C	D
PRDT12-8D□	7	24.5	23.5	51.8
PRD12-8D□	7	24.5	35.5	51.8
PRDLT12-8D□	7	37.0	46.0	64.3
PRDL12-8D□	7	37.0	46.0	64.3

#### ●M18

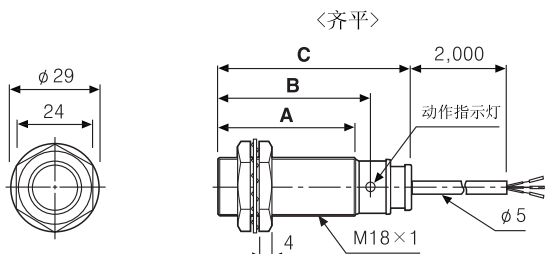

型号	A	B	C
PRT18-5D□	29.0	33.5	47.0
PR18-5D□	29.0	33.5	47.0
PR18-5A□	35.3	39.8	53.3
PRL18-5D□	62.0	66.5	80.0
PRL18-5A□	62.0	66.5	80.0

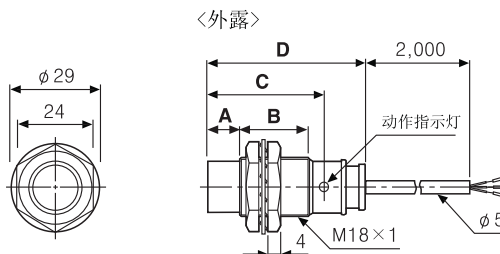

型号	A	B	C	D
PRT18-8D□	10	19.0	33.5	47.0
PR18-8D□	10	19.0	33.5	47.0
PR18-8A□	10	25.3	39.8	53.3
PRL18-8D□	10	52.0	66.5	80.0
PRL18-8A□	10	52.0	66.5	80.0

光电传感器

光纤传感器

门传感器  
区域传感器

接近开关

压力传感器

旋转编码器

配线/配件

温度控制器

SSR/  
功率控制器

计数器

计时器

电压/  
电流  
面板表

转速/  
线速  
脉冲表

显示单元

传感器  
控制器/  
开关电源

步进电机/  
驱动器/  
运动控制器

触摸屏

远程网络  
设备

## Selection Guide

### 接近开关

#### ▣ 电缆引出型尺寸

(单位:mm)

##### ●M18

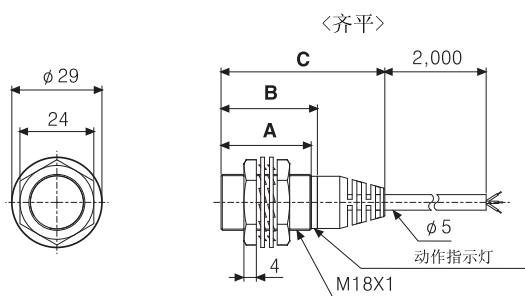

型号	A	B	C
PRDT18-7D□	29.5	31.5	53.2
PRD18-7D□	29.5	31.5	53.2
PRDLT18-7D□	62.0	64.0	85.7
PRDL18-7D□	62.0	64.0	85.7

##### ●M18

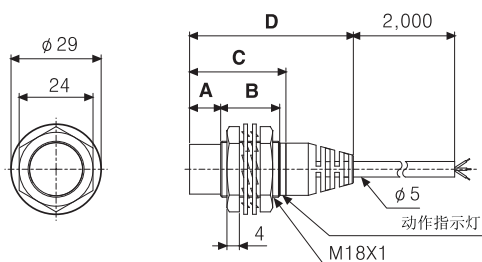

型号	A	B	C	D
PRDT18-14D□	10	19.0	31.0	52.7
PRD18-14D□	10	19.0	31.0	52.7
PRDLT18-14D□	10	52.0	64.0	85.7
PRDL18-14D□	10	52.0	64.0	85.7

##### ●M30

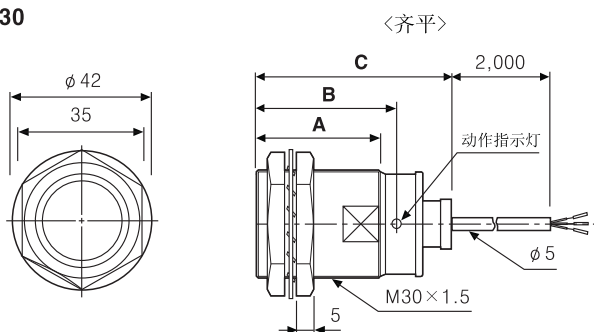

型号	A	B	C
PRT30-10D□	38.0	43.0	58.0
PR30-10D□	38.0	43.0	58.0
PR30-10A□	38.0	43.0	58.0
PRL30-10D□	60.0	65.0	80.0
PRL30-10A□	60.0	65.0	80.0

##### ●M30

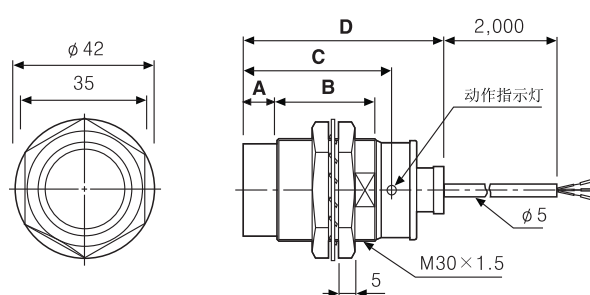

型号	A	B	C	D
PRT30-15D□	10	28.0	43.0	58.0
PR30-15D□	10	28.0	43.0	58.0
PR30-15A□	10	28.0	43.0	58.0
PRL30-15D□	10	50.0	65.0	80.0
PRL30-15A□	10	50.0	65.0	80.0

##### ●M30

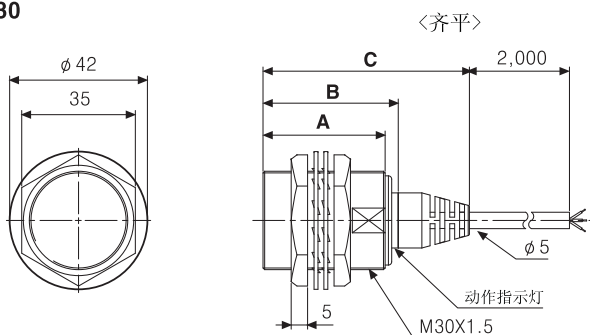

型号	A	B	C
PRDT30-15D□	38.0	40.3	62.0
PRD30-15D□	38.0	40.3	62.0
PRDLT30-15D□	60.0	62.3	84.0
PRDL30-15D□	60.0	62.3	84.0

##### ●M30

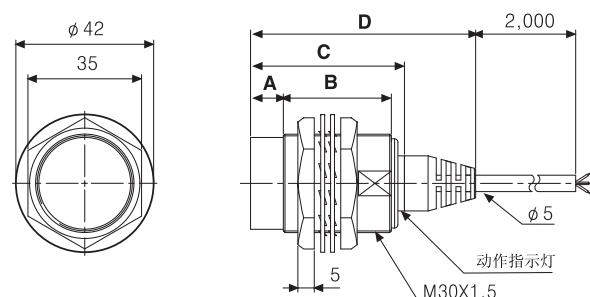

型号	A	B	C	D
PRDT30-25D□	10	28.0	40.3	62.0
PRD30-25D□	10	28.0	40.3	62.0
PRDLT30-25D□	10	50.0	62.3	84.0
PRDL30-25D□	10	50.0	62.3	84.0

#### ▣ 防溅型尺寸

(单位:mm)

##### ●PRA12-2D □ ●PRAT12-2D □ ●PRAWT12-2D □

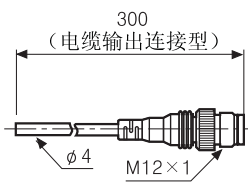
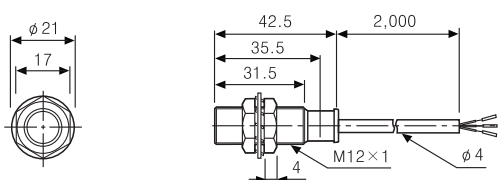

##### ●PRA12-2A □

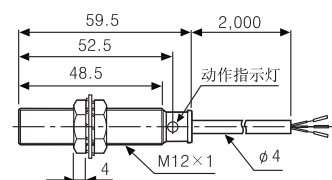

# Selection Guide

## 接近开关

### 防溅型尺寸

(单位:mm)

●PRA18-5D □ ●PRAT18-5D □ ●PRAWT18-5D □

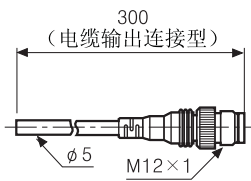
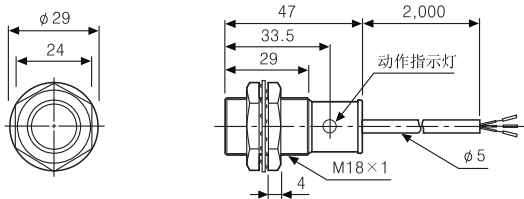

●PRA18-5A □

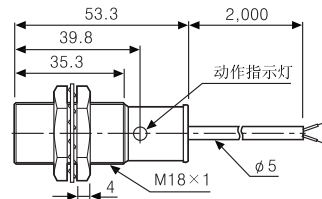

●PRA30-10D □ ●PRAT30-10D □ ●PRAWT30-10D □

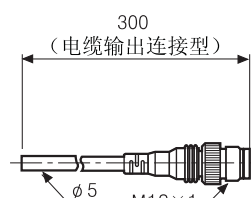
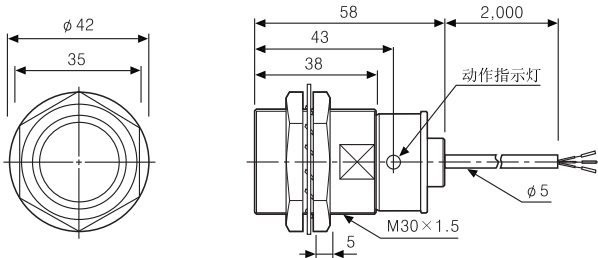

●PRA30-10A □

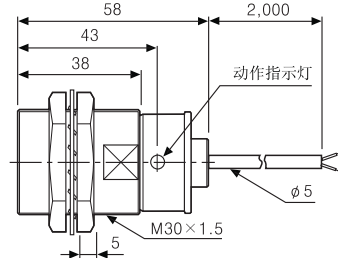

●PRDAT18-7D □

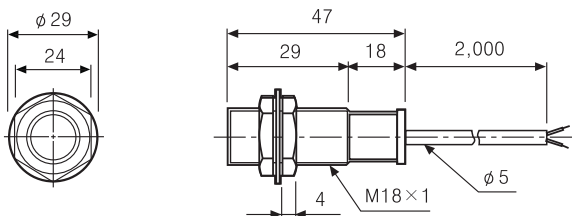

●PRDAWT18-7D □

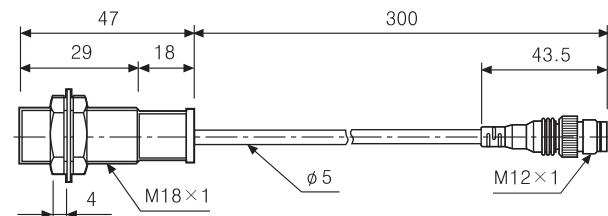

●PRDAT30-15D □

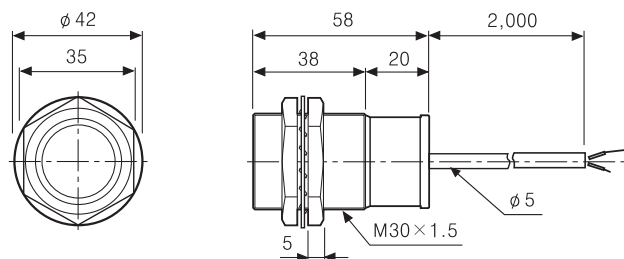

●PRDAWT30-15D □

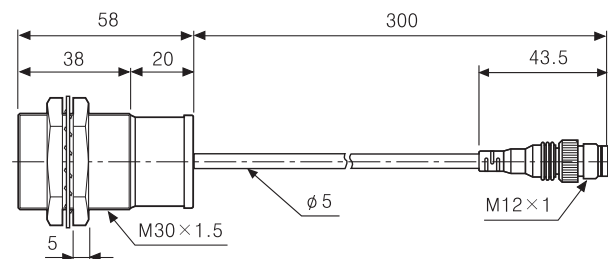

### 接插型尺寸

●M12

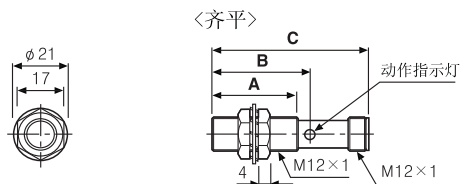

型号	A	B	C
PRCMT12-2D □	31.5	35.5	55.8
PRCM12-2D □	31.5	35.5	55.8
PRCM12-2A □	48.5	52.5	72.8

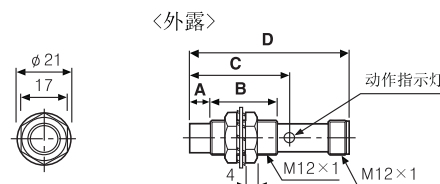

型号	A	B	C	D
PRCMT12-4D □	7	24.5	35.5	55.8
PRCM12-4D □	7	24.5	35.5	55.8
PRCM12-4A □	7	41.5	52.5	72.8

●M12

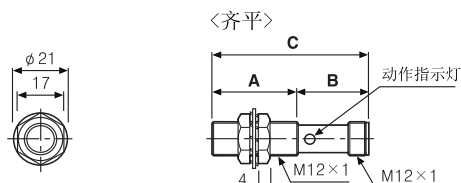

型号	A	B	C
PRDCMT12-4D □	31.5	24.3	55.8
PRDCM12-4D □	31.5	24.3	55.8
PRDCMLT12-4D □	44.0	24.3	68.3
PRDCML12-4D □	44.0	24.3	68.3

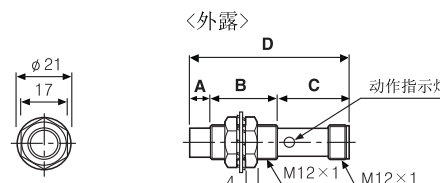

型号	A	B	C	D
PRDCMT12-8D □	7	24.5	24.3	55.8
PRDCM12-8D □	7	24.5	24.3	55.8
PRDCMLT12-8D □	7	37.0	24.3	68.3
PRDCML12-8D □	7	37.0	24.3	68.3



## Selection Guide

### 接近开关

#### ■ 接插型尺寸

(单位:mm)

##### ●M18

<齐平>

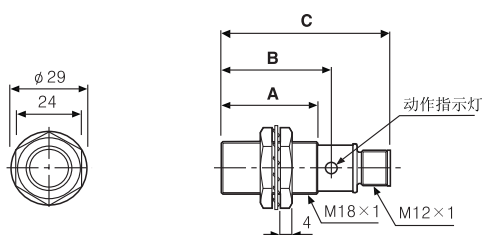

型号	A	B	C
PRCMT18-5D□	29.0	33.5	53.8
PRCM18-5D□	29.0	33.5	53.8
PRCM18-5A□	35.3	39.5	60.1
PRCML18-5D□	62.0	66.5	86.8
PRCML18-5A□	62.0	66.5	86.8

<外露>

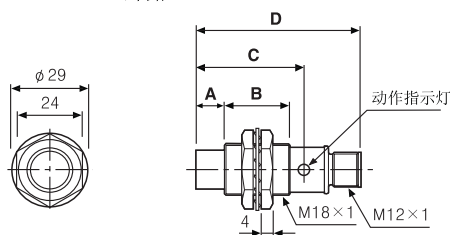

型号	A	B	C	D
PRCMT18-8D□	10	19.0	33.5	53.8
PRCM18-8D□	10	19.0	33.5	53.8
PRCM18-8A□	10	25.3	39.5	60.1
PRCML18-8D□	10	52.0	66.5	86.8
PRCML18-8A□	10	52.0	66.5	86.8

##### ●M18

<齐平>

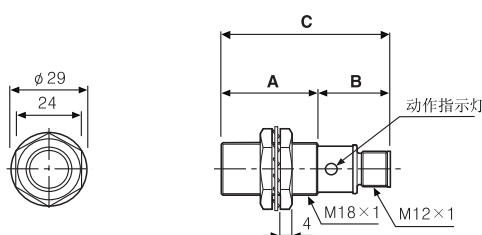

型号	A	B	C
PRDCMT18-7D□	29.5	24.8	54.3
PRDCM18-7D□	29.5	24.8	54.3
PRDCML18-7D□	62.5	24.8	87.3
PRDCML18-7D□	62.5	24.8	87.3

<外露>

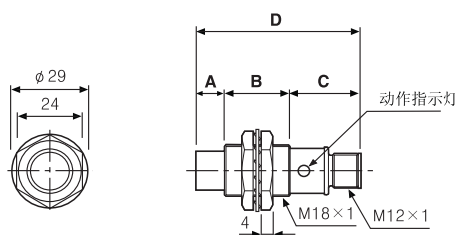

型号	A	B	C	D
PRDCMT18-14D□	10	19.0	24.8	53.8
PRDCM18-14D□	10	19.0	24.8	53.8
PRDCML18-14D□	10	52.0	24.8	86.8
PRDCML18-14D□	10	52.0	24.8	86.8

##### ●M30

<齐平>

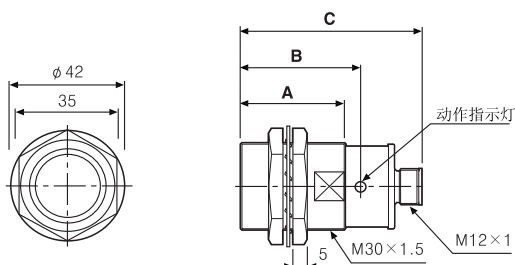

型号	A	B	C
PRCMT30-10D□	38.0	43.0	63.8
PRCM30-10D□	38.0	43.0	63.8
PRCM30-10A□	38.0	43.0	63.8
PRCML30-10D□	60.0	65.0	85.8
PRCML30-10A□	60.0	65.0	85.8

<外露>

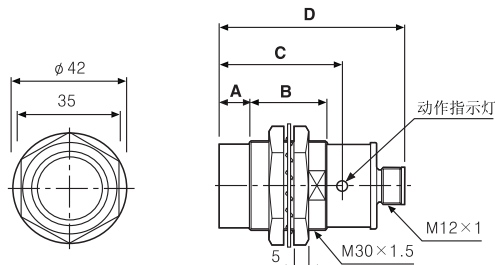

型号	A	B	C	D
PRCMT30-15D□	10	28.0	43.0	63.8
PRCM30-15D□	10	28.0	43.0	63.8
PRCM30-15A□	10	28.0	43.0	63.8
PRCML30-15D□	10	50.0	65.0	85.8
PRCML30-15A□	10	50.0	65.0	85.8

##### ●M30

<齐平>

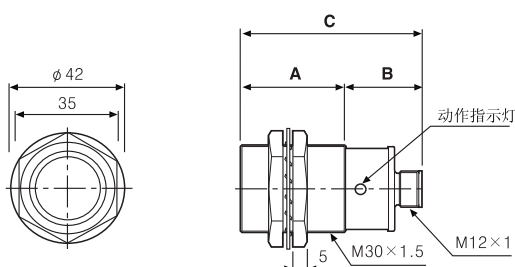

型号	A	B	C
PRDCMT30-15D□	38.0	25.8	63.8
PRDCM30-15D□	38.0	25.8	63.8
PRDCML30-15D□	60.0	25.8	85.8
PRDCML30-15D□	60.0	25.8	85.8

<外露>

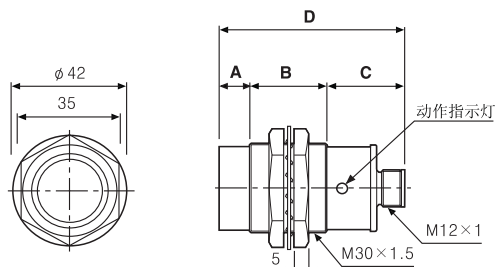

型号	A	B	C	D
PRDCMT30-25D□	10	28.0	25.8	63.8
PRDCM30-25D□	10	28.0	25.8	63.8
PRDCML30-25D□	10	50.0	25.8	85.8
PRDCML30-25D□	10	50.0	25.8	85.8

# Selection Guide

## 接近开关

### ■ 电缆引出接插型尺寸

(单位:mm)

#### ●M08

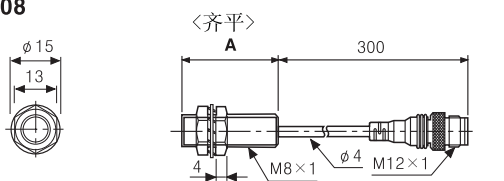

型号	A
PRWT08-1.5D□	30
PRW08-1.5D□	30
PRWL08-1.5D□	40

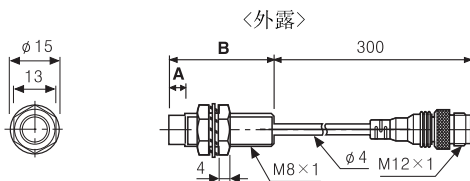

型号	A	B
PRWT08-2D□	4	30
PRW08-2D□	4	30
PRWL08-2D□	4	30

#### ●M12

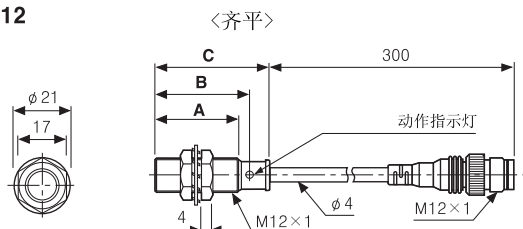

型号	A	B	C
PRWT12-2D□	31.5	35.5	42.5
PRW12-2D□	31.5	35.5	42.5
PRW12-2A□	48.5	52.5	59.5

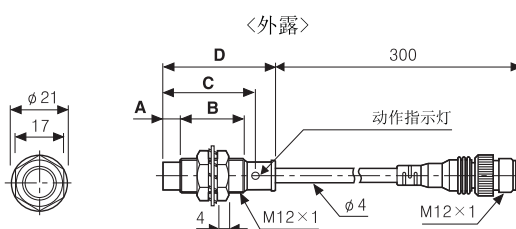

型号	A	B	C	D
PRWT12-4D□	7	24.5	35.5	42.5
PRW12-4D□	7	24.5	35.5	42.5
PRW12-4A□	7	41.5	52.5	59.5

#### ●M12

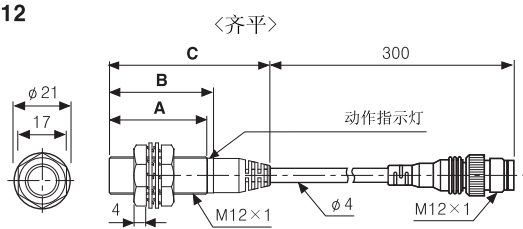

型号	A	B	C
PRDWT12-4D□	31.5	33.5	51.8
PRDW12-4D□	31.5	33.5	51.8
PRDWL12-4D□	44.0	46.0	64.3

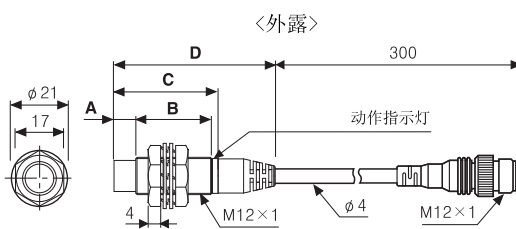

型号	A	B	C	D
PRDWT12-7D□	7	24.5	33.5	51.8
PRDW12-7D□	7	24.5	33.5	51.8
PRDWL12-7D□	7	37.0	46.0	64.3

#### ●M18

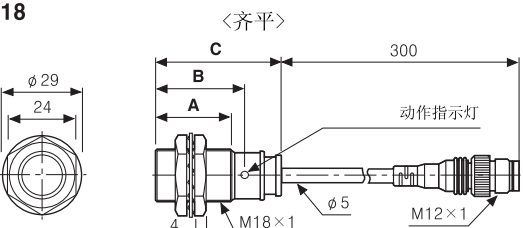

型号	A	B	C
PRWT18-5D□	29.0	33.5	47.0
PRW18-5D□	29.0	33.5	47.0
PRW18-5A□	35.3	39.8	53.5
PRWL18-5D□	62.0	66.5	80.0
PRWL18-5A□	62.0	66.5	80.0

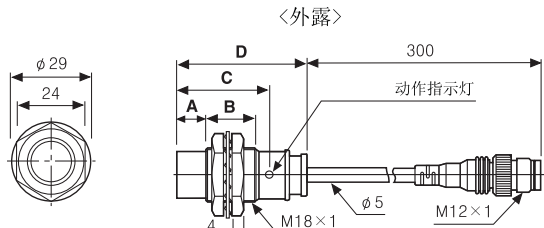

型号	A	B	C	D
PRWT18-8D□	10	19.0	33.5	47.0
PRW18-8D□	10	19.0	33.5	47.0
PRW18-8A□	10	25.3	39.8	53.5
PRWL18-8D□	10	52.0	66.5	80.0
PRWL18-8A□	10	52.0	66.5	80.0

#### ●M18

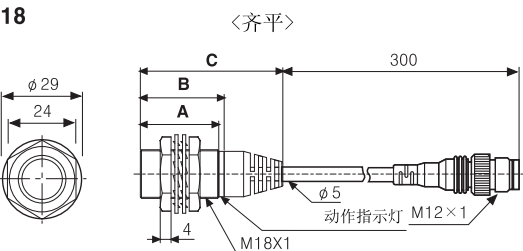

型号	A	B	C
PRDWT18-7D□	38.5	40.5	62.2
PRDW18-7D□	38.5	40.5	62.2
PRDWL18-7D□	62.0	64.0	85.7
PRDWL18-7D□	62.0	64.0	85.7

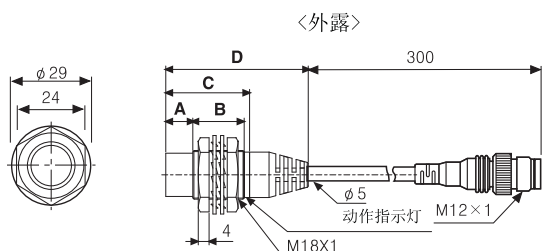

型号	A	B	C	D
PRDWT18-14D□	10	29.0	41.0	62.7
PRDW18-14D□	10	29.0	41.0	62.7
PRDWL18-14D□	10	52.0	64.0	85.7
PRDWL18-14D□	10	52.0	64.0	85.7

- 光电传感器
- 光纤传感器
- 门传感器  
区域传感器
- 接近开关
- 压力传感器
- 旋转编码器
- 配线/配件
- 温度控制器
- SSR/功率控制器
- 计数器
- 计时器
- 电压/电流面板表
- 转速/线速脉冲表
- 显示单元
- 传感器控制器/开关电源
- 步进电机/驱动器/运动控制器
- 触摸屏
- 远程网络设备

## Selection Guide

### 接近开关

#### ■ 电缆引出接插型尺寸

(单位:mm)

##### ●M30

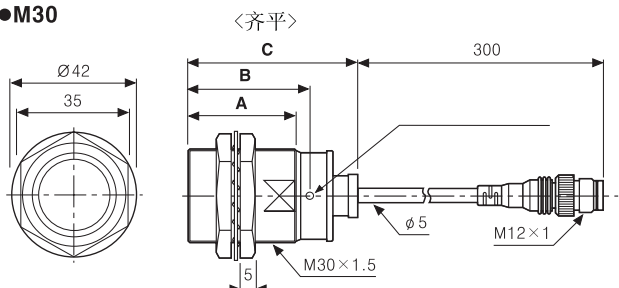

型号	A	B	C
PRWT30-10D□	38.0	43.0	58.0
PRW30-10D□	38.0	43.0	58.0
PRW30-10A□	38.0	43.0	58.0
PRWL30-10D□	60.0	65.0	80.0
PRWL30-10A□	60.0	65.0	80.0

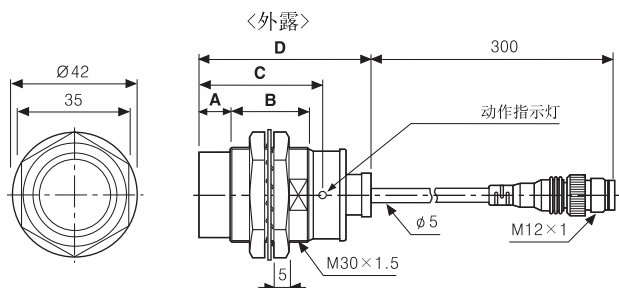

型号	A	B	C	D
PRWT30-15D□	10	28.0	43.0	58.0
PRW30-15D□	10	28.0	43.0	58.0
PRW30-15A□	10	28.0	43.0	58.0
PRWL30-15D□	10	50.0	65.0	80.0
PRWL30-15A□	10	50.0	65.0	80.0

##### ●M30

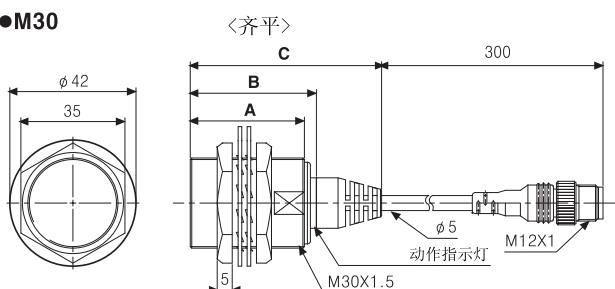

型号	A	B	C
PRDWT30-10D□	38.0	40.3	62.0
PRDW30-10D□	38.0	40.3	62.0
PRDWLT30-10D□	60.0	62.3	84.0
PRDWL30-10D□	60.0	62.3	84.0

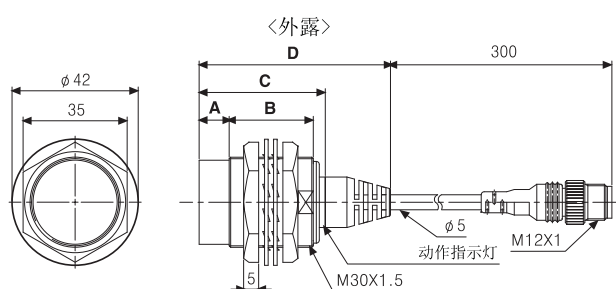

型号	A	B	C	D
PRWT30-15D□	10	28.0	40.3	62.0
PRW30-15D□	10	28.0	40.3	62.0
PRWLT30-15D□	10	50.0	62.3	84.0
PRWL30-15D□	10	50.0	62.3	84.0

#### ■ 方形尺寸

(单位:mm)

##### ●PS12-4D□

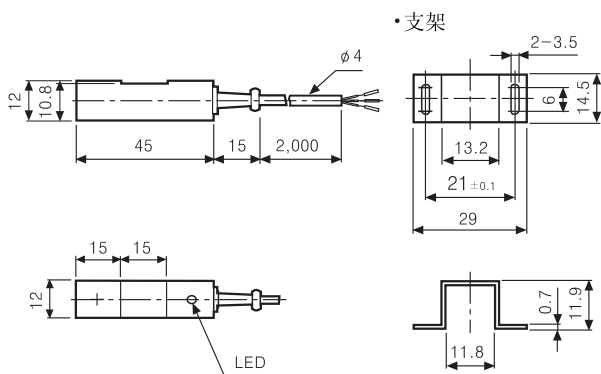

##### ●PSN25-5D□

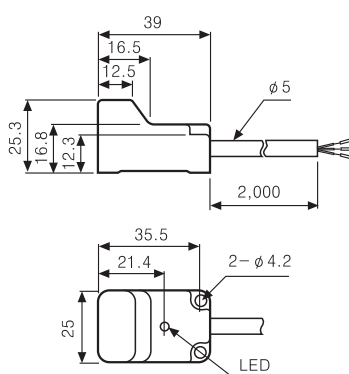

##### ●PSN25-5A□

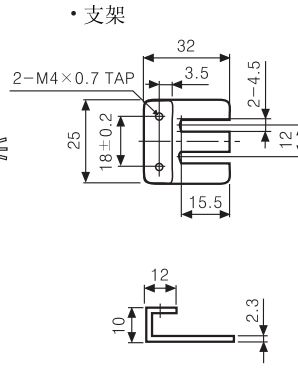

##### ●PSN17-5(8)D□

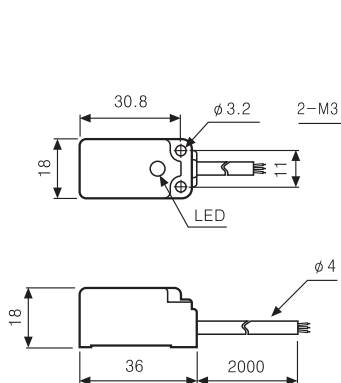

##### ●PSNT17-5D□

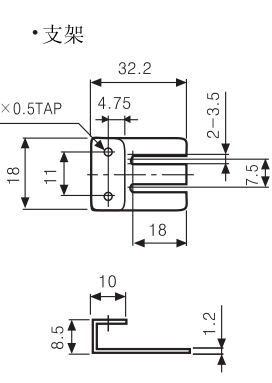

##### ●PSN30-10(15)D□

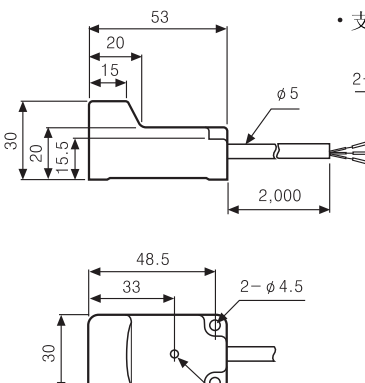

##### ●PSN30-10(15)A□

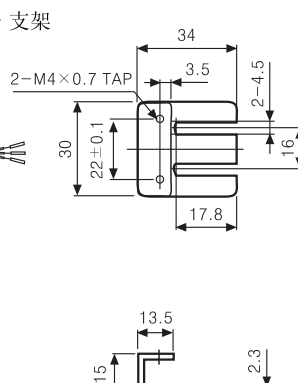

## Selection Guide

### 接近开关

#### ■ 方形尺寸

(单位: mm)

##### ● PS50-30D □

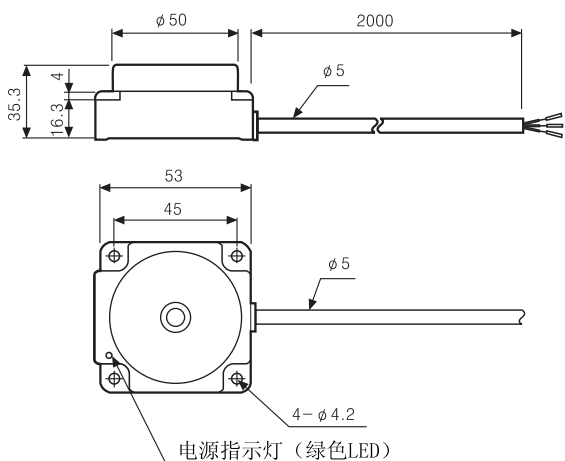

##### ● PS40-20D □

##### ● PSN40-20A □

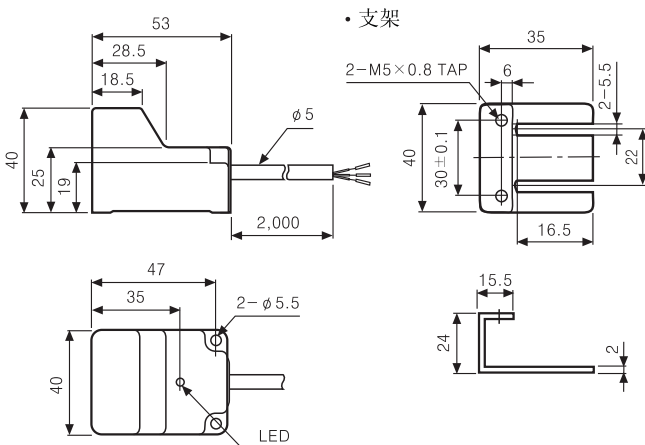

##### ● PFI25-8D □

##### ● PFI25-8A □

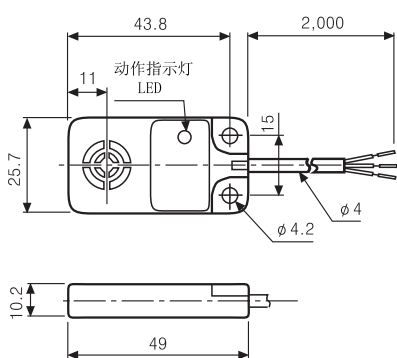

##### ● AS80-50D □

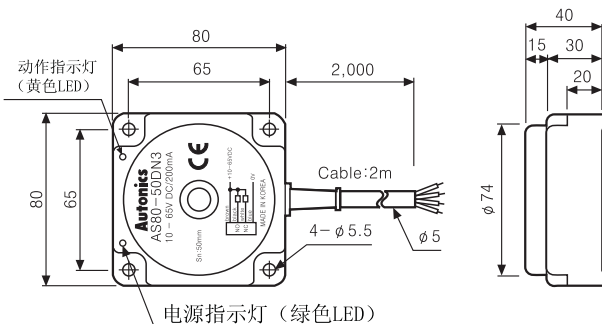

#### ■ 电容式尺寸

(单位: mm)

##### ● CR18-8D □

##### ● CR18-8A □

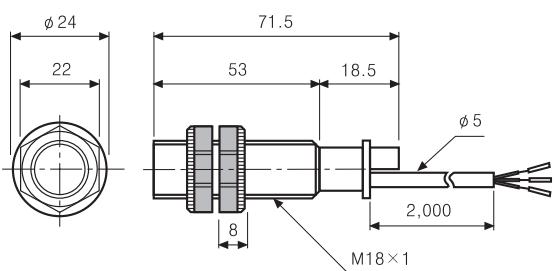

##### ● CR30-15D □

##### ● CR30-15A □

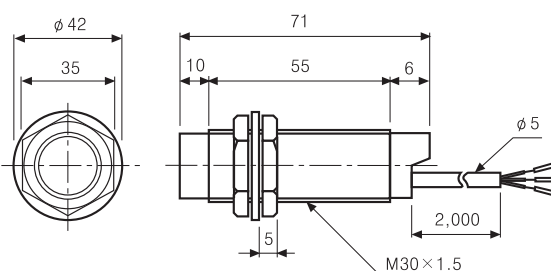

光电传感器

光纤传感器

门传感器  
区域传感器

接近开关

压力传感器

旋转编码器

配线/配件

温度控制器

SSR/  
功率控制器

计数器

计时器

电压/  
电流  
面板表

转速/  
线速  
脉冲表

显示单元

传感器  
控制器/  
开关电源

步进电机/  
驱动器/  
运动控制器





触摸屏

远程网络  
设备

## Selection Guide

### 接近开关

#### 中继盒/配件

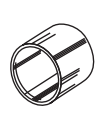
类 型	中继盒						配件 (另售)	
	直流2线式	直流3线式	直流2线式	直流3线式	直流2线式	直流3线式	防水盖	保护罩
型 号	PT4-2D	PT4-3DN PT4-3DP	PT6-2D	PT6-3DN PT6-3DP	PT8-2D	PT8-3DN PT8-3DP	P96-M12-1	—
外 形 尺 寸	 [W50×H27.5×L73mm]		 [W50×H27.5×L98mm]		 [W50×H27.5×L123mm]			
插 座 数	4		6		8		适用型号	
电 源 电 压	12-24VDC						●PT4-□□□ ●PT6-□□□ ●PT8-□□□	
防 护 等 级	IP66 (IEC 规格) ※IP67: 在使用防水盖的情况下							

#### 外形尺寸图

◎ 中继盒

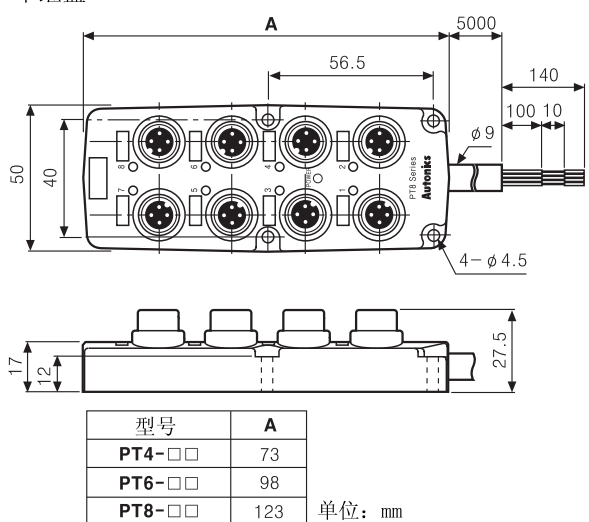

#### 面板安装连接头

◎ 面板安装连接头 (非齐平)

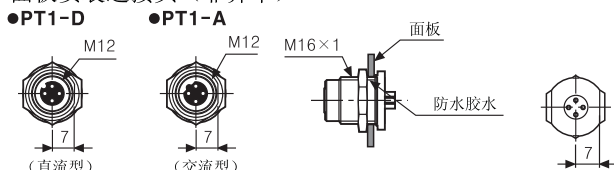

◎ 面板安装连接头 (齐平)

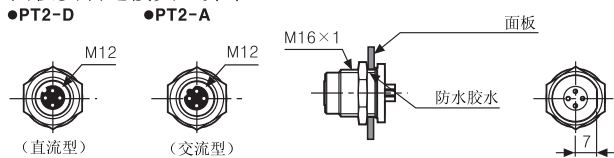

◎ 面板开孔尺寸

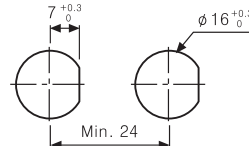

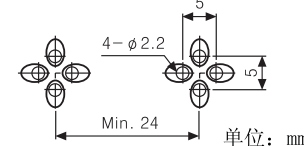

◎ PCB 尺寸

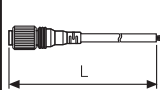
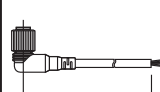

#### 连接电缆

◎ 出线式

外 形 尺 寸	型 号		电 缆	电 缆 长 度 (L)	电 缆 绝 缘 皮	
	直 流 型	交 流 型			材 料	电 缆 外 径 φ
	CID2-2(P)	CIA2-2(P)	2	2	PVC	φ 5
	CID2-2-1 ※	—	3			
	CID3-2(P)	—	4			
	CIDH4-3(P)	—	3	5		
	CID2-5(P)	CIA2-5(P)	2			
	CID2-5-1 ※	—	3			
	CID3-5	—	3	2		
	CIDH4-5(P)	—	4			
	CLD2-2(P)	CLA2-2(P)	2		3	
	CLD2-2-1 ※	—	3			
	CLD3-2(P)	—	4			
		CLDH4-3(P)	—	3	5	
CLD2-5(P)		CLA2-5(P)	2			
CLD2-5-1 ※		—	3			
CLD3-5		—	4			

◎ 接插式

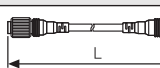
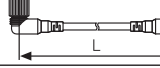
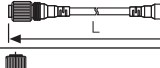
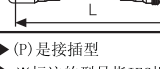
外 形 尺 寸	型 号		电 缆 长 度 (L)	电 缆 外 皮	
	直 流 型	交 流 型		材 料	电 缆 外 径 φ
	C1D4-2(P)	C1A4-2(P)	2	PVC	φ 5
	C1D4-5(P)	C1A4-5(P)	5		
	C2D4-2	C2A4-2	2		
	C2D4-5	C2A4-5	5		
	C3D4-2	C3A4-2	2		
	C3D4-5	C3A4-5	5		
	C4D4-2	C4A4-2	2		
	C4D4-5	C4A4-5	5		

▶ (P) 是接插型  
 ▶ ※标注的型号指IEC规格产品