ROYALOHM

SPECIFICATION FOR APPROVAL

CUSTOMER : 東盛
PRODUCT NAME : LEAD-FREE THICK FILM CHIP RESISTORS
PART NAME : CHIP SERIES $\pm 0.5\%, \pm 1\%, \pm 2\%, \pm 5\%$ & 0Ω

Approved	Checked	Prepared	File NO.	Edition	Date	Page
WILLIAM	APPLE	ELLIE	DS-01-01	1	2011.07.25	1/12

CONTENTS

INTRODUCTION	PAGE
1.0 SCOPE	4
2.0 RATINGS & DIMENSION	4
3.0 STRUCTURE.....	5
4.0 MARKING.....	5~7
5.0 POWER RATING.....	7
6.0 PERFORMANCE SPECIFICATION	7~8
7.0 EXPLANATION OF PART NO. SYSTEM	9~10
8.0 ORDERING PROCEDURE	10
9.0 STANDARD PACKING	11~12
10.0 STORAGE.....	12

Approved	Checked	Prepared	File NO.	Edition	Date	Page
WILLIAM	APPLE	ELLIE	DS-01-01	1	2011.07.25	2/12

FILE NAME: CHIP SERIES $\pm 0.5\%, \pm 1\%, \pm 2\%, \pm 5\% \& 0 \Omega$		DATE 2011.07.25	EDITION NO. 1		
AMENDMENT RECORD			SIGNATURE		
EDITION	PRESCRIPTION OF AMENDMENT	AMEND PAGE	AMEND DATE	AMENDED BY	CHECKED BY

Approved	Checked	Prepared	File NO.	Edition	Date	Page
WILLIAM	APPLE	ELLIE	DS-01-01	1	2011.07.25	3/12

1.0 SCOPE:

THIS SPECIFICATION FOR APPROVE RELATES TO THE LEAD-FREE THICK FILM CHIP RESISTORS MANUFACTURED BY ROYALOHM.

2.0 RATINGS & DIMENSION:

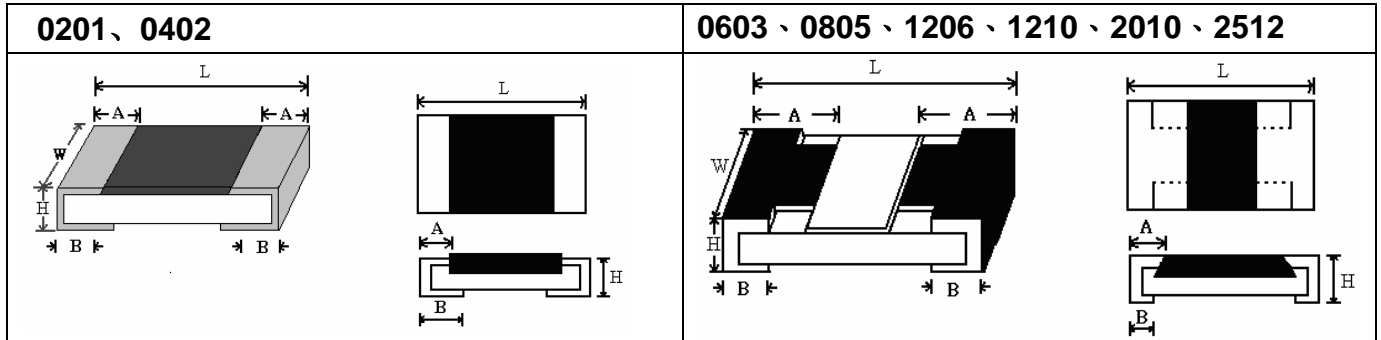

UNIT: MM

TYPE		0201	0402	0603	0805	1206	1210	2010	2512
POWER RATING AT 70°C		1/20W	1/16W	1/16W (1/10WS)	1/10W (1/8WS)	1/8W (1/4WS)	1/4W (1/2WSS)	1/2W (3/4WS)	1W
DIMENSION(MM)	L	0.60±0.03	1.0±0.10	1.60±0.10	2.00±0.15	3.10±0.15	3.10±0.10	5.00±0.10	6.35±0.10
	W	0.30±0.03	0.50±0.05	0.80 +0.15 -0.10	1.25 +0.15 -0.10	1.55 +0.15 -0.10	2.60 +0.15 -0.10	2.50 +0.15 -0.10	3.20 +0.15 -0.10
	H	0.23±0.03	0.35±0.05	0.45±0.10	0.55±0.10	0.55±0.10	0.55±0.10	0.55±0.10	0.55±0.10
	A	0.10±0.05	0.20±0.10	0.30±0.20	0.40±0.20	0.45±0.20	0.50±0.25	0.60±0.25	0.60±0.25
	B	0.15±0.05	0.25±0.10	0.30±0.20	0.40±0.20	0.45±0.20	0.50±0.20	0.50±0.20	0.50±0.20
RESISTANCE VALUE OF JUMPER		< 50mΩ	< 50mΩ	< 50mΩ	< 50mΩ	< 50mΩ	< 50mΩ	< 50mΩ	< 50mΩ
JUMPER RATED CURRENT		0.5A	1A	1A	2A	2A	2A	2A	2A
JUMPER RATED MAX OVERLOAD CURRENT		1A	2A	2A	5A	10A	10A	10A	10A
MAX WORKING VOLTAGE		25V	50V	50V	150V	200V	200V	200V	200V
MAX OVERLOAD VOLTAGE		50V	100V	100V	300V	400V	500V	500V	500V
DIELECTRIC WITHSTANDING VOLTAGE		--	100V	300V	500V	500V	500V	500V	500V
±0.5%		--	1Ω-10MΩ	1Ω-10MΩ	1Ω-10MΩ	1Ω-10MΩ	1Ω-10MΩ	1Ω-10MΩ	1Ω-10MΩ
±1%		1Ω-10MΩ	0.2Ω ---22MΩ	0.1Ω ---33MΩ	0.1Ω ---33MΩ	0.1Ω ---33MΩ	0.1Ω ---10MΩ	0.1Ω ---22MΩ	0.1Ω ---33MΩ
±2%		1Ω-10MΩ	0.2Ω ---22MΩ	0.1Ω ---33MΩ	0.1Ω ---33MΩ	0.1Ω ---33MΩ	0.1Ω ---22MΩ	0.1Ω ---22MΩ	0.1Ω ---33MΩ
±5%		1Ω-10MΩ	0.2Ω ---22MΩ	0.1Ω ---100MΩ	0.1Ω ---100MΩ	0.1Ω ---100MΩ	0.1Ω ---100MΩ	0.1Ω ---22MΩ	0.1Ω ---33MΩ
OPERATING TEMPERATURE		-55°C ~ +155°C							

Approved	Checked	Prepared	File NO.	Edition	Date	Page
WILLIAM	APPLE	ELLIE	DS-01-01	1	2011.07.25	4/12

3.0 STRUCTURE:

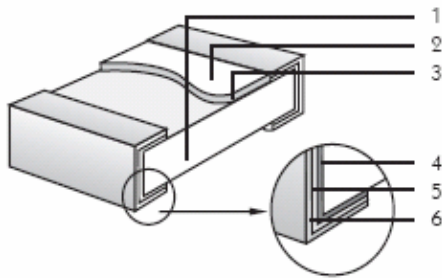

1. High purity alumina substrate
2. Protective covering
3. Resistance element
4. Termination (inner) Ni/Cr
5. Termination (between) Ni Barrier
6. Termination (outer) Sn

4.0 MARKING:

(1) FOR 0201 AND 0402 SIZE. DUE TO THE VERY SMALL SIZE OF THE RESISTOR'S BODY, THERE IS NO MARKING ON THE BODY.

EXAMPLE:

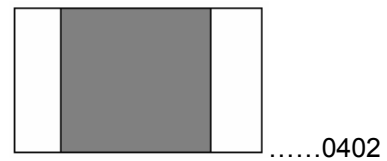
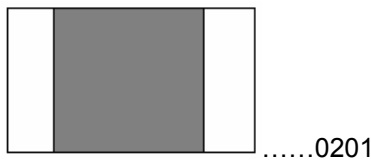

(2) $\pm 2\%$, $\pm 5\%$ TOLERANCE: THE FIRST TWO DIGITS ARE SIGNIFICANT FIGURES OF RESISTANCE AND THE THIRD DENOTES NUMBER OF ZEROS FOLLOWING

EXAMPLE:

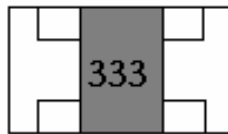

33000 \rightarrow 33K Ω

(3) $\pm 2\%$, $\pm 5\%$ TOLERANCE: BELOW 10 Ω SHOW AS FOLLOWING, READ ALPHABET "R" AS DECIMAL POINT.

EXAMPLE:

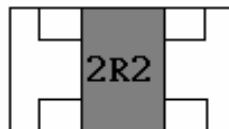

2R2 \rightarrow 2.2 Ω

(4) $\pm 0.5\%$, $\pm 1\%$ TOLERANCE: 4 DIGITS, FIRST THREE DIGITS ARE SIGNIFICANT; FORTH DIGIT IS NUMBER OF ZEROS. LETTER R IS DECIMAL POINT.

EXAMPLE:

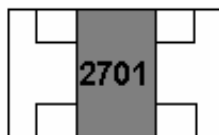

2701 \rightarrow 2.7K Ω

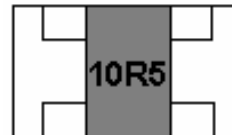

10R5 \rightarrow 10.5 Ω

(5) STANDARD E-96 SERIES VALUES ($\pm 0.5\%$, $\pm 1\%$ TOLERANCE) OF 0603 SIZE. DUE THE SMALL SIZE OF THE RESISTOR'S BODY, 3 DIGITS MARKING WILL BE USED TO INDICATE THE ACCURATE RESISTANCE VALUE BY USING THE FOLLOWING MULTIPLIER & RESISTANCE CODE.

MULTIPLIER CODE:

CODE	A	B	C	D	E	F	G	H	X	Y	Z
MULTIPLIER	10 ⁰	10 ¹	10 ²	10 ³	10 ⁴	10 ⁵	10 ⁶	10 ⁷	10 ⁻¹	10 ⁻²	10 ⁻³

Approved	Checked	Prepared	File NO.	Edition	Date	Page
WILLIAM	APPLE	ELLIE	DS-01-01	1	2011.07.25	5/12

CODING FORMULA

FIRST TWO DIGITS-----RESISTANCE CODE

THIRD DIGIT-----MULTIPLIER CODE

EXAMPLE: 1.96KΩ=196×10¹Ω-----29B

12.4Ω=124×10⁻¹Ω-----10X

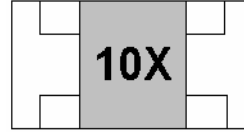

STANDARD E-96 VALUES AND 0603 RESISTANCE CODE

Ω VALUE	CODE	Ω VALUE	CODE	Ω VALUE	CODE	Ω VALUE	CODE
100	01	178	25	316	49	562	73
102	02	182	26	324	50	576	74
105	03	187	27	332	51	590	75
107	04	191	28	340	52	604	76
110	05	196	29	348	53	619	77
113	06	200	30	357	54	634	78
115	07	205	31	365	55	649	79
118	08	210	32	374	56	665	80
121	09	215	33	383	57	681	81
124	10	221	34	392	58	698	82
127	11	226	35	402	59	715	83
130	12	232	36	412	60	732	84
133	13	237	37	422	61	750	85
137	14	243	38	432	62	768	86
140	15	249	39	442	63	787	87
143	16	255	40	453	64	806	88
147	17	261	41	464	65	825	89
150	18	267	42	475	66	845	90
154	19	274	43	487	67	866	91
158	20	280	44	499	68	887	92
162	21	287	45	511	69	909	93
165	22	294	46	523	70	931	94
169	23	301	47	536	71	953	95
174	24	309	48	549	72	976	96

(6) STANDARD E-24 AND NOT BELONG TO E-96 SERIES VALUES(IN ±0.5%、±1% TOLERANCE) OF 0603 SIZE THE MARKING IS THE SAME AS 5% TOLERANCE BUT MARKING AS UNDERLINE

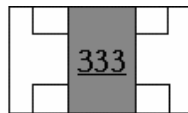

333=33000→33KΩ

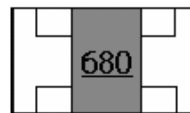

680→68Ω

(7) PRODUCT BELOW 1Ω, SHOW AS FOLLOWING, THE FIRST DIGIT IS “R” WHICH AS DECIMAL POINT.

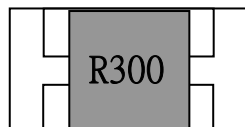

R300→0.3Ω

Approved	Checked	Prepared	File NO.	Edition	Date	Page
WILLIAM	APPLE	ELLIE	DS-01-01	1	2011.07.25	6/12

(8) 0Ω MARKING:

NORMALLY FOR 0201 AND 0402 SIZE, NO MARKING ON THE BODY:



NORMALLY, THE MAKING OF 0Ω 0603, 0Ω 0805, 0Ω 1206, 0Ω 1210, 0Ω 2010, 0Ω 2512 RESISTORS AS FOLLOWING



5.0 POWER RATING:

RESISTORS SHALL HAVE A POWER RATING BASED ON CONTINUOUS LOAD OPERATION AT AN AMBIENT TEMPERATURE FROM -50°C-70°C. FOR TEMPERATURE IN EXCESS OF 70°C, THE LOAD SHALL BE DERATE AS SHOWN IN FIGURE 1

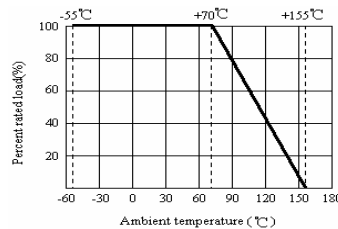

5.1 VOLTAGE RATING:

RESISTORS SHALL HAVE A RATED DIRECT-CURRENT (DC) CONTINUOUS WORKING VOLTAGE OR AN APPROXIMATE SINE-WAVE ROOT-MEAN-SQUARE (RMS) ALTERNATING-CURRENT (AC) CONTINUOUS WORKING VOLTAGE AT COMMERCIAL-LINE FREQUENCY AND WAVEFORM CORRESPONDING TO THE POWER RATING, AS DETERMINED FROM THE FOLLOWING FORMULA:

$$RCWV = \sqrt{P \times R}$$

WHERE: RCWV COMMERCIAL-LINE FREQUENCY AND WAVEFORM (VOLT.)

P = POWER RATING (WATT.) R = NOMINAL RESISTANCE (OHM)

IN NO CASE SHALL THE RATED DC OR RMS AC CONTINUOUS WORKING VOLTAGE BE GREATER THAN THE APPLICABLE MAXIMUM VALUE.

THE OVERLOAD VOLTAGE IS 2.5 TIMES RCWV OR MAX. OVERLOAD VOLTAGE WHICHEVER IS LESS.

6.0 PERFORMANCE SPECIFICATION:

CHARACTERISTIC	LIMITS	TEST METHOD (JIS-C-5201 & JIS-C-5202)
◎TEMPERATURE COEFFICIENT	0201: 1Ω ≤ R ≤ 10Ω: ±400PPM/°C >10Ω: ±200PPM/°C	4.8 NATURAL RESISTANCE CHANGES PER TEMP. DEGREE CENTIGRADE $\frac{R_2 - R_1}{R_1(T_2 - T_1)} \times 10^6$ (PPM/°C) R ₁ : RESISTANCE VALUE AT ROOM TEMP. (T ₁) R ₂ : RESISTANCE VALUE AT ROOM TEMP. +100°C (T ₂) TEST PATTERN: ROOM TEMP. (T ₁), ROOM TEMP. +100°C (T ₂)
	0402~2512 : <1Ω ≤ ±800PPM/°C 1Ω ≤ R ≤ 10Ω ≤ ±400PPM/°C 10Ω < R ≤ 100Ω ≤ ±200PPM/°C 100Ω ≤ R < 10MΩ ≤ ±100PPM/°C 10MΩ ≤ R < 100MΩ ≤ ±200PPM/°C	

Approved	Checked	Prepared	File NO.	Edition	Date	Page
WILLIAM	APPLE	ELLIE	DS-01-01	1	2011.07.25	7/12

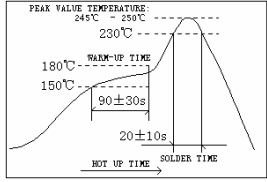
◎ *SHORT-TIME OVERLOAD	±0.5%,±1%	±(1%+0.1Ω) MAX.	4.13 PERMANENT RESISTANCE CHANGE AFTER THE APPLICATION OF A POTENTIAL OF 2.5 TIMES RCWV OR MAX. OVERLOAD VOLTAGE WHICHEVER LESS FOR 5 SECONDS..															
	±2%,±5%	±(2%+0.1Ω) MAX.																
	* ΔR<50MΩ		APPLY MAX OVERLOAD CURRENT FOR 0Ω															
* DIELECTRIC WITHSTANDING VOLTAGE	NO EVIDENCE OF FLASHOVER MECHANICAL DAMAGE, ARCING OR INSULATION BREAKS DOWN.		4.7 RESISTORS SHALL BE CLAMPED IN THE TROUGH OF A 90°C METALLIC V-BLOCK AND SHALL BE TESTED AT AC POTENTIAL RESPECTIVELY SPECIFIED IN THE GIVEN LIST OF EACH PRODUCT TYPE FOR 60-70 SECONDS.															
◎ *SOLDERABILITY	95% COVERAGE MIN.		WAVE SOLDER: TEST TEMPERATURE OF SOLDER: 245°C±3°C DIPPING TIME IN SOLDER: 2-3 SECONDS.															
	GO UP TIN RATE BIGGER THAN HALF OF END POLE		REFLOW: 															
◎ TEMPERATURE CYCLING	±0.5%,±1%	±(0.5%+0.05 Ω)MAX	4.19RESISTANCE CHANGE AFTER CONTINUOUS FIVE CYCLES FOR DUTY CYCLE SPECIFIED BELOW: <table border="1" data-bbox="817 929 1433 1120"> <thead> <tr> <th>STEP</th> <th>TEMPERATURE</th> <th>TIME</th> </tr> </thead> <tbody> <tr> <td>1</td> <td>-55°C±3°C</td> <td>30 MINS</td> </tr> <tr> <td>2</td> <td>ROOM TEMP.</td> <td>10 --- 15 MINS</td> </tr> <tr> <td>3</td> <td>+155°C±2°C</td> <td>30 MINS</td> </tr> <tr> <td>4</td> <td>ROOM TEMP.</td> <td>10 --- 15 MINS</td> </tr> </tbody> </table>	STEP	TEMPERATURE	TIME	1	-55°C±3°C	30 MINS	2	ROOM TEMP.	10 --- 15 MINS	3	+155°C±2°C	30 MINS	4	ROOM TEMP.	10 --- 15 MINS
	STEP	TEMPERATURE		TIME														
1	-55°C±3°C	30 MINS																
2	ROOM TEMP.	10 --- 15 MINS																
3	+155°C±2°C	30 MINS																
4	ROOM TEMP.	10 --- 15 MINS																
±2%,±5%	±(1.0%+0.05 Ω) MAX																	
◎ SOLDERING HEAT	RESISTANCE CHANGE RATE IS: ±(1%+0.05Ω) MAX		4.18 DIP THE RESISTOR INTO A SOLDER BATH HAVING A TEMPERATURE OF 260°C±5°C AND HOLD IT FOR 10±1 SECONDS.															
TERMINAL BENDING	±(1%+0.05Ω) MAX		4.33 TWIST OF TEST BOARD: Y/X = 3/90 MM FOR 60SECONDS															
* INSULATION RESISTANCE	1,000 MΩ OR MORE		4.6 THE MEASURING VOLTAGE SHALL BE ,MEASURED WITH A DIRECT VOLTAGE OF (100±15)V OR A VOLTAGE EQUAL TO THE DIELECTRIC WITHSTANDING VOLTAGE., AND APPLY FOR 1MIN															
◎ HUMIDITY (STEADY STATE)	±0.5%,±1%	±(0.5%+0.1Ω) MAX.	4.24TEMPORARY RESISTANCE CHANGE AFTER 240 HOURS EXPOSURE IN A HUMIDITY TEST CHAMBER CONTROLLED AT 40±2°C AND 90-95% RELATIVE HUMIDITY,															
	±2%,±5%	±(3.0%+0.1Ω) MAX.																
◎ *LOAD LIFE IN HUMIDITY	±0.5%,±1%	±(1%+0.1Ω)MAX.	7.9 RESISTANCE CHANGE AFTER 1,000 HOURS (1.5 HOURS "ON",0.5 HOUR "OFF") AT RCWV IN A HUMIDITY CHAMBER CONTROLLED AT 40°C±2°C AND 90 TO 95% RELATIVE HUMIDITY.															
	±2%,±5%	±(3%+0.1Ω)MAX.																
	* ΔR<50MΩ		APPLY TO RATED CURRENT FOR 0Ω															
◎ *LOAD LIFE	±0.5%,±1%	±(1%+0.1Ω)MAX.	4.25.1 PERMANENT RESISTANCE CHANGE AFTER 1,000 HOURS OPERATING AT RCWV WITH DUTY CYCLE 1.5 HOURS "ON", 0.5 HOUR "OFF" AT 70°C±2°C AMBIENT.															
	±2%,±5%	±(3%+0.1Ω)MAX																
	* ΔR<50MΩ		APPLY TO RATED CURRENT FOR 0Ω															
THE RESISTORS OF 0Ω ONLY CAN DO THE CHARACTERISTIC NOTED OF * THE RESISTORS OF 0201 ONLY CAN DO THE CHARACTERISTIC NOTED OF ◎																		

Approved	Checked	Prepared	File NO.	Edition	Date	Page
WILLIAM	APPLE	ELLIE	DS-01-01	1	2011.07.25	8/12

7.0 EXPLANATION OF PART NO. SYSTEM:

THE STANDARD PART NO. INCLUDES 14 DIGITS WITH THE FOLLOWING EXPLANATION:

7.1 1TH~4TH DIGITS

THIS IS TO INDICATE THE CHIP RESISTOR.

EXAMPLE:

0201, 0402,0603,0805,1206,1210,2010,2512

7.2 5TH~6TH DIGITS:

7.2.1 THIS IS TO INDICATE THE WATTAGE OR POWER RATING. TO DIETING THE SIZE AND THE NUMBERS,

THE FOLLOWING CODES ARE USED; AND PLEASE REFER TO THE FOLLOWING CHART FOR DETAIL:

W=NORMAL SIZE; S=SMALL SIZE; U=EXTRA SMALL SIZE; “1” ~ “G” TO DENOTES “1” ~ “16” AS HEXADECIMAL:

1/16W~1W:

WATTAGE	3/4W	1/2	1/3	1/4	1/8	1/10	1/16	1
NORMAL SIZE	07	W2	W3	W4	W8	WA	WG	1W
SMALL SIZE	07	S2	S3	S4	S8	SA	SG	1S
ULTRA SMALL SIZE	/	U2	U3	U4	U8	UA	UG	1U

7.2.2 FOR POWER RATING LESS THAN 1 WATT, THE 5TH DIGIT WILL BE THE LETTERS W OR S TO REPRESENT THE SIZE REQUIRED & THE 6TH DIGIT WILL BE A NUMBER OR A LETTER CODE.

EXAMPLE:

WA=1/10W; S4=1/4W-S

7.3 THE 7TH DIGIT IS TO DENOTE THE RESISTANCE TOLERANCE. THE FOLLOWING LETTER CODE IS TO BE USED FOR INDICATING THE STANDARD RESISTANCE TOLERANCE.

D=±0.5% F=±1% G=±2% J=±5% K= ±10%

7.4 THE 8TH TO 11TH DIGITS IS TO DENOTE THE RESISTANCE VALUE.

7.4.1 FOR THE STANDARD RESISTANCE VALUES OF E-24 SERIES, THE 8TH DIGIT IS “0” ,THE 9TH & 10TH DIGITS ARE TO DENOTE THE SIGNIFICANT FIGURES OF THE RESISTANCE AND THE 11TH DIGIT IS THE NUMBER ZEROS FOLLOWING;

FOR THE STANDARD RESISTANCE VALUES OF E-96 SERIES, THE 8TH DIGIT TO THE 10TH DIGITS IS TO DENOTE THE SIGNIFICANT FIGURES OF THE RESISTANCE AND THE 11TH DIGIT IS THE ZEROS FOLLOWING.

7.4.2 THE FOLLOWING NUMBER S AND THE LETTER CODES ARE TO BE USED TO INDICATE THE NUMBER OF ZEROS IN THE 11TH DIGIT:

0=10⁰ 1=10¹ 2=10² 3=10³ 4=10⁴ 5=10⁵
 6=10⁶ J=10⁻¹ K=10⁻² L=10⁻³ M=10⁻⁴

Approved	Checked	Prepared	File NO.	Edition	Date	Page
WILLIAM	APPLE	ELLIE	DS-01-01	1	2011.07.25	9/12

7.4.3 THE 12TH, 13TH & 14TH DIGITS.

THE 12TH DIGIT IS TO DENOTE THE PACKAGING TYPE WITH THE FOLLOWING CODES:

C=BULK IN (CHIP PRODUCT)

T=TAPE/REEL

7.4.4 THE 13TH DIGIT IS NORMALLY TO INDICATE THE PACKING QUANTITY OF TAPE/BOX & TAPE/REEL PACKAGING TYPES. THE FOLLOWING LETTER CODE IS TO BE USED FOR SOME PACKING QUANTITIES:

1=1000PCS

2=2000PCS

3=3000PCS

4=4000PCS

5=5000PCS

C=10000PCS

D=20000PCS

E=15000PCS

CHIP PRODUCT: BD=B/B-20000PCS

TC=T/R-10000PCS

7.4.5 FOR SOME ITEMS, THE 14TH DIGIT ALONE CAN USE TO DENOTE SPECIAL FEATURES OF ADDITIONAL INFORMATION WITH THE FOLLOWING CODES:

E=FOR “ENVIRONMENTAL PROTECTION, LEAD FREE TYPE” OF CHIP, CHIP ARRAY OR CHIP NETWORK RESISTORS.

8.0 ORDERING PROCEDURE: (EXAMPLE: 0805 S 8 J 0 1 0 3 T 5 E)

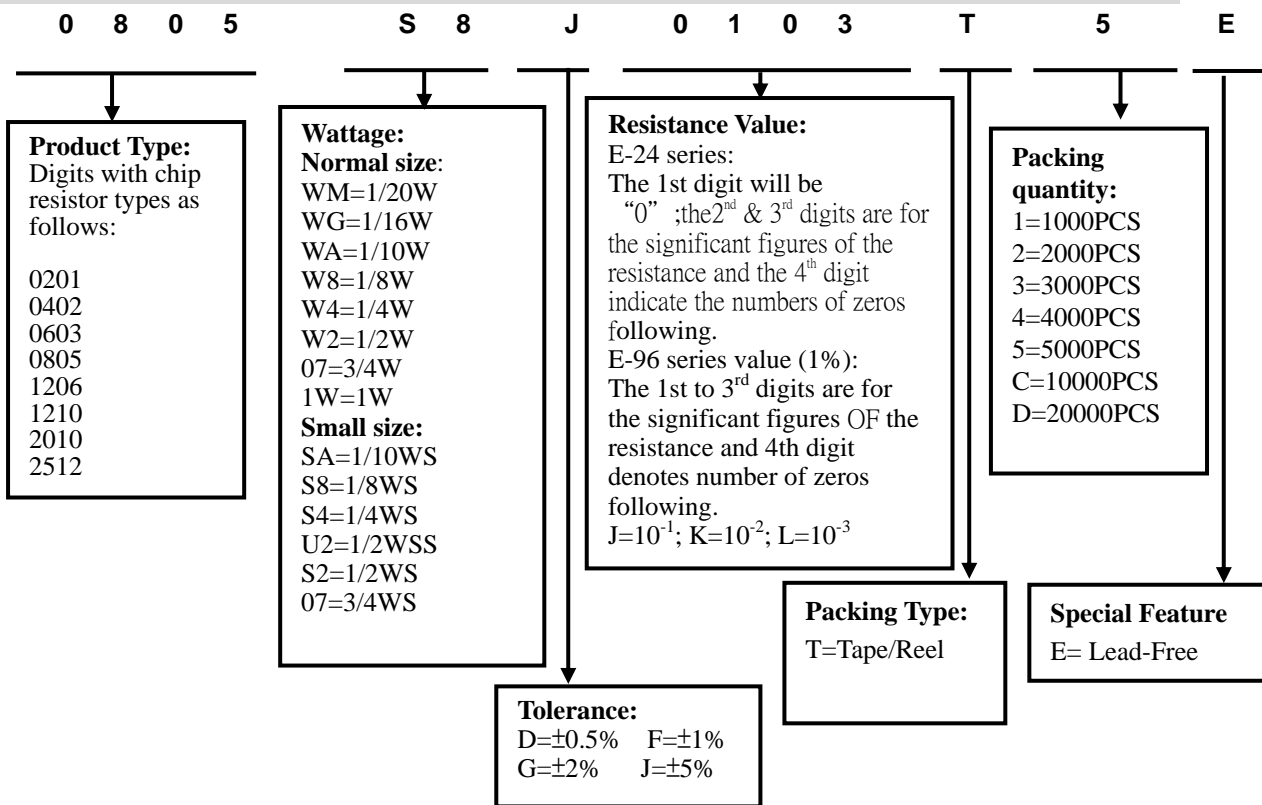

Approved	Checked	Prepared	File NO.	Edition	Date	Page
WILLIAM	APPLE	ELLIE	DS-01-01	1	2011.07.25	10/12

9.0 PACKAGING:

9.1 TAPPING DIMENSION:

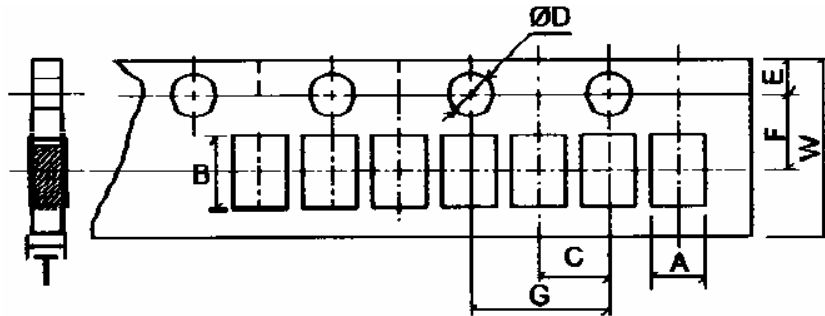

UNIT: MM

TYPE	A	B	C±0.05	ΦD ^{+0.1} -0	E±0.1	F±0.05	G±0.1	W±0.2	T±0.1
0201	0.4±0.05	0.7±0.05	2.0	1.5	1.75	3.5	4.0	8.0	0.42
0402	0.65±0.2	1.15±0.2	2.0	1.5	1.75	3.5	4.0	8.0	0.45

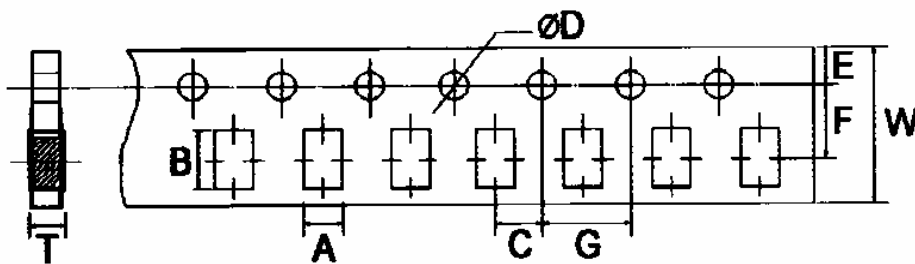

UNIT: MM

TYPE	A ±0.2	B ±0.2	C±0.05	ΦD ^{+0.1} -0	E±0.1	F±0.05	G±0.1	W±0.2	T±0.1
0603	1.10	1.90	2.0	1.5	1.75	3.5	4.0	8.0	0.67
0805	1.65	2.40	2.0	1.5	1.75	3.5	4.0	8.0	0.81
1206	2.00	3.60	2.0	1.5	1.75	3.5	4.0	8.0	0.81
1210	2.80	3.50	2.0	1.5	1.75	3.5	4.0	8.0	0.75
2010	2.80	5.40	2.0	1.5	1.75	5.5	4.0	12.0	0.75

Approved	Checked	Prepared	File NO.	Edition	Date	Page
WILLIAM	APPLE	ELLIE	DS-01-01	1	2011.07.25	11/12

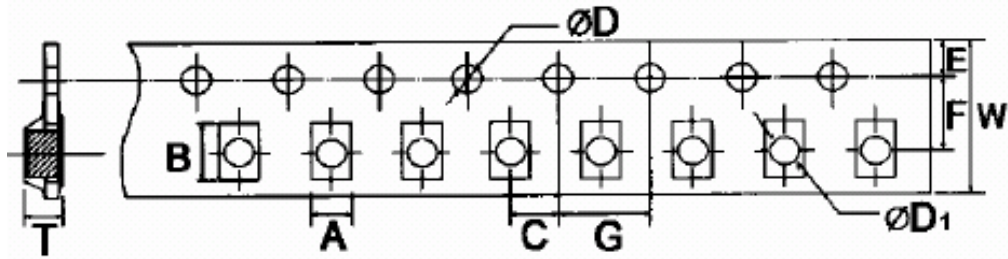

UNIT: MM

TYPE	A±0.2	B±0.2	C±0.05	+ 0.1 φD - 0	+0.25 φD1 -0	E±0.1	F±0.05	G±0.1	W±0.2	T±0.1
2512	3.5	6.7	2.0	1.5	1.5	1.75	5.5	4.0	12	1.0

9.2 DIMENSION:

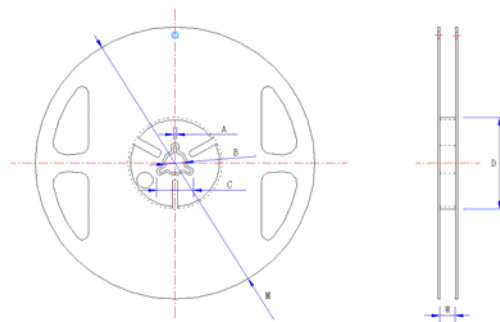

UNIT: MM

TYPE	TAPING	QTY/REEL	A±0.5	B±0.5	C±0.5	D±1	M±2	W±1
0201	PAPER	10,000PCS	2.0	13.0	21.0	60.0	178	10
0402	PAPER	10,000PCS	2.0	13.0	21.0	60.0	178	10
0603	PAPER	5,000PCS	2.0	13.0	21.0	60.0	178	10
0805	PAPER	5,000PCS	2.0	13.0	21.0	60.0	178	10
1206	PAPER	5,000PCS	2.0	13.0	21.0	60.0	178	10
1210	PAPER	5,000PCS	2.0	13.0	21.0	60.0	178	10
2010	PAPER OR EMBOSSED	4,000PCS	2.0	13.0	21.0	60.0	178	13.8
2512	EMBOSSED	4,000PCS	2.0	13.0	21.0	60.0	178	13.8

10.0 STORAGE:

THE PRODUCTS SHOULD BE PLACED IN THE DRY AND VENTILATION WITH 15~35°C AND LOWER THAN 25~75%RH,AND PREVENT IT FROM PRESSING AND HUMIDITY. THE GUARANTEED PERIOD OF PRODUCT PERFORMANCE IS WITHIN ONE YEAR FROM SHIPMENT BY THE COMPANY, PROVIDED THAT THE ABOVE-MENTIONED STORAGE CONDITIONS HAVE BEEN SATISFIED.

Approved	Checked	Prepared	File NO.	Edition	Date	Page
WILLIAM	APPLE	ELLIE	DS-01-01	1	2011.07.25	12/12