

# Linear Single Cell Li-Ion Battery Charger with Auto Power Path Management

## General Description

The RT9519B is an integrated single cell Li-ion battery charger with Auto Power Path Management (APPM). No external MOSFETs are required. The RT9519B enters sleep mode when power is removed. Charging tasks are optimized by using a control algorithm to vary the charge rate, including pre-charge mode, fast charge mode and constant voltage mode. For the RT9519B, the charge current can also be programmed with an external resistor and modified with an external GPIO. The scope that the battery regulation voltage can be modified with an external GPIO depends on the battery temperature. The internal thermal feedback circuitry regulates the die temperature to optimize the charge rate for all ambient temperatures. The charging task will always be terminated in constant voltage mode when the charging current reduces to the termination current of  $10\% \times I_{CHG\_FAST}$ . Other features include under voltage protection and over voltage protection for VIN the supply.

## Ordering Information

RT9519B□□

- Package Type  
QW : WQFN-20L 3x3 (W-Type)
- Lead Plating System  
G : Green (Halogen Free and Pb Free)

Note :

Richtek products are :

- ▶ RoHS compliant and compatible with the current requirements of IPC/JEDEC J-STD-020.
- ▶ Suitable for use in SnPb or Pb-free soldering processes.

## Marking Information

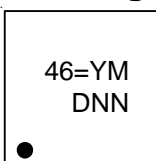

46= : Product Code  
YMDNN : Date Code

## Features

- 28V Maximum Rating for VIN Power
- Selectable Power Current Limit (0.1A / 0.5A / 1.5A)
- Integrated Power MOSFETs
- Auto Power Path Management (APPM)
- Battery Charging Current Control
- Battery Regulation Voltage Control
- Programmable Charging Current and Safe Charge Timer
- Under Voltage Protection, Over Voltage Protection
- Power Good and Charge Status Indicator
- Optimized Charge Rate via Thermal Feedback
- Thin 20-Lead WQFN Package
- RoHS Compliant and Halogen Free

## Applications

- Digital Cameras
- PDAs and Smart Phones
- Portable Instruments

## Pin Configurations

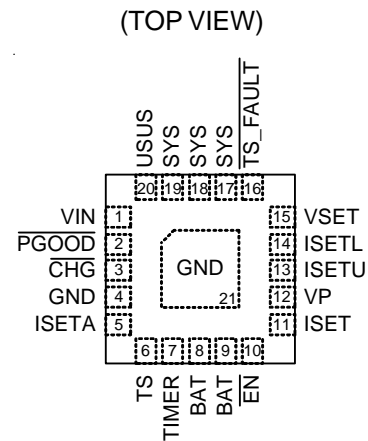

WQFN-20L 3x3



**Functional Pin Description**

Pin No.	Pin Name	Pin Function
1	VIN	Supply Voltage Input.
2	$\overline{\text{PGOOD}}$	Power Good Status Output. Open-drain output.
3	$\overline{\text{CHG}}$	Charger Status Output. Open-drain output.
4, 21 (Exposed Pad)	GND	Ground. The exposed pad must be soldered to a large PCB and connected to GND for maximum power dissipation.
5	ISETA	Charge Current Set Input. Connect a resistor ( $R_{\text{ISETA}}$ ) between ISETA and GND.
6	TS	Temperature Sense Input. The TS pin connects to a battery's thermistor to determine if the battery is too hot or too cold to charge. If the battery's temperature is out of range, charging is paused until it re-enters the valid range. TS also detects whether the battery (with NTC) is present or not.
7	TIMER	Safe Charge Timer Setting.
8,9	BAT	Battery Charge Current Output.
10	$\overline{\text{EN}}$	Charge Enable. Active Low input. 200k $\Omega$ pull low.
11	ISET	Half Charge Current Set Input. Control by external GPIO, L = $I_{\text{CHG1}} / 2$ , H = $I_{\text{CHG1}}$ , 200k $\Omega$ pull low.
12	VP	This pin must be provided a regulated voltage from 2.95V to 3.6V by external power.
13	ISETU	VIN Current Limit Control Input. When ISETL = L, L = 100mA, H = 500mA, 200k $\Omega$ pull low.
14	ISETL	VIN Current Limit Control Input. L : see ISETU, H = 1.5A, 200k $\Omega$ pull low.
15	VSET	Battery Regulation Set Input. Control by external GPIO. L = 4.05V, H = 4.2V, 200k $\Omega$ pull low.
16	$\overline{\text{TS\_FAULT}}$	TS Fault Status Output. Open-drain Output. If TS is of fault ( <u>too cold, too hot</u> ) or VP triggers UVLO, $\overline{\text{TS\_FAULT}} = \text{L}$ . If TS and VP are normal, $\overline{\text{TS\_FAULT}} = \text{H}$ .
17, 18, 19	SYS	System Connect Pin. Connect this pin to System with a minimum 10 $\mu\text{F}$ ceramic capacitor to GND.
20	USUS	VIN Suspend Control Input. H = Suspend, L = No suspend. 200k $\Omega$ pull low.

## Absolute Maximum Ratings (Note 1)

- Supply Voltage,  $V_{IN}$  ----- -0.3V to 28V
- CHG, PGOOD ----- -0.3V to 28V
- Other Pins ----- -0.3V to 6V
- CHG, PGOOD Continuous Current ----- 20mA
- BAT Continuous Current (total in two pins) (Note 2) ----- 2.5A
- Power Dissipation,  $P_D$  @  $T_A = 25^\circ\text{C}$   
 WQFN-20L 3x3 ----- 1.471W
- Package Thermal Resistance (Note 3)  
 WQFN-20L 3x3,  $\theta_{JA}$  ----- 68°C/W  
 WQFN-20L 3x3,  $\theta_{JC}$  ----- 7.5°C/W
- Lead Temperature (Soldering, 10 sec.) ----- 260°C
- Junction Temperature ----- 150°C
- Storage Temperature Range ----- -65°C to 150°C
- ESD Susceptibility (Note 4)  
 HBM (Human Body Mode) ----- 2kV  
 MM (Machine Mode) ----- 200V

## Recommended Operating Conditions (Note 5)

- Supply Input Voltage Range,  $V_{IN}$  (ISETL = H) ----- 4.4V to 6V
- Supply Input Voltage Range,  $V_{IN}$  (ISETL = L) ----- 4.5V to 6V
- Junction Temperature Range ----- -40°C to 125°C
- Ambient Temperature Range ----- -40°C to 85°C

## Electrical Characteristics

( $V_{IN} = 5V$ ,  $V_{BAT} = 4V$ ,  $T_A = 25^\circ\text{C}$ , unless otherwise specified)

Parameter	Symbol	Test Conditions	Min	Typ	Max	Unit
<b>Supply Input</b>						
VIN Under Voltage Lockout Threshold	$V_{UVLO}$	$V_{IN} = 0V$ to 4V	3.1	3.3	3.5	V
VIN Under Voltage Lockout Hysteresis	$\Delta V_{UVLO}$	$V_{IN} = 4V$ to 0V	--	240	--	mV
VIN Supply Current	$I_{SUPPLY}$	$I_{SYS} = I_{BAT} = 0mA$ , $\overline{EN} = L$ ( $V_{BAT} > V_{REGx}$ )	--	1	2	mA
		$I_{SYS} = I_{BAT} = 0mA$ , $\overline{EN} = H$ ( $V_{BAT} > V_{REGx}$ )	--	0.8	1.5	
VIN Suspend Current	$I_{USUS}$	$V_{IN} = 5V$ , USUS = H	--	195	300	$\mu A$
VBAT Sleep Leakage Current	$I_{SLEEP}$	$V_{BAT} > V_{IN}$ , ( $V_{IN} = 0V$ )	--	5	15	$\mu A$
VIN-BAT VOS Rising	$V_{OS\_H}$		--	200	300	mV
VIN-BAT VOS Falling	$V_{OS\_L}$		10	50	--	mV
<b>Voltage Regulation</b>						
System Regulation Voltage	$V_{SYS}$	$I_{SYS} = 800mA$	4.3	4.4	4.5	V
Battery Regulation Voltage	$V_{REG1}$	0 to 85°C, Loading = 20mA, When VSET = H	4.16	4.2	4.23	V
Battery Regulation Voltage	$V_{REG2}$	0 to 85°C, Loading = 20mA, When VSET = L	4.01	4.05	4.08	V
APPM Regulation Voltage	$\Delta V_{APPM}$	$V_{SYS} - \Delta V_{APPM}$	120	200	280	mV

*To be continued*

Parameter	Symbol	Test Conditions	Min	Typ	Max	Unit
DPM Regulation Voltage	V <sub>DPM</sub>	ISETL = L	4.3	4.4	4.5	V
VIN to VSYS MOSFET Ron	R <sub>DS(ON)</sub>	I <sub>VIN</sub> = 1000mA	--	0.2	0.35	Ω
BAT to VSYS MOSFET Ron	R <sub>DS(ON)</sub>	V <sub>BAT</sub> = 4.2V, I <sub>SYS</sub> = 1A	--	0.05	0.1	Ω
Re-Charge Threshold	ΔV <sub>REGCHG</sub>	Battery Regulation – Recharge level	60	100	140	mV
<b>Current Regulation</b>						
ISETA Set Voltage (Fast Charge Phase)	V <sub>ISETA</sub>	V <sub>BAT</sub> = 4V, R <sub>ISETA</sub> = 1kΩ	--	2	--	V
Charge Current Setting Range	I <sub>CHG</sub>		100	--	1200	mA
Charge Current Accuracy1	I <sub>CHG1</sub>	V <sub>BAT</sub> = 4V, R <sub>ISETA</sub> = 1kΩ ISET = H	570	600	630	mA
Charge Current Accuracy2	I <sub>CHG2</sub>	V <sub>BAT</sub> = 3.8V, R <sub>ISETA</sub> = 1kΩ ISET = L	285	300	315	mA
VIN Current Limit	I <sub>VIN</sub>	ISETL = H (1.5A Mode)	1.2	1.5	1.8	A
		ISETL = L, ISETU = H (500mA mode)	450	475	500	mA
		ISETL = L, ISETU = L (100mA Mode)	90	95	100	mA
<b>Pre-charge</b>						
BAT Pre-Charge Threshold	V <sub>PRECH</sub>	BAT Falling	2.7	2.8	2.9	V
BAT Pre-Charge Threshold Hysteresis	ΔV <sub>PRECH</sub>		--	200	--	mV
Pre-Charge Current	I <sub>CHG_PRE</sub>	V <sub>BAT</sub> = 2V	5	10	15	%
<b>Charge Termination Detection</b>						
Termination Current Ratio to Fast Charge (Except USB 100 Mode)	I <sub>TERM</sub>	ISETL = L, ISETU = H ISETL = H, ISETU = X	5	10	15	%
Termination Current Ratio to Fast Charge (USB100 Mode)	I <sub>TERM2</sub>	ISETL = L, ISETU = L	--	3.3	--	%
<b>Login Input/Output</b>						
CHG Pull Down Voltage	V <sub>CHG</sub>	I <sub>CHG</sub> = 5mA	--	200	--	mV
PGOOD Pull Down Voltage	V <sub>PGOOD</sub>	I <sub>PGOOD</sub> = 5mA	--	200	--	mV
TS_FAULT Pull Down Voltage	V <sub>TS_FAULT</sub>	I <sub>TS_FAULT</sub> = 5mA	--	200	--	mV
EN, ISETL, USUS, ISETU, VSET, ISET Threshold Voltage	Logic-High	V <sub>IH</sub>	1.5	--	--	V
	Logic-Low	V <sub>IL</sub>	--	--	0.4	
<b>Protection</b>						
Thermal Regulation	T <sub>REG</sub>		--	125	--	°C
Thermal Shutdown Temperature	T <sub>SD</sub>		--	155	--	°C
Thermal Shutdown Hysteresis	ΔT <sub>SD</sub>		--	20	--	°C
Over Voltage Protection	V <sub>OVP</sub>	V <sub>VIN</sub> Rising	6.25	6.5	6.75	V
Over Voltage Protection Hysteresis	ΔV <sub>OVP</sub>	V <sub>VIN</sub> = 7V to 5V, V <sub>OVP</sub> – ΔV <sub>OVP</sub>	--	100	--	mV
Output Short Circuit Detection Threshold	V <sub>SHORT</sub>	V <sub>BAT</sub> – V <sub>VSYS</sub>	--	300	--	mV

*To be continued*

Parameter	Symbol	Test Conditions	Min	Typ	Max	Unit
<b>Time</b>						
Pre-Charge Fault Time	t <sub>PCHG</sub>	C <sub>TIMER</sub> = 1μF (1/8 x t <sub>FCHG</sub> )	1440	1800	2160	s
Fast charge Fault Time	t <sub>FCHG</sub>	C <sub>TIMER</sub> = 1μF	11520	14400	17280	s
$\overline{\text{PGOOD}}$ Deglitch Time	$\overline{\text{tPGOOD}}$	Time measured from VIN : 0→5V 1μs rise-time to $\overline{\text{PGOOD}} = \text{L}$	--	1	--	s
Input Over Voltage Blanking Time	t <sub>OVP</sub>		--	50	--	μs
Pre-Charge to Fast-Charge Deglitch Time	t <sub>PF</sub>		--	25	--	ms
Fast-Charge to Pre-Charge Deglitch Time	t <sub>FP</sub>		--	25	--	ms
Termination Deglitch Time	t <sub>TERMI</sub>		--	25	--	ms
Recharge Deglitch Time	t <sub>RECHG</sub>		--	100	--	ms
Input Power Loss to SYS LDO Turn-Off Delay Time	t <sub>NO_IN</sub>		--	25	--	ms
Pack Temperature Fault Detection Deglitch Time	t <sub>TS</sub>		--	25	--	ms
Short Circuit Deglitch Time	t <sub>SHORT</sub>		--	250	--	μs
Short Circuit Recovery Time	t <sub>SHORT-R</sub>		--	64	--	ms
<b>Other</b>						
VP (External used only)	V <sub>VP</sub>		2.95	--	3.6	V
VP Under Voltage Lockout Threshold		Falling Threshold	--	0.8	--	V
TS Battery Detect Threshold	V <sub>TS</sub>		2.75	2.85	2.95	V
<b>NTC</b>						
Low Temperature Trip Point	V <sub>COLD</sub>	Rising Threshold	73	74	75	% of VP
Low Temperature Trip point Hysteresis	ΔV <sub>COLD</sub>		--	1	--	% of VP
High Temperature Trip Point	V <sub>HOT</sub>	Falling Threshold	27	28	29	% of VP
High Temperature Trip Point Hysteresis	ΔV <sub>HOT</sub>		--	1	--	% of VP

**Note 1.** Stresses listed as the above "Absolute Maximum Ratings" may cause permanent damage to the device. These are for stress ratings. Functional operation of the device at these or any other conditions beyond those indicated in the operational sections of the specifications is not implied. Exposure to absolute maximum rating conditions for extended periods may remain possibility to affect device reliability.

**Note 2.** Guraranteed by design.

**Note 3.** θ<sub>JA</sub> is measured in natural convection at T<sub>A</sub> = 25°C on a high effective thermal conductivity four-layer test board of JEDEC 51-7 thermal measurement standard. The measurement case position of θ<sub>JC</sub> is on the exposed pad of the package.

**Note 4.** Devices are ESD sensitive. Handling precaution is recommended.

**Note 5.** The device is not guaranteed to function outside its operating conditions.

Typical Operating Characteristics

Charger On/Off Control from  $\overline{EN}$

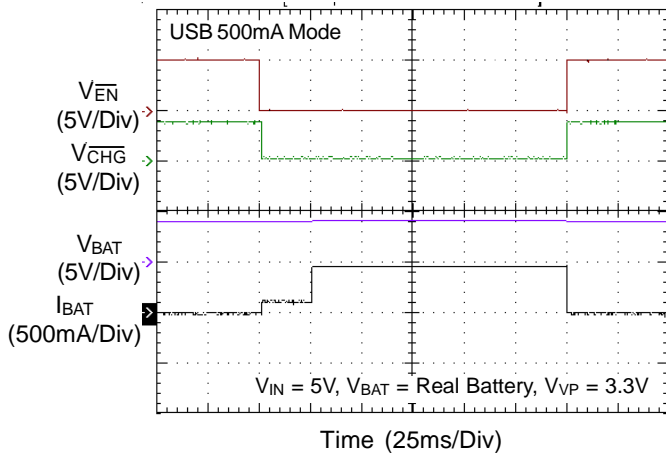

Charger On/Off Control from  $V_{IN}$

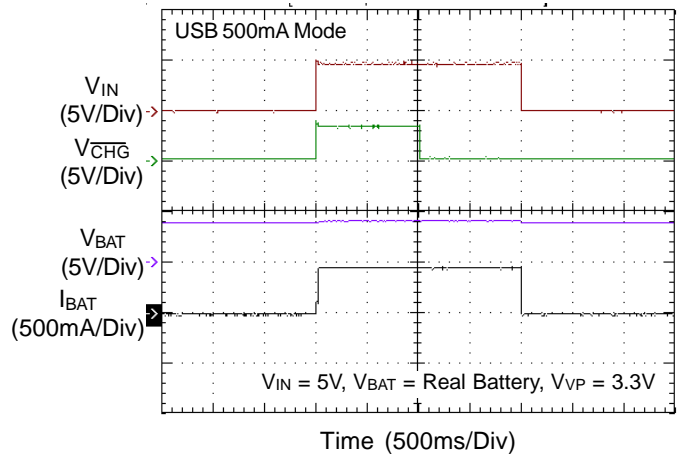

TS Inserted/Removed

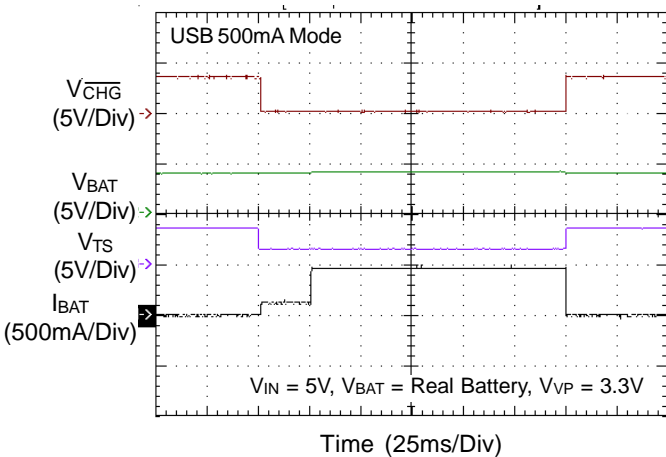

$V_{IN}$  Removal

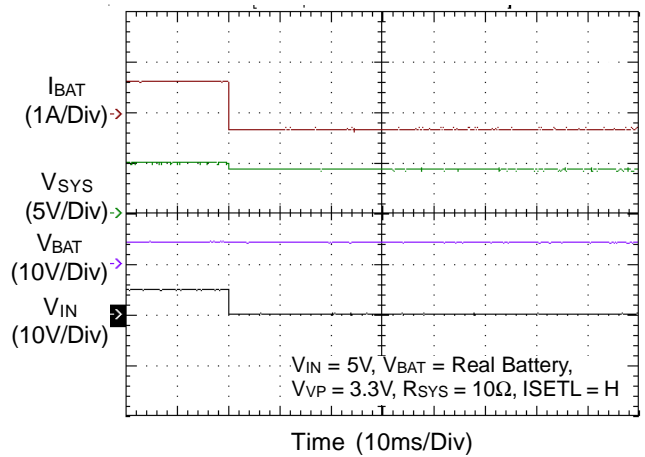

$V_{IN}$  Hot-plug with NTC/without Battery

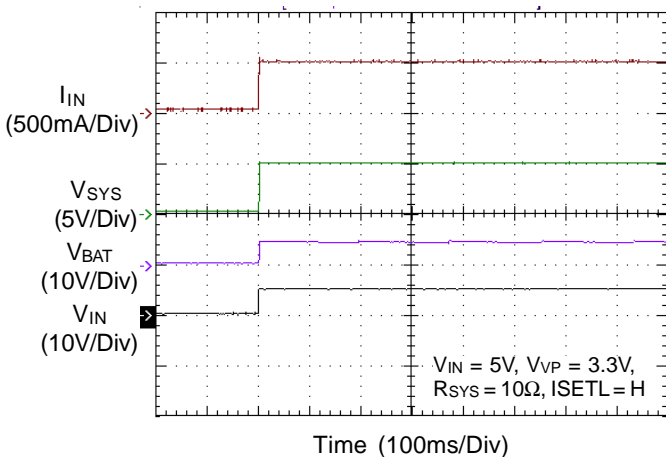

$V_{IN}$  Hot-plug without NVC/Battery

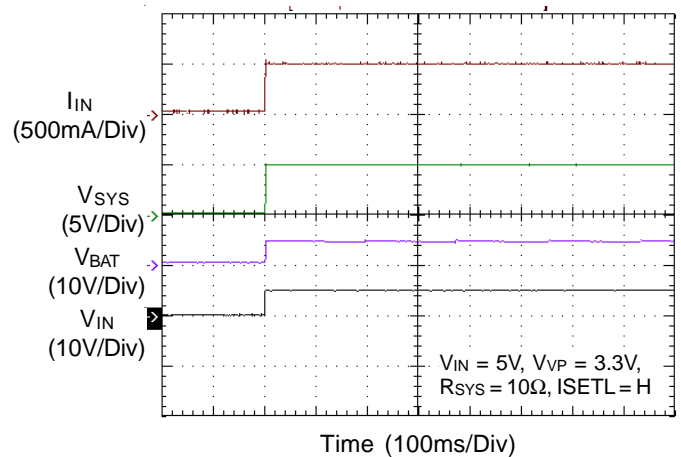

**V<sub>IN</sub> Hot-plug with Battery**

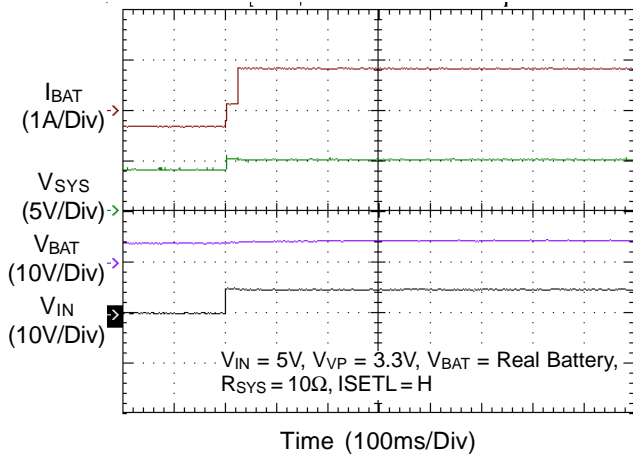

**V<sub>IN</sub> Over Voltage Protection**

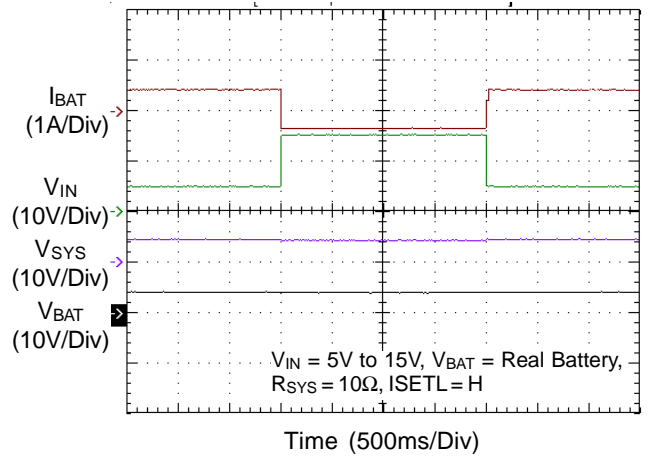

**System Regulation Voltage vs. Temperature**

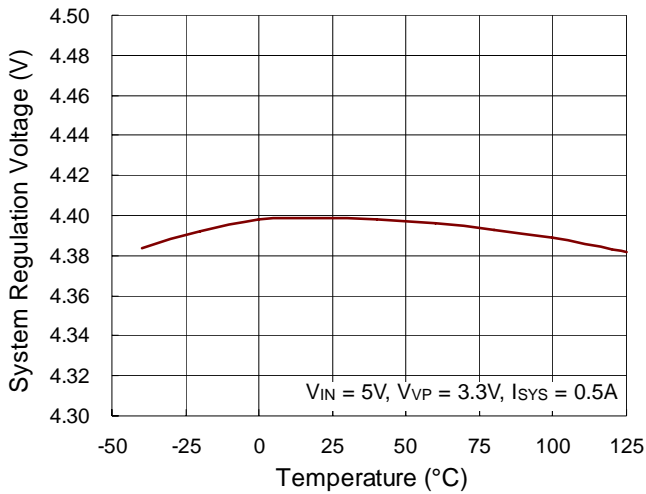

**OVP Threshold Voltage vs. Temperature**

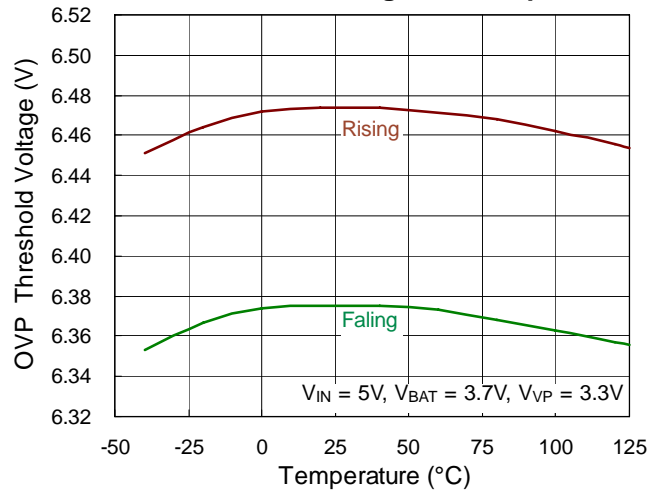

**V<sub>IN</sub> - V<sub>sys</sub> Dropout Voltage vs. Temperature**

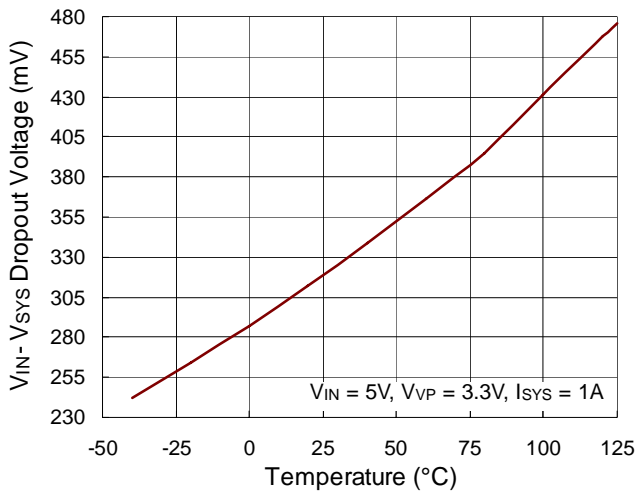

**V<sub>BAT</sub> - V<sub>sys</sub> Dropout Voltage vs. Temperature**

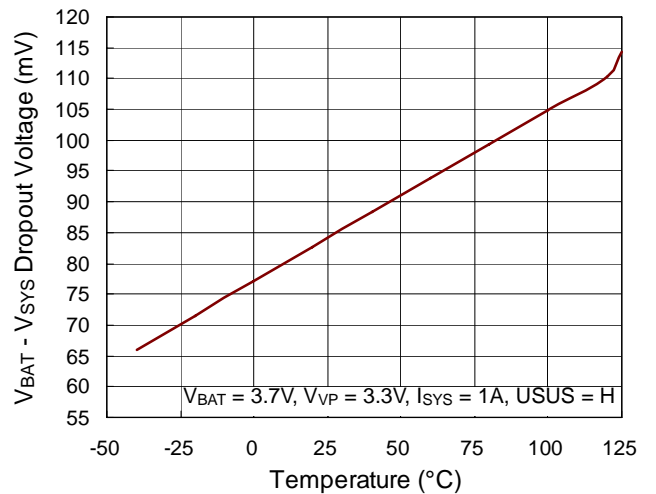



$I_{CHG}$  Thermal Regulation vs. Temperature

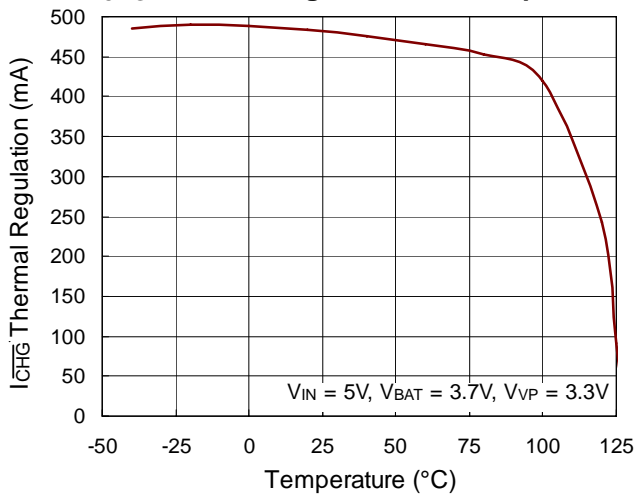

Battery Regulation Voltage vs. Temperature

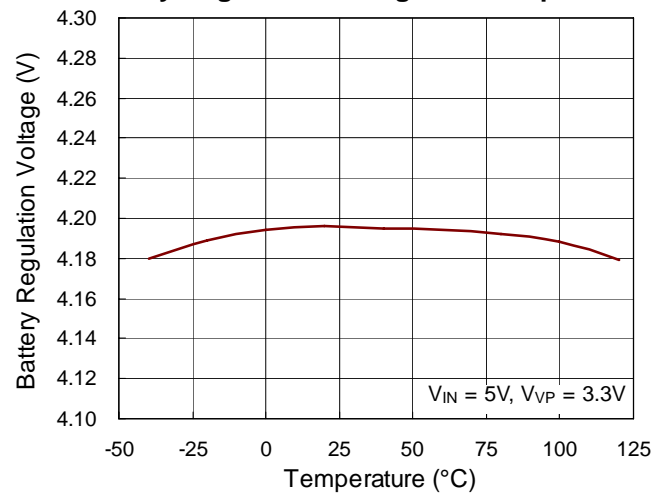

Precharge Current vs. Battery Voltage

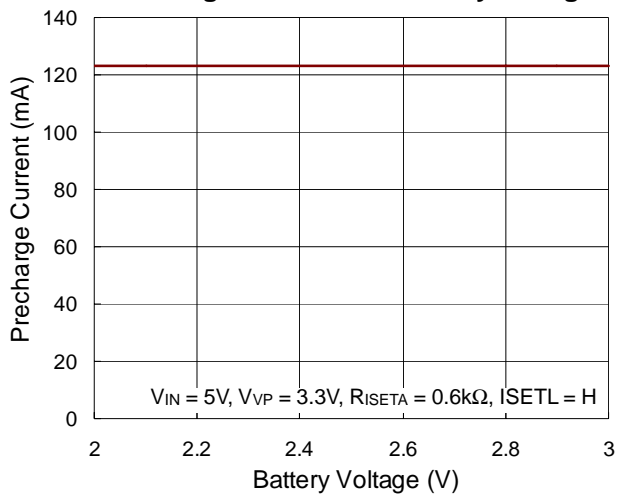

Fastcharge Current vs. Battery Voltage

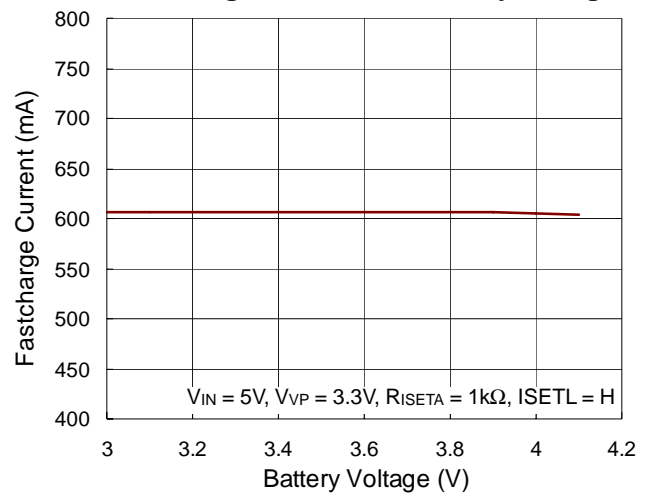

## Applications Information

The RT9519B is a fully integrated single-cell Li-ion battery charger ideal for portable applications. The internal thermal feedback circuitry regulates the die temperature to optimize the charge rate for all ambient temperatures. Other features include under voltage protection and over voltage protection.

### Pre-charge Mode

When the output voltage is lower than 2.8V, the charging current will be reduce to a fast-charge current ratio set by  $R_{ISETA}$  to protect the battery life time.

### Fast-charge Mode

When the output voltage is higher than 3V, the charging current will be equal to the fast-charge current set by  $R_{ISETA}$ .

### Constant Voltage Mode

When the output voltage is near 4.2V, and the charging current fall below the termination current, after a deglitch time check of 25ms, the charger will become disabled and  $\overline{CHG}$  will go from L to H.

### Re-charge Mode

When the chip is in charge termination mode, the charging current will gradually go down to zero. However, once the voltage of the battery drops to below 4.1V, there will be a deglitch time of 100ms and then the charging current will resume again.

### Charging Current Decision

The charge current can be set according to the following equations :

If  $I_{SET} = H$  (for  $I_{CHG1}$ )

$$I_{CHG\_FAST} = \frac{V_{ISETA}}{R_{ISETA}} \times 300$$

If  $I_{SET} = L$  (for  $I_{CHG2}$ )

$$I_{CHG\_FAST} = \frac{V_{ISETA}}{R_{ISETA}} \times 150$$

$$I_{CHG\_PRE} = 10\% \times I_{CHG\_FAST}$$

### Time Fault

During the fast charge phase, several events may increase the charging time.

For example the system load current may have activated the APPM loop which reduces the available charging current. the device has entered thermal regulation because the IC junction temperature has exceeded  $T_{REG}$ .

During each of these events, if  $3V < V_{BAT} < 4.1V$ , the internal charging time is slowed down proportionately to the reduction in charging current. However, once the duration exceed the fault time, the  $\overline{CHG}$  output will flash at approximately 2Hz to indicate a fault condition and the charge current will be reduced to about 1mA.

$$t_{FCHG\_true} = t_{FCHG} \times \frac{2V}{V_{ISETA}}$$

$t_{FCHG\_true}$  : modified timer in fast

$t_{FCHG}$  : original timer in fast charger

$$t_{FCHG} = 14400 \text{ sec} \times \left( \frac{C_{TIMER}}{1\mu F} \right)$$

$$t_{PCHG} = \frac{t_{FCHG}}{8}$$

$t_{PCHG}$  : timer in pre-charge

Time fault release methods :

- (1) Re-plug power
- (2) Toggle  $\overline{EN}$
- (3) Enter/exit suspend mode
- (4) Remove Battery
- (5) OVP

If  $ISET = H$  (for  $I_{CHG1}$ )

$$\text{timer} = t_{FCHG}$$

If  $ISET = L$  (for  $I_{CHG2}$ )

$$\text{timer} = 2 \times t_{FCHG}$$

### Power Good

VIN Power Good ( $\overline{PGOOD} = L$ )

Input State	PGOOD Output
$V_{IN} < V_{UVLO}$	High Impedance
$V_{UVLO} < V_{IN} < V_{BAT} + V_{OS\_H}$	High Impedance
$V_{BAT} + V_{OS\_H} < V_{IN} < V_{OVP}$	Low Impedance
$V_{IN} > V_{OVP}$	High Impedance

**Charge State Indicator**

Charge State	CHG Output
Charging	Low (for first charge cycle)
Charging Suspended by Thermal Loop	
Safety Timers Expired	2Hz Flash
Charging Done	High Impedance
Recharging after Termination	
IC Disabled or no Valid Input Power	

**Battery Pack Temperature Monitoring**

The battery pack temperature monitoring function can be realized by connecting the TS pin to an external Negative Temperature Coefficient (NTC) thermistor to prevent over temperature condition. Charging is suspended when the voltage at the TS pin is out of normal operating range. The internal timer is then paused, but the value is maintained. When the TS pin voltage returns back to normal operating range, charging will resume and the safe charge timer will continue to count down from the point where it was suspended. Note that although charging is suspended due to the battery pack temperature fault, the CHG pin will continue to remain low and indicate charging.

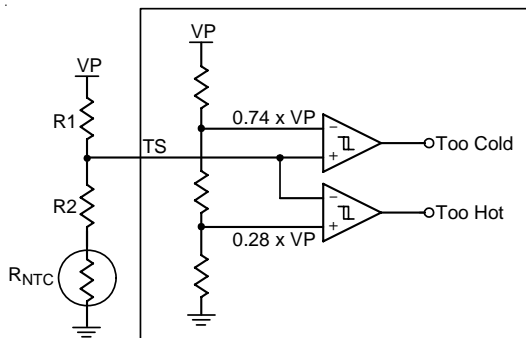

Figure 1

Too Cold Temperature

$$R_{COLD} = R_{NTC}$$

Too Hot Temperature

$$R_{HOT} = R_{NTC}$$

$$\frac{R2 + R_{COLD}}{R_{COLD} + R1 + R2} = 0.74 \tag{1}$$

$$\frac{R2 + R_{HOT}}{R_{HOT} + R1 + R2} = 0.28 \tag{2}$$

From (1), (2)

$$R1 = \frac{R_{COLD} - R_{HOT}}{2.457}$$

$$R2 = 0.389 \times R1 - R_{HOT}$$

If  $R2 < 0$

$$\frac{R_{COLD}}{R_{COLD} + R1} = 0.74 \tag{3}$$

From (3)

$$R1 = \frac{R_{COLD}}{0.74} - R_{COLD}$$

**Charge Enable**

When EN is low, the charger turns on. When EN is high, the charger turns off. EN is pulled low for initial condition.

**VIN input Current Limit**

ISETL	ISETU	VIN Input Current Limit
L	L	95mA
L	H	475mA
H	X	1.5A

**Suspend Mode**

Set USUS = H, and the charge will enter Suspend Mode. In the Suspend Mode, CHG is in high impedance and  $I_{USUS(MAX)} < 300\mu A$ .

**Power Switch**

For the RT9519B, there are three power scenarios:

(1) When a battery and an external power supply (USB or adapter) are connected simultaneously :

If the system load requirements exceed that of the input current limit, the battery will be used to supplement the current to the load. However, if the system load requirements are less than that of the input current limit, the excess power from the external power supply will be used to charge the battery.

(2) When only the battery is connected to the system :

The battery provides the power to the system.

(3) When only an external power supply is connected to the system :

The external power supply provides the power to the system.

### Input DPM Mode

For the RT9519B, the input voltage is monitored when the USB100 or USB500 is selected. If the input voltage is lower than  $V_{DPM}$ , the input current limit will be reduced to stop the input voltage from dropping any further. This can prevent the IC from damaging improperly configured or inadequately designed USB sources.

### APPM Mode

Once the sum of the charging and system load currents becomes higher than the maximum input current limit, the SYS pin voltage will be reduced. When the SYS pin voltage is reduced to the  $V_{APPM}$ , the RT9519B will automatically operate in APPM mode. In this mode, the charging current is reduced while the SYS current is increased to maintain system output. In APPM mode, the battery termination function is disabled.

### Battery Supplement Mode Short Circuit Protect

In APPM mode, the SYS voltage will continue to drop if the charge current is zero and the system load increases beyond the input current limit. When the SYS voltage decreases below the battery voltage, the battery will kick in to supplement the system load until the SYS voltage rises above the battery voltage.

While in supplement mode, there is no battery supplement current regulation. However, a built in short circuit protection feature is available to prevent any abnormal current situations. While the battery is supplementing the load, if the difference between the battery and SYS voltage becomes more than the short circuit threshold voltage, SYS will be disabled. After a short circuit recovery time,  $t_{SHORT\_R}$ , the counter will be restarted. In supplement mode, the battery termination function is disabled. Note that for the battery supply mode exit condition,  $V_{BAT} - V_{SYS} < 0V$ .

### Thermal Regulation and Thermal Shutdown

The RT9519B provides a thermal regulation loop function to monitor the device temperature. If the die temperature rises above the regulation temperature,  $T_{REG}$ , the charge current will automatically be reduced to lower the die temperature. However, in certain circumstances (such as high VIN, heavy system load, etc.) even with the thermal loop in place, the die temperature may still continue to increase. In this case, if the temperature rises above the thermal shutdown threshold,  $T_{SD}$ , the internal switch between VIN and SYS will be turned off. The switch between the battery and SYS will remain on, however, to allow continuous battery power to the load. Once the die temperature decreases by  $\Delta T_{SD}$ , the internal switch between VIN and SYS will be turned on again and the device returns to normal thermal regulation.

### Charging Profile

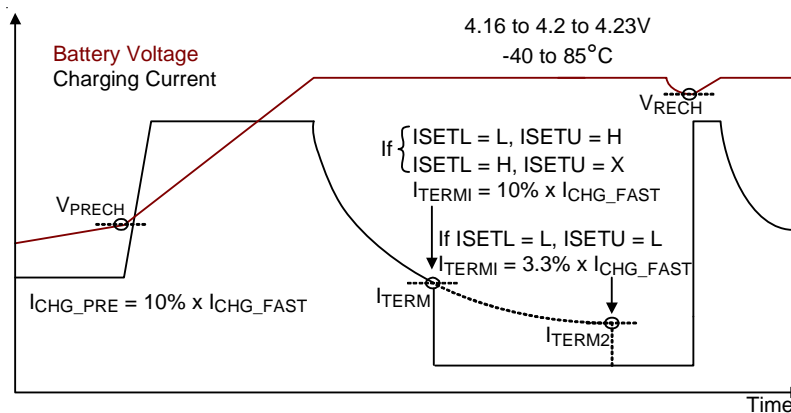
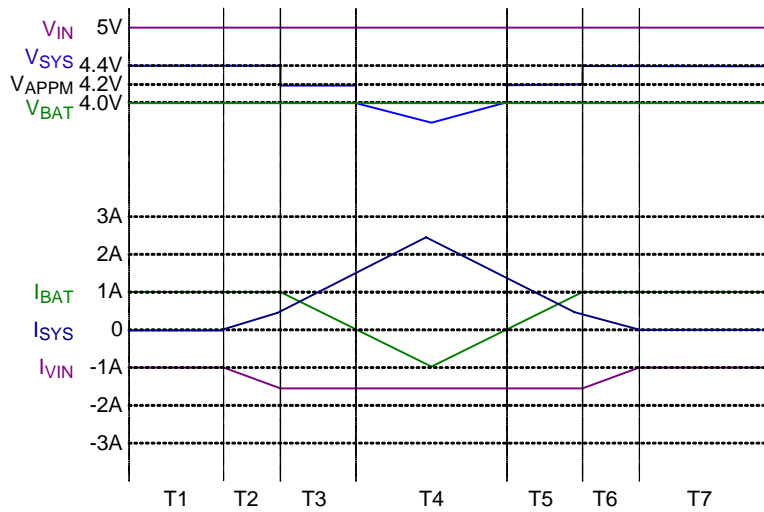

Figure 2

APPM Profile

1.5A Mode :



	<b>I<sub>sys</sub></b>	<b>V<sub>sys</sub></b>	<b>I<sub>vin</sub></b>	<b>I<sub>bat</sub></b>
T1, T7	0	SYS Regulation Voltage	CHG_MAX	CHG_MAX
T2, T6	$< I_{VIN\_OC} - CHG\_MAX$	SYS Regulation Voltage	$I_{SYS} + CHG\_MAX$	CHG_MAX
T3, T5	$> I_{VIN\_OC} - CHG\_MAX$ $< I_{VIN\_OCs}$	Auto Charge Voltage Threshold	$V_{IN\_OC}$	$V_{IN\_OC} - I_{SYS}$
T4	$> I_{VIN\_OC}$	$V_{BAT} - I_{BAT} \times R_{DS(ON)}$	$V_{IN\_OC}$	$I_{SYS} - I_{VIN\_OC}$

USB 500mA Mode :

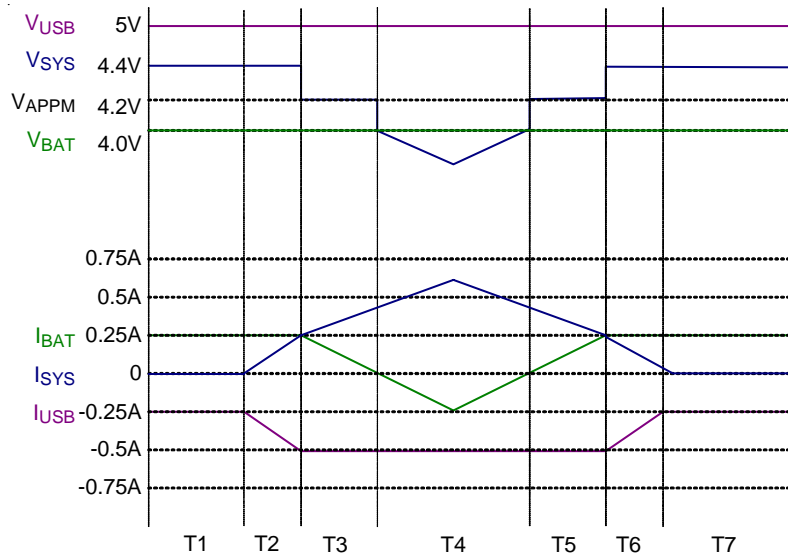

	<b>I<sub>sys</sub></b>	<b>V<sub>sys</sub></b>	<b>I<sub>usb</sub></b>	<b>I<sub>bat</sub></b>
T1, T7	0	SYS Regulation Voltage	CHG_MAX	CHG_MAX
T2, T6	$< I_{VIN\_OC} (USB) - CHG\_MAX$	SYS Regulation Voltage	$I_{SYS} + CHG\_MAX$	CHG_MAX
T3, T5	$> I_{VIN\_OC} (USB) - CHG\_MAX$ $< I_{VIN\_OC} (USB)$	Auto Charge Voltage Threshold	$I_{VIN\_OC} (USB)$	$I_{VIN\_OC} (USB) - I_{SYS}$
T4	$> I_{VIN\_OC} (USB)$	$V_{BAT} - I_{BAT} \times R_{DS(ON)}$	$I_{VIN\_OC} (USB)$	$I_{SYS} - I_{VIN\_OC} (USB)$

## VSET vs V<sub>REG</sub> , ISET vs I<sub>CHG</sub>

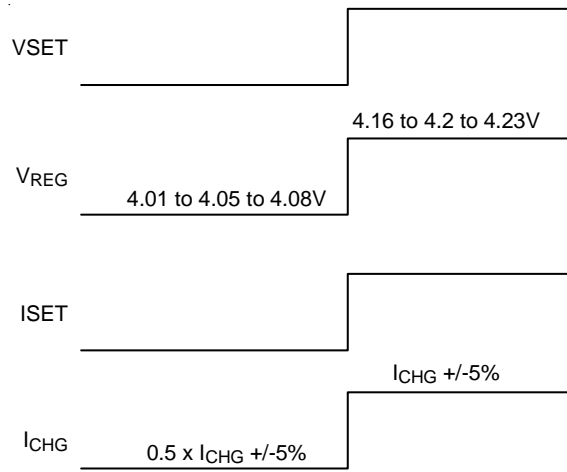

For JEITA Battery Temperature Standard :  
 CV regulation voltage will change at the following battery Temp ranges  
 0°C to 10°C and 45°C to 60°C  
 CC regulation current will change at the following battery Temp ranges  
 0°C to 10°C and 45°C to 60°C

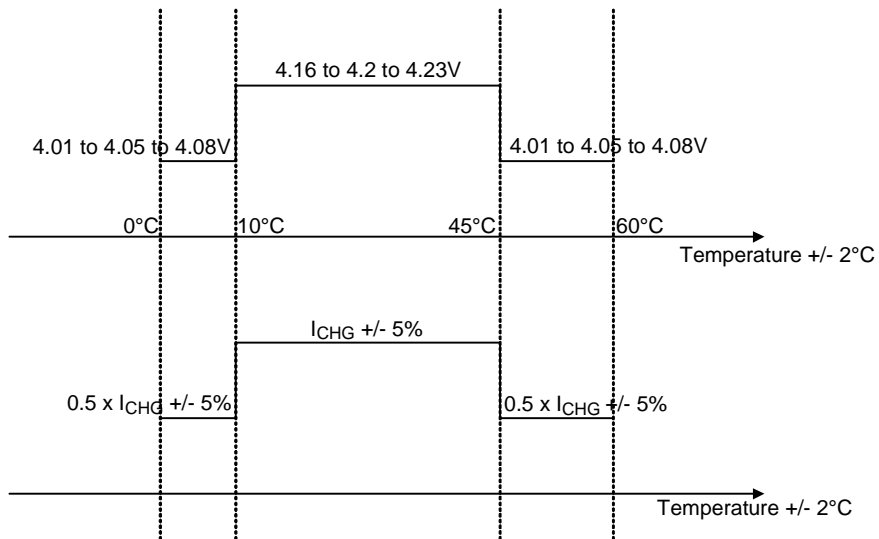

RT9519B Operation State Diagram for Charging

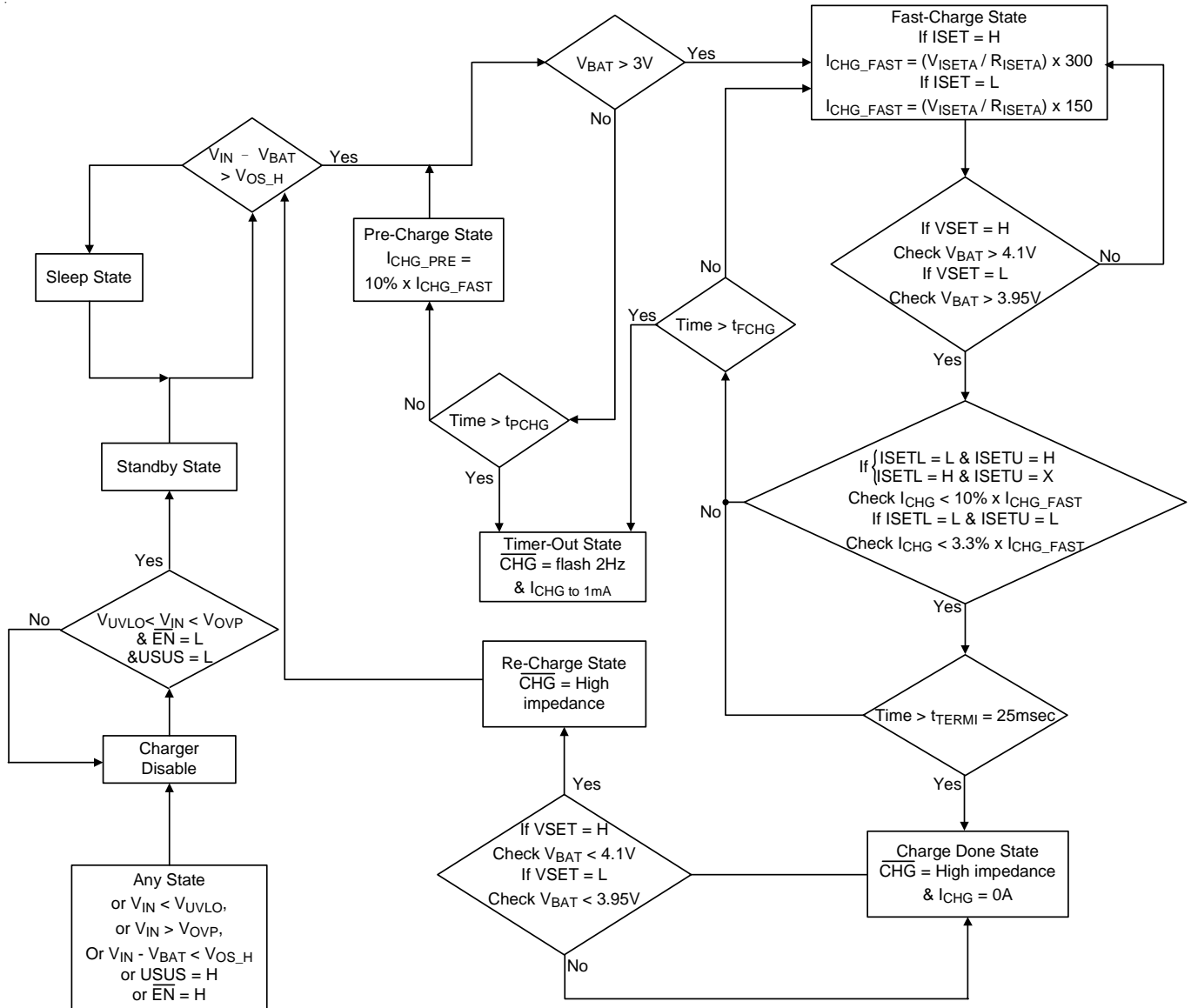

Operation State Diagram for TS PIN

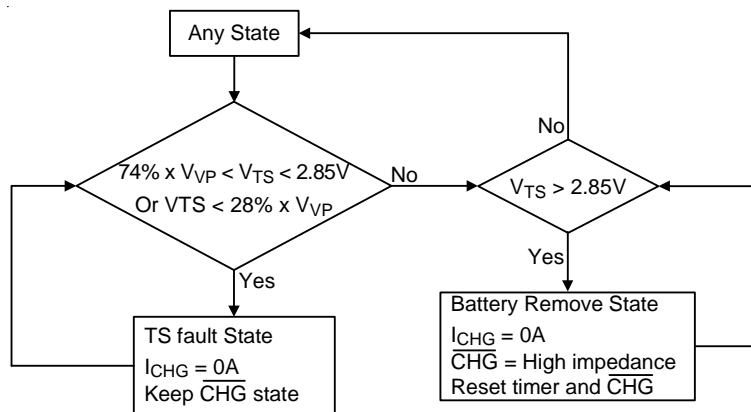

### Thermal Considerations

For continuous operation, do not exceed absolute maximum junction temperature. The maximum power dissipation depends on the thermal resistance of the IC package, PCB layout, rate of surrounding airflow, and difference between junction and ambient temperature. The maximum power dissipation can be calculated by the following formula :

$$P_{D(MAX)} = (T_{J(MAX)} - T_A) / \theta_{JA}$$

where  $T_{J(MAX)}$  is the maximum junction temperature,  $T_A$  is the ambient temperature, and  $\theta_{JA}$  is the junction to ambient thermal resistance.

For recommended operating condition specifications of the RT9519B, the maximum junction temperature is 125°C and  $T_A$  is the ambient temperature. The junction to ambient thermal resistance,  $\theta_{JA}$ , is layout dependent. For WQFN-20L 3x3 packages, the thermal resistance,  $\theta_{JA}$ , is 68°C/W on a standard JEDEC 51-7 four-layer thermal test board. The maximum power dissipation at  $T_A = 25^\circ\text{C}$  can be calculated by the following formula :

$$P_{D(MAX)} = (125^\circ\text{C} - 25^\circ\text{C}) / (68^\circ\text{C/W}) = 1.471\text{W for WQFN-20L 3x3 package}$$

The maximum power dissipation depends on the operating ambient temperature for fixed  $T_{J(MAX)}$  and thermal resistance,  $\theta_{JA}$ . For the RT9519B package, the derating curve in Figure 3 allows the designer to see the effect of rising ambient temperature on the maximum power dissipation.

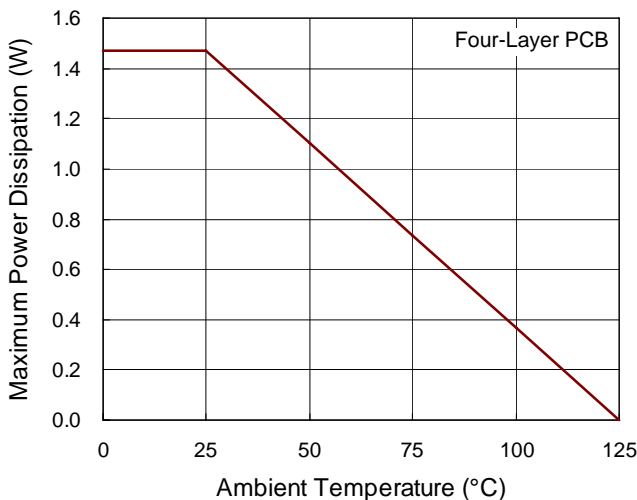

Figure 3. Derating Curves for RT9519B Package

### Layout Considerations

The RT9519B is a fully integrated low cost single cell Li-ion battery charger ideal for portable applications. Careful PCB layout is necessary. For best performance, place all peripheral components as close to the IC as possible.

A short connection is highly recommended. The following guidelines should be strictly followed when designing a PCB layout for the RT9519B.

- ▶ Input and output capacitor should be placed close to the IC and connected to ground plane. The input trace on the PCB should be placed far away from sensitive devices and shielded by the ground.
- ▶ The GND and exposed pad should be connected to a strong ground plane for heat sinking and noise protection.
- ▶ The connection of RISETA should be isolated from other noisy traces. A short wire is recommended to prevent EMI and noise coupling.



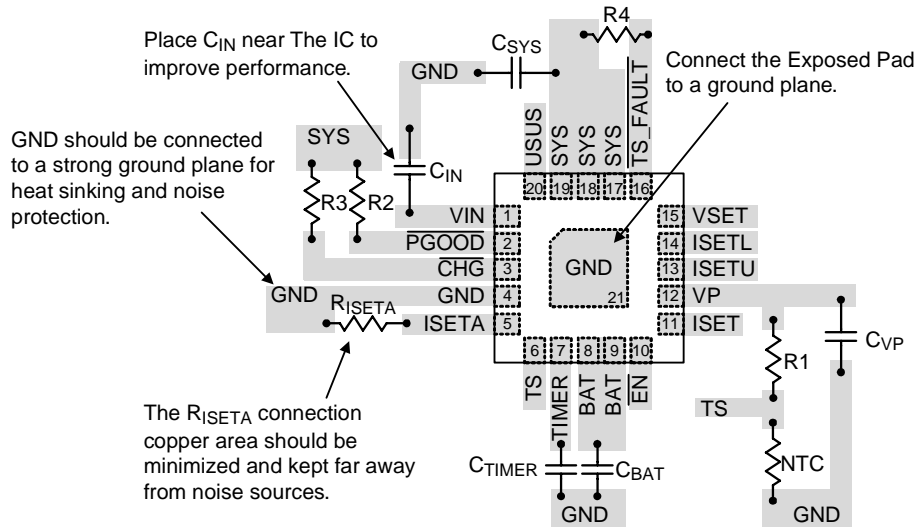
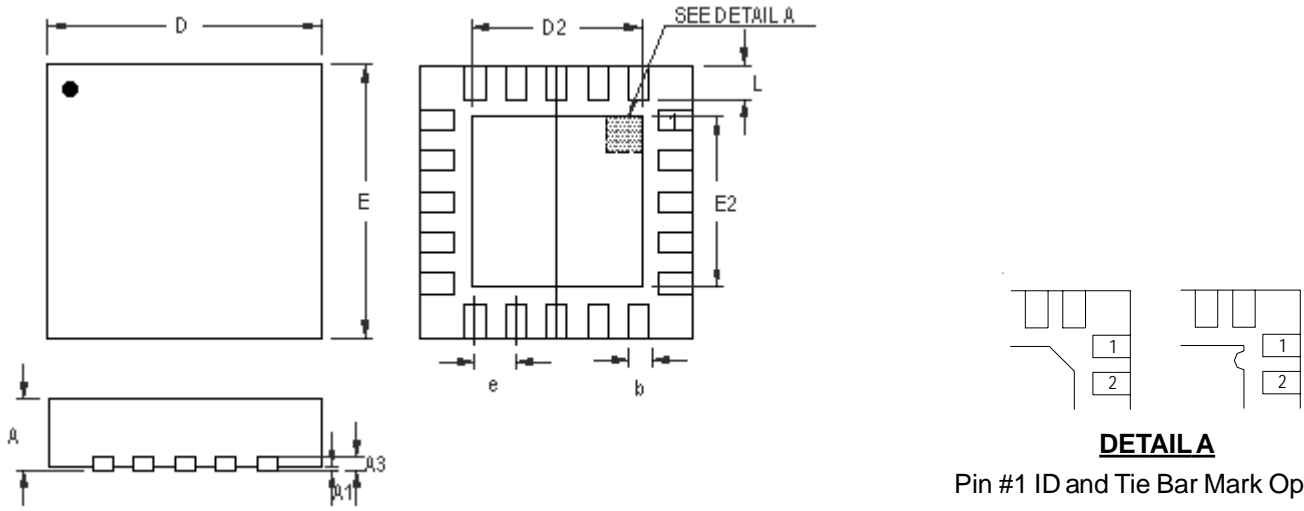

Figure 4. PCB Layout Guide

Outline Dimension



Pin #1 ID and Tie Bar Mark Options

Note : The configuration of the Pin #1 identifier is optional, but must be located within the zone indicated.

Symbol	Dimensions In Millimeters		Dimensions In Inches	
	Min	Max	Min	Max
A	0.700	0.800	0.028	0.031
A1	0.000	0.050	0.000	0.002
A3	0.175	0.250	0.007	0.010
b	0.150	0.250	0.006	0.010
D	2.900	3.100	0.114	0.122
D2	1.650	1.750	0.065	0.069
E	2.900	3.100	0.114	0.122
E2	1.650	1.750	0.065	0.069
e	0.400		0.016	
L	0.350	0.450	0.014	0.018

W-Type 20L QFN 3x3 Package

Richtek Technology Corporation

Headquarter  
 5F, No. 20, Taiyuen Street, Chupei City  
 Hsinchu, Taiwan, R.O.C.  
 Tel: (8863)5526789 Fax: (8863)5526611

Richtek Technology Corporation

Taipei Office (Marketing)  
 5F, No. 95, Minchiuan Road, Hsintien City  
 Taipei County, Taiwan, R.O.C.  
 Tel: (8862)86672399 Fax: (8862)86672377  
 Email: marketing@richtek.com

Information that is provided by Richtek Technology Corporation is believed to be accurate and reliable. Richtek reserves the right to make any change in circuit design, specification or other related things if necessary without notice at any time. No third party intellectual property infringement of the applications should be guaranteed by users when integrating Richtek products into any application. No legal responsibility for any said applications is assumed by Richtek.