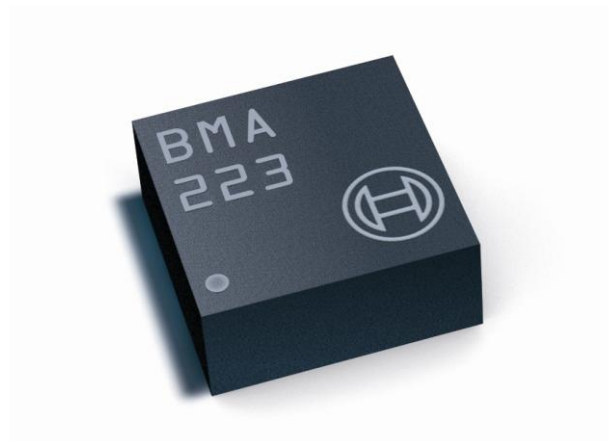

Preliminary data sheet

BMA223

Digital, triaxial acceleration sensor

Bosch Sensortec

**BOSCH**
Invented for life**BMA223: Preliminary data sheet**

Document revision	0.7
Document release date	04 April 2013
Document number	BST-BMA223-DS000-00
Technical reference code(s)	0 273 141 188
Notes	Data in this document are preliminary and subject to change without notice. Product photos and pictures are for illustration purposes only and may differ from the real product's appearance. Confidential and under NDA

 BOSCH	BMA223 Preliminary data sheet	Page 2 Confidential
--	---	------------------------

BMA223

8 BIT, DIGITAL, TRIAXIAL ACCELERATION SENSOR WITH INTELLIGENT ON-CHIP MOTION-TRIGGERED INTERRUPT CONTROLLER

Key features

- | | |
|--|--|
| <ul style="list-style-type: none"> • Ultra-Small package • Digital interface • Programmable functionality • On-chip FIFO • On-chip interrupt controller | LGA package (12 pins), footprint 2mm x 2mm, height 0.95mm
SPI (4-wire, 3-wire), I ² C, 2 interrupt pins
V _{DDIO} voltage range: 1.2V to 3.6V
Acceleration ranges $\pm 2g/\pm 4g/\pm 8g/\pm 16g$
Low-pass filter bandwidths 1kHz - <8Hz
Integrated FIFO with a depth of 32 frames
Motion-triggered interrupt-signal generation for <ul style="list-style-type: none"> - new data - any-motion (slope) detection - tap sensing (single tap / double tap) - orientation recognition - flat detection - low-g/high-g detection - no-motion / inactivity detection |
| <ul style="list-style-type: none"> • Ultra-low power • Temperature sensor • RoHS compliant, halogen-free | Low current consumption, short wake-up time, advanced features for system power management |

Typical applications

- Display profile switching
- Menu scrolling, tap / double tap sensing
- Gaming
- Pedometer / step counting
- Free-fall detection
- E-compass tilt compensation
- Drop detection for warranty logging
- Advanced system power management for mobile applications

General description

The BMA223 is a triaxial, low-g acceleration sensor with digital output for consumer applications. It allows measurements of acceleration in three perpendicular axes. An evaluation circuitry (ASIC) converts the output of a micromechanical acceleration-sensing structure (MEMS) that works according to the differential capacitance principle.

Package and interfaces of the BMA223 have been defined to match a multitude of hardware requirements. Since the sensor features an ultra-small footprint and a flat package it is ingeniously suited for mobile applications.

The BMA223 offers a variable V_{DDIO} voltage range from 1.2V to 3.6V and can be programmed to optimize functionality, performance and power consumption in customer specific applications.

 BOSCH	BMA223 Preliminary data sheet	Page 3 Confidential
--	---	------------------------

In addition it features an on-chip interrupt controller enabling motion-based applications without use of a microcontroller.

The BMA223 senses tilt, motion, inactivity and shock vibration in cell phones, handhelds, computer peripherals, man-machine interfaces, virtual reality features and game controllers.

 BOSCH	BMA223 Preliminary data sheet	Page 4 Confidential
--	---	------------------------

Index of Contents

1. SPECIFICATION	8
2. ABSOLUTE MAXIMUM RATINGS	11
3. BLOCK DIAGRAM	12
4. FUNCTIONAL DESCRIPTION.....	13
4.1 SUPPLY VOLTAGE AND POWER MANAGEMENT	13
4.2 POWER MODES.....	14
4.3 SENSOR DATA	18
4.3.1 ACCELERATION DATA	18
4.3.2 TEMPERATURE SENSOR	19
4.4 SELF-TEST	20
4.5 OFFSET COMPENSATION	21
4.5.1 SLOW COMPENSATION	23
4.5.2 FAST COMPENSATION.....	23
4.5.3 MANUAL COMPENSATION.....	24
4.5.4 INLINE CALIBRATION	24
4.6 NON-VOLATILE MEMORY	25
4.7 INTERRUPT CONTROLLER	26
4.7.1 GENERAL FEATURES	26
4.7.2 MAPPING TO PHYSICAL INTERRUPT PINS (INTTYPE TO INT PIN#).....	27
4.7.3 ELECTRICAL BEHAVIOUR (INT PIN# TO OPEN-DRIVE OR PUSH-PULL)	28
4.7.4 NEW DATA INTERRUPT.....	28
4.7.5 SLOPE / ANY-MOTION DETECTION	29
4.7.6 TAP SENSING	31
4.7.7 ORIENTATION RECOGNITION	34
4.7.8 FLAT DETECTION.....	39
4.7.9 LOW-G INTERRUPT	40
4.7.10 HIGH-G INTERRUPT	41
4.7.11 NO-MOTION / SLOW MOTION DETECTION.....	42
4.8 SOFTRESET.....	44
5. FIFO OPERATION	45
5.1 FIFO OPERATING MODES	45
5.2 FIFO DATA READOUT	46
5.3 FIFO FRAME COUNTER AND OVERRUN FLAG	46
5.4 FIFO INTERRUPTS	47

 BOSCH	BMA223 Preliminary data sheet	Page 5 Confidential
--	---	------------------------

6. REGISTER DESCRIPTION	48
6.1 GENERAL REMARKS	48
6.2 REGISTER MAP	49
REGISTER 0x00 (BGW_CHIPID)	50
REGISTER 0x02 (ACCD_X_LSB)	50
REGISTER 0x03 (ACCD_X_MSB)	51
REGISTER 0x04 (ACCD_Y_LSB)	52
REGISTER 0x05 (ACCD_Y_MSB)	53
REGISTER 0x06 (ACCD_Z_LSB)	54
REGISTER 0x07 (ACCD_Z_MSB)	55
REGISTER 0x08 (ACCD_TEMP)	56
REGISTER 0x09 (INT_STATUS_0).....	57
REGISTER 0x0A (INT_STATUS_1)	58
REGISTER 0x0B (INT_STATUS_2)	59
REGISTER 0x0C (INT_STATUS_3)	60
REGISTER 0x0E (FIFO_STATUS).....	61
REGISTER 0x0F (PMU_RANGE).....	62
REGISTER 0x10 (PMU_BW).....	62
REGISTER 0x11 (PMU_LPW).....	63
REGISTER 0x12 (PMU_LOW_POWER).....	64
REGISTER 0x13 (ACCD_HBW)	65
REGISTER 0x14 (BGW_SOFTRESET).....	66
REGISTER 0x16 (INT_EN_0).....	66
REGISTER 0x17 (INT_EN_1).....	67
REGISTER 0x18 (INT_EN_2).....	68
REGISTER 0x19 (INT_MAP_0)	69
REGISTER 0x1A (INT_MAP_1).....	70
REGISTER 0x1B (INT_MAP_2).....	71
REGISTER 0x1E (INT_SRC).....	72
REGISTER 0x20 (INT_OUT_CTRL)	73
REGISTER 0x21 (INT_RST_LATCH)	74
REGISTER 0x22 (INT_0).....	74
REGISTER 0x23 (INT_1).....	75
REGISTER 0x24 (INT_2).....	75
REGISTER 0x25 (INT_3).....	76

 BOSCH	BMA223 Preliminary data sheet	Page 6 Confidential
--	---	------------------------

REGISTER 0x26 (INT_4).....	76
REGISTER 0x27 (INT_5).....	77
REGISTER 0x28 (INT_6).....	78
REGISTER 0x29 (INT_7).....	78
REGISTER 0x2A (INT_8)	79
REGISTER 0x2B (INT_9)	80
REGISTER 0x2C (INT_A).....	81
REGISTER 0x2D (INT_B).....	82
REGISTER 0x2E (INT_C).....	82
REGISTER 0x2F (INT_D).....	83
REGISTER 0x30 (FIFO_CONFIG_0).....	84
REGISTER 0x32 (PMU_SELF_TEST).....	85
REGISTER 0x33 (TRIM_NVM_CTRL).....	86
REGISTER 0x34 (BGW_SPI3_WDT)	87
REGISTER 0x36 (OFC_CTRL).....	88
REGISTER 0x37 (OFC_SETTING).....	89
REGISTER 0x38 (OFC_OFFSET_X)	90
REGISTER 0x39 (OFC_OFFSET_Y).....	91
REGISTER 0x3A (OFC_OFFSET_Z)	92
REGISTER 0x3B (TRIM_GP0)	92
REGISTER 0x3C (TRIM_GP1)	93
REGISTER 0x3E (FIFO_CONFIG_1)	94
REGISTER 0x3F (FIFO_DATA).....	95
7. DIGITAL INTERFACES.....	96
7.1 SERIAL PERIPHERAL INTERFACE (SPI).....	97
7.2 INTER-INTEGRATED CIRCUIT (I ² C).....	101
7.2.1 SPI AND I ² C ACCESS RESTRICTIONS	104
8. PIN-OUT AND CONNECTION DIAGRAM	105
8.1 PIN-OUT	105
8.2 CONNECTION DIAGRAM 4-WIRE SPI	106
8.3 CONNECTION DIAGRAM 3-WIRE SPI	107
8.4 CONNECTION DIAGRAM I ² C.....	108

 BOSCH	BMA223 Preliminary data sheet	Page 7 Confidential
--	---	------------------------

9. PACKAGE	109
9.1 OUTLINE DIMENSIONS	109
9.2 SENSING AXES ORIENTATION	110
9.2 SENSING AXES ORIENTATION	110
9.3 LANDING PATTERN RECOMMENDATION	111
9.4 MARKING	112
9.4.1 MASS PRODUCTION DEVICES	112
9.4.2 ENGINEERING SAMPLES	112
9.5 SOLDERING GUIDELINES	113
9.6 HANDLING INSTRUCTIONS	114
9.7 TAPE AND REEL SPECIFICATION	115
9.7.1 ORIENTATION WITHIN THE REEL	116
9.8 ENVIRONMENTAL SAFETY	117
9.8.1 HALOGEN CONTENT	117
9.8.2 INTERNAL PACKAGE STRUCTURE	117
10. LEGAL DISCLAIMER	118
10.1 ENGINEERING SAMPLES	118
10.2 PRODUCT USE	118
10.3 APPLICATION EXAMPLES AND HINTS	118
11. DOCUMENT HISTORY AND MODIFICATION	119

 BOSCH	BMA223 Preliminary data sheet	Page 8 Confidential
--	---	------------------------

1. Specification

Unless stated otherwise, the given values are over lifetime, operating temperature and voltage ranges. Minimum/maximum values are $\pm 3\sigma$.

Table 1: Parameter specification

OPERATING CONDITIONS						
Parameter	Symbol	Condition	Min	Typ	Max	Units
Acceleration Range	g_{FS2g}	Selectable via serial digital interface		± 2		g
	g_{FS4g}			± 4		g
	g_{FS8g}			± 8		g
	g_{FS16g}			± 16		g
Supply Voltage Internal Domains	V_{DD}		1.62	2.4	3.6	V
Supply Voltage I/O Domain	V_{DDIO}		1.2	2.4	3.6	V
Voltage Input Low Level	V_{IL}	SPI & I ² C			$0.3V_{DDIO}$	-
Voltage Input High Level	V_{IH}	SPI & I ² C	$0.7V_{DDIO}$			-
Voltage Output Low Level	V_{OL}	$I_{OL} = 3mA$, SPI & I ² C			$0.2V_{DDIO}$	-
Voltage Output High Level	V_{OH}	$I_{OH} = 3mA$, SPI	$0.8V_{DDIO}$			-
Total Supply Current in Normal Mode	I_{DD}	$T_A = 25^\circ C$, bw = 1kHz		130		μA
Total Supply Current in Suspend Mode	I_{DDsum}	$T_A = 25^\circ C$		2.1		μA
Total Supply Current in Deep Suspend Mode	I_{DDdsum}	$T_A = 25^\circ C$		1		μA
Total Supply Current in Low-power Mode 1	I_{DDlp1}	$T_A = 25^\circ C$, bw = 1kHz sleep duration = 25ms		6.5		μA
Total Supply Current in Low-power Mode 2	I_{DDlp2}	$T_A = 25^\circ C$, bw = 1kHz sleep duration = 25ms		45		μA

 BOSCH	BMA223 Preliminary data sheet	Page 9 Confidential
--	---	------------------------

Total Supply Current in Standby Mode	I_{DDsbm}	$T_A=25^{\circ}\text{C}$		42		μA
Wake-Up Time 1	$t_{w,up1}$	from Low-power Mode 1 or Suspend Mode or Deep Suspend Mode $bw = 1\text{kHz}$		1.3	1.8	ms
Wake-Up Time 2	$t_{w,up2}$	from Low-power Mode 2 or Stand-by Mode $bw = 1\text{kHz}$		1	1.2	ms
Start-Up Time	$t_{s,up}$	POR, $bw = 1\text{kHz}$			3	ms
Non-volatile memory (NVM) write-cycles	n_{NVM}				15	cycles
Operating Temperature	T_A		-40		+85	$^{\circ}\text{C}$
OUTPUT SIGNAL						
Parameter	Symbol	Condition	Min	Typ	Max	Units
Sensitivity	S_{2g}	$g_{FS2g}, T_A=25^{\circ}\text{C}$		64		LSB/g
	S_{4g}	$g_{FS4g}, T_A=25^{\circ}\text{C}$		32		LSB/g
	S_{8g}	$g_{FS8g}, T_A=25^{\circ}\text{C}$		16		LSB/g
	S_{16g}	$g_{FS16g}, T_A=25^{\circ}\text{C}$		8		LSB/g
Sensitivity Temperature Drift	TCS	$g_{FS2g},$ Nominal V_{DD} supplies		± 0.02		%/K
Zero-g Offset	Off	$g_{FS2g}, T_A=25^{\circ}\text{C},$ nominal V_{DD} supplies, over life-time		± 100		mg
Zero-g Offset Temperature Drift	TCO	$g_{FS2g},$ Nominal V_{DD} supplies		± 1.5		mg/K
Bandwidth	bw_8	2 nd order filter, bandwidth programmable		8		Hz
	bw_{16}			16		Hz
	bw_{31}			31		Hz
	bw_{63}			63		Hz
	bw_{125}			125		Hz
	bw_{250}			250		Hz
	bw_{500}			500		Hz
	bw_{1000}			1,000		Hz
Nonlinearity	NL	best fit straight line, g_{FS2g}		± 0.5		%FS
Output Noise Density	n_{rms}	$g_{FS2g}, T_A=25^{\circ}\text{C}$ Nominal V_{DD} supplies Normal mode		1000		$\mu\text{g}/\sqrt{\text{Hz}}$

 BOSCH	BMA223 Preliminary data sheet	Page 10 Confidential
--	---	-------------------------

Temperature Sensor Measurement Range	T_s		-40		85	°C
Temperature Sensor Slope	dT_s			0.5		K/LSB
Temperature Sensor Offset	OT_s			±2		K

MECHANICAL CHARACTERISTICS

Parameter	Symbol	Condition	Min	Typ	Max	Units
Cross Axis Sensitivity	S	relative contribution between any two of the three axes		1		%
Alignment Error	E_A	relative to package outline		±0.5		°

 BOSCH	BMA223 Preliminary data sheet	Page 11 Confidential
--	---	-------------------------

2. Absolute maximum ratings

Table 2: Absolute maximum ratings

Parameter	Condition	Min	Max	Units
Voltage at Supply Pin	V _{DD} Pin	-0.3	4.25	V
	V _{DDIO} Pin	-0.3	4.25	V
Voltage at any Logic Pin	Non-Supply Pin	-0.3	V _{DDIO} +0.3	V
Passive Storage Temp. Range	≤ 65% rel. H.	-50	+150	°C
None-volatile memory (NVM) Data Retention	T = 85°C, after 15 cycles	10		y
Mechanical Shock	Duration ≤ 200μs		10,000	g
	Duration ≤ 1.0ms		2,000	g
	Free fall onto hard surfaces		1.8	m
ESD	HBM, at any Pin		2	kV
	CDM		500	V
	MM		200	V

Note:

Stress above these limits may cause damage to the device. Exceeding the specified electrical limits may affect the device reliability or cause malfunction.

 BOSCH	BMA223 Preliminary data sheet	Page 12 Confidential
--	---	-------------------------

3. Block diagram

Figure 1 shows the basic building blocks of the BMA223:

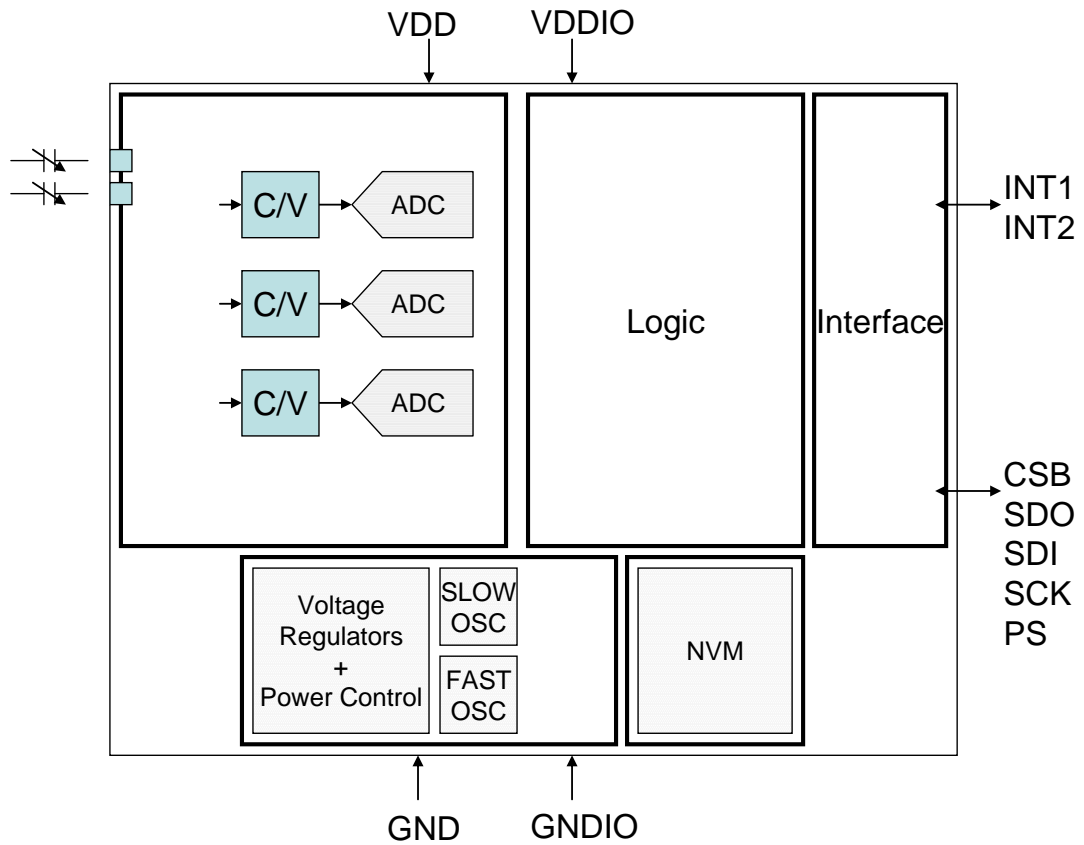



Figure 1: Block diagram of BMA223

 BOSCH	BMA223 Preliminary data sheet	Page 13 Confidential
--	---	-------------------------

4. Functional description

Note: Default values for registers can be found in chapter 6.

4.1 Supply voltage and power management

The BMA223 has two distinct power supply pins:

- V_{DD} is the main power supply for the internal blocks
- V_{DDIO} is a separate power supply pin used for supplying power for the interface

There are no limitations on the voltage levels of both pins relative to each other, as long as each of them lies within its operating range. Furthermore, the device can be completely switched off ($V_{DD} = 0V$) while keeping the V_{DDIO} supply on ($V_{DDIO} > 0V$) or vice versa.

When the V_{DDIO} supply is switched off, all interface pins (CSB, SDI, SCK, PS) must be kept close to GND_{IO} potential.

The device contains a power-on reset (POR) generator. It resets the logic part and the register values after powering-on V_{DD} and V_{DDIO} . Please note, that all application specific settings which are not equal to the default settings (refer to 6.2 register map), must be re-set to its designated values after POR.

There are no constraints on the switching sequence of both supply voltages. In case the I²C interface shall be used, a direct electrical connection between V_{DDIO} supply and the PS pin is needed in order to ensure reliable protocol selection. For SPI interface mode the PS pin must be directly connected to GND_{IO} .

 BOSCH	BMA223 Preliminary data sheet	Page 14 Confidential
--	---	-------------------------

4.2 Power modes

The BMA223 has six different power modes. Besides normal mode, which represents the fully operational state of the device, there are five energy saving modes: deep-suspend mode, suspend mode, standby mode, low-power mode 1 and low-power mode 2.

The possible transitions between the power modes are illustrated in figure 2:

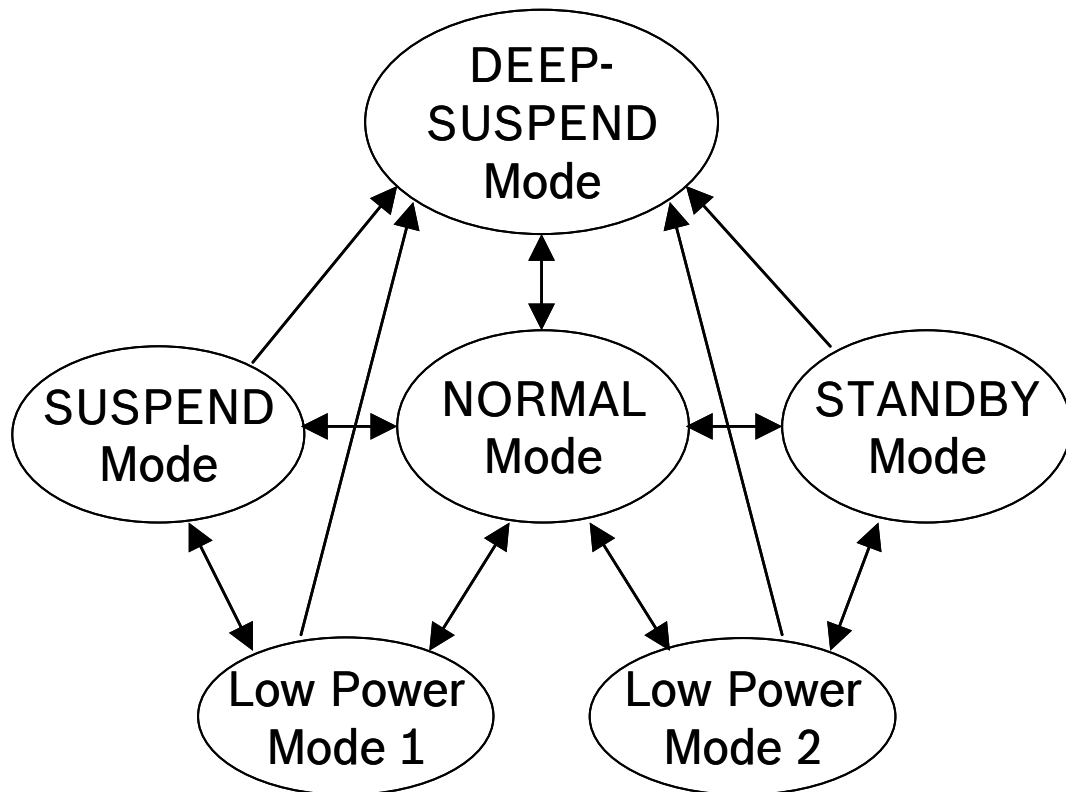



Figure 2: Power mode transition diagram

After power-up BMA223 is in normal mode so that all parts of the device are held powered-up and data acquisition is performed continuously.

In **deep-suspend** mode the device reaches the lowest possible power consumption. Only the interface section is kept alive. No data acquisition is performed and the content of the configuration registers is lost. Deep suspend mode is entered (left) by writing '1' ('0') to the (0x11) *deep_suspend* bit while (0x11) *suspend* bit is set to '0'. The I²C watchdog timer remains functional. The (0x11) *deep_suspend* bit, the (0x34) *spi3* bit, (0x34) *i2c_wdt_en* bit and the (0x34) *i2c_wdt_sel* bit are functional in deep-suspend mode. Equally the interrupt level and driver configuration registers (0x20) *int1_lvl*, (0x20) *int1_od*, (0x20) *int2_lvl*, and (0x20) *int2_od* are accessible. Still it is possible to enter normal mode by performing a softreset as described in chapter 4.8. Please note, that all application specific settings which are not equal to the default settings (refer to 6.2 register map), must be re-set to its designated values after leaving deep-suspend mode.

 BOSCH	BMA223 Preliminary data sheet	Page 15 Confidential
--	---	-------------------------

In **suspend mode** the whole analog part is powered down. No data acquisition is performed. While in suspend mode the latest acceleration data and the content of all configuration registers are kept. Writing to and reading from registers is supported except from the *(0x3F) fifo_data* register. It is possible to enter normal mode by performing a softreset as described in chapter 4.8.

Suspend mode is entered (left) by writing '1' ('0') to the *(0x11) suspend* bit after bit *(0x12) lowpower_mode* has been set to '0'. Although write access to registers is supported at the full interface clock speed (SCL or SCK), a waiting period must be inserted between two consecutive write cycles (please refer also to section 7.2.1).

In **standby mode** the analog part is powered down, while the digital part remains largely operational. No data acquisition is performed. Reading and writing registers is supported without any restrictions. The latest acceleration data and the content of all configuration registers are kept. Standby mode is entered (left) by writing '1' ('0') to the *(0x11) suspend* bit after bit *(0x12) lowpower_mode* has been set to '1'. It is also possible to enter normal mode by performing a softreset as described in chapter 4.8.

In **low-power mode 1**, the device is periodically switching between a sleep phase and a wake-up phase. The wake-up phase essentially corresponds to operation in normal mode with complete power-up of the circuitry. The sleep phase essentially corresponds to operation in suspend mode. Low-power mode is entered (left) by writing '1' ('0') to the *(0x11) lowpower_en* bit with bit *(0x12) lowpower_mode* set to '0'. Read access to registers is possible except from the *(0x3F) fifo_data* register. However, unless the register access is synchronised with the wake-up phase, the restrictions of the suspend mode apply.

Low-power mode 2 is very similar to low-power mode 1, but register access is possible at any time without restrictions. It consumes more power than low-power mode 1. In low-power mode 2 the device is periodically switching between a sleep phase and a wake-up phase. The wake-up phase essentially corresponds to operation in normal mode with complete power-up of the circuitry. The sleep phase essentially corresponds to operation in standby mode. Low-power mode is entered (left) by writing '1' ('0') to the *(0x11) lowpower_en* bit with bit *(0x12) lowpower_mode* set to '1'.

The timing behaviour of the low-power modes 1 and 2 depends on the setting of the *(0x12) sleeptimer_en* bit. When *(0x12) sleeptimer_en* is set to '0', the event-driven time-base mode (EDT) is selected. In EDT the duration of the wake-up phase depends on the number of samples required by the enabled interrupt engines. If an interrupt is detected, the device stays in the wake-up phase as long as the interrupt condition endures (non-latched interrupt), or until the latch time expires (temporary interrupt), or until the interrupt is reset (latched interrupt). If no interrupt is detected, the device enters the sleep phase immediately after the required number of acceleration samples have been taken and an active interface access cycle has ended. The EDT mode is recommended for power-critical applications which do not use the FIFO. Also, EDT mode is compatible with legacy BST sensors. Figure 3 shows the timing diagram for low-power modes 1 and 2 when EDT is selected.

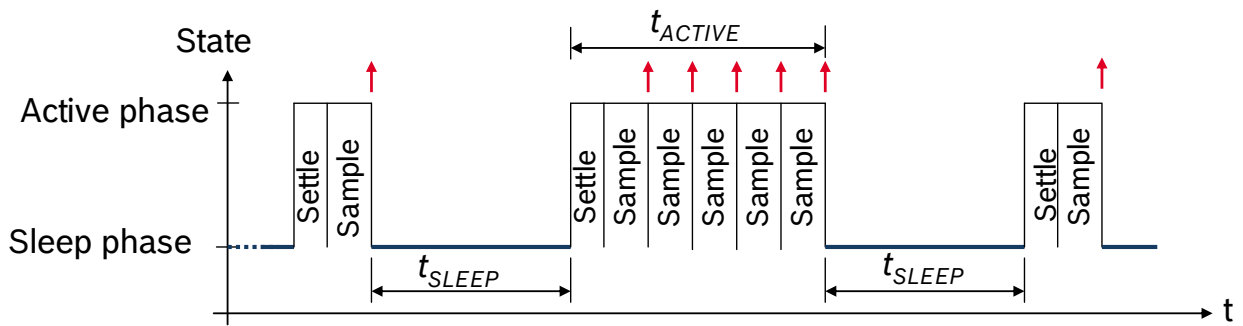

Figure 3: Timing Diagram for low-power mode 1/2, EDT

When $(0x12)$ *sleeptimer_en* is set to '1', the equidistant-sampling mode (EST) is selected. The use of the EST mode is recommended when the FIFO is used since it ensures that equidistant samples are sampled into the FIFO regardless of whether the active phase is extended by active interrupt engines or interface activity. In EST mode the sleep time t_{SLEEP} is defined as shown in Figure 4. The FIFO sampling time t_{SAMPLE} is the sum of the sleep time t_{SLEEP} and the sensor data sampling time t_{SSMP} . Since interrupt engines can extend the active phase to exceed the sleep time t_{SLEEP} , equidistant sampling is only guaranteed if the bandwidth has been chosen such that $1/(2 * bw) = n * t_{SLEEP}$ where n is an integer. If this condition is infringed, equidistant sampling is not possible. Once the sleep time has elapsed the device will store the next available sample in the FIFO. This set-up condition is not recommended as it may result in timing jitter.

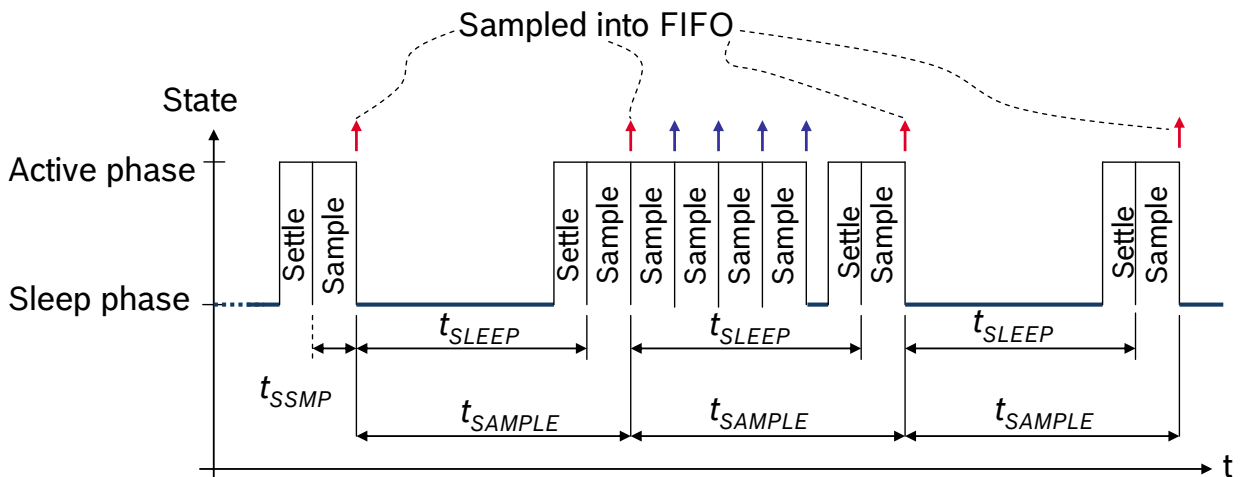



Figure 4: Timing Diagram for low-power mode 1/2, EST

 BOSCH	BMA223 Preliminary data sheet	Page 17 Confidential
--	---	-------------------------

The sleep time for lower-power mode 1 and 2 is set by the (0x11) *sleep_dur* bits as shown in the following table:

Table 3: Sleep phase duration settings

(0x11) <i>sleep_dur</i>	Sleep Phase Duration t_{sleep}
0000b	0.5ms
0001b	0.5ms
0010b	0.5ms
0011b	0.5ms
0100b	0.5ms
0101b	0.5ms
0110b	1ms
0111b	2ms
1000b	4ms
1001b	6ms
1010b	10ms
1011b	25ms
1100b	50ms
1101b	100ms
1110b	500ms
1111b	1s

The current consumption of the BMA223 in low-power mode 1 (I_{DDlp1}) and low-power mode 2 (I_{DDlp2}) can be estimated with the following formulae:

$$I_{DDlp1} \approx \frac{t_{sleep} \cdot I_{DDsum} + t_{active} \cdot I_{DD}}{t_{sleep} + t_{active}}$$

$$I_{DDlp2} \approx \frac{t_{sleep} \cdot I_{DDsbm} + t_{active} \cdot I_{DD}}{t_{sleep} + t_{active}}$$

When estimating the length of the wake-up phase t_{active} , the corresponding typical wake-up time, $t_{w,up1}$ or $t_{w,up2}$ and t_{ut} (given in Table 4) have to be considered:

If bandwidth is ≥ 31.25 Hz:

$$t_{active} = t_{ut} + t_{w,up1} - 0.9 \text{ ms (or } t_{active} = t_{ut} + t_{w,up2} - 0.9 \text{ ms)}$$

else:

$$t_{active} = 4 t_{ut} + t_{w,up1} - 0.9 \text{ ms (or } t_{active} = 4 t_{ut} + t_{w,up2} - 0.9 \text{ ms)}$$

During the wake-up phase all analog modules are held powered-up, while during the sleep phase most analog modules are powered down. Consequently, a wake-up time of more than $t_{w,up1}$ ($t_{w,up2}$) is needed to settle the analog modules so that reliable acceleration data are generated.

 BOSCH	BMA223 Preliminary data sheet	Page 18 Confidential
--	---	-------------------------

4.3 Sensor data

4.3.1 Acceleration data

The width of acceleration data is 8 bits given in two's complement representation. The 8 bit data word for each axis is contained the MSB of the acceleration data output registers 0x03, 0x05, 0x07. The LSB of the acceleration data output registers contain a (0x02, 0x04, 0x06) *new_data* flag. Reading the acceleration data registers shall always start with the LSB part. In order to ensure the integrity of the acceleration data, the content of an MSB register is locked by reading the corresponding LSB register (shadowing procedure). When shadowing is enabled, the MSB must always be read in order to remove the data lock. The shadowing procedure can be disabled (enabled) by writing '1' ('0') to the bit *shadow_dis*. With shadowing disabled, the content of both MSB and LSB registers is updated by a new value immediately. Unused bits of the LSB registers may have any value and should be ignored. The (0x02, 0x04, 0x06) *new_data* flag of each LSB register is set if the data registers have been updated. The flag is reset if either the corresponding MSB or LSB part is read.

Two different streams of acceleration data are available, unfiltered and filtered. The unfiltered data is sampled with 2kHz. The sampling rate of the filtered data depends on the selected filter bandwidth and is always twice the selected bandwidth ($BW = ODR/2$). Which kind of data is stored in the acceleration data registers depends on bit (0x13) *data_high_bw*. If (0x13) *data_high_bw* is '0' ('1'), then filtered (unfiltered) data is stored in the registers. Both data streams are offset-compensated.

The bandwidth of filtered acceleration data is determined by setting the (0x10) *bw* bit as followed:

Table 4: Bandwidth configuration

bw	Bandwidth	Update Time t_{ut}
00xxx	*)	-
01000	7.81Hz	64ms
01001	15.63Hz	32ms
01010	31.25Hz	16ms
01011	62.5Hz	8ms
01100	125Hz	4ms
01101	250Hz	2ms
01110	500Hz	1ms
01111	1000Hz	0.5ms
1xxxx	*)	-

*) Note: Settings 00xxx result in a bandwidth of 7.81 Hz; settings 1xxxx result in a bandwidth of 1000 Hz. It is recommended to actively set an application specific and an appropriate bandwidth and to use the range from '01000b' to '01111b' only in order to be compatible with future products.

 BOSCH	BMA223 Preliminary data sheet	Page 19 Confidential
--	---	-------------------------

The BMA223 supports four different acceleration measurement ranges. A measurement range is selected by setting the $(0x0F)$ range bits as follows:

Table 5: Range selection

Range	Acceleration measurement range	Resolution
0011	±2g	15.63 mg/LSB
0101	±4g	31.25 mg/LSB
1000	±8g	62.5 mg/LSB
1100	±16g	125 mg/LSB
others	reserved	-

4.3.2 Temperature sensor

The width of temperature data is 8 bits given in two's complement representation. Temperature values are available in the $(0x08)$ *temp* register.

The slope of the temperature sensor is 0.5K/LSB, its center temperature is 23°C [$(0x08)$ *temp* = 0x00].

 BOSCH	BMA223 Preliminary data sheet	Page 20 Confidential
--	---	-------------------------

4.4 Self-test

This feature permits to check the sensor functionality by applying electrostatic forces to the sensor core instead of external accelerations. By actually deflecting the seismic mass, the entire signal path of the sensor can be tested. Activating the self-test results in a static offset of the acceleration data; any external acceleration or gravitational force applied to the sensor during active self-test will be observed in the output as a superposition of both acceleration and self-test signal.

Before the self-test is enabled the g-range should be set to 8 g. The self-test is activated individually for each axis by writing the proper value to the (0x32) *self_test_axis* bits ('01b' for x-axis, '10b' for y-axis, '11b' for z-axis, '00b' to deactivate self-test). It is possible to control the direction of the deflection through bit (0x32) *self_test_sign*. The excitation occurs in negative (positive) direction if (0x32) *self_test_sign* = '0b' ('1b'). The amplitude of the deflection has to be set high by writing (0x32) *self_test_amp* = '1b'. After the self-test is enabled, the user should wait 50ms before interpreting the acceleration data.

In order to ensure a proper interpretation of the self-test signal it is recommended to perform the self-test for both (positive and negative) directions and then to calculate the difference of the resulting acceleration values. Table 6 shows the minimum differences for each axis. The actually measured signal differences can be significantly larger.

Table 6: Self-test difference values

	x-axis signal	y-axis signal	z-axis signal
resulting minimum difference signal	800 mg	800 mg	400 mg

It is recommended to perform a reset of the device after a self-test has been performed. If the reset cannot be performed, the following sequence must be kept to prevent unwanted interrupt generation: disable interrupts, change parameters of interrupts, wait for at least 50ms, enable desired interrupts.

4.5 Offset compensation

Offsets in measured signals can have several causes but they are always unwanted and disturbing in many cases. Therefore, the BMA223 offers an advanced set of four digital offset compensation methods which are closely matched to each other. These are slow, fast, and manual compensation as well as inline calibration.

The compensation is performed with unfiltered data, and is then applied to both, unfiltered and filtered data. If necessary the result of this computation is saturated to prevent any overflow errors (the smallest or biggest possible value is set, depending on the sign). However, the registers used to read and write compensation values have only a width of 8 bits.

An overview of the offset compensation principle is given in figure 5:

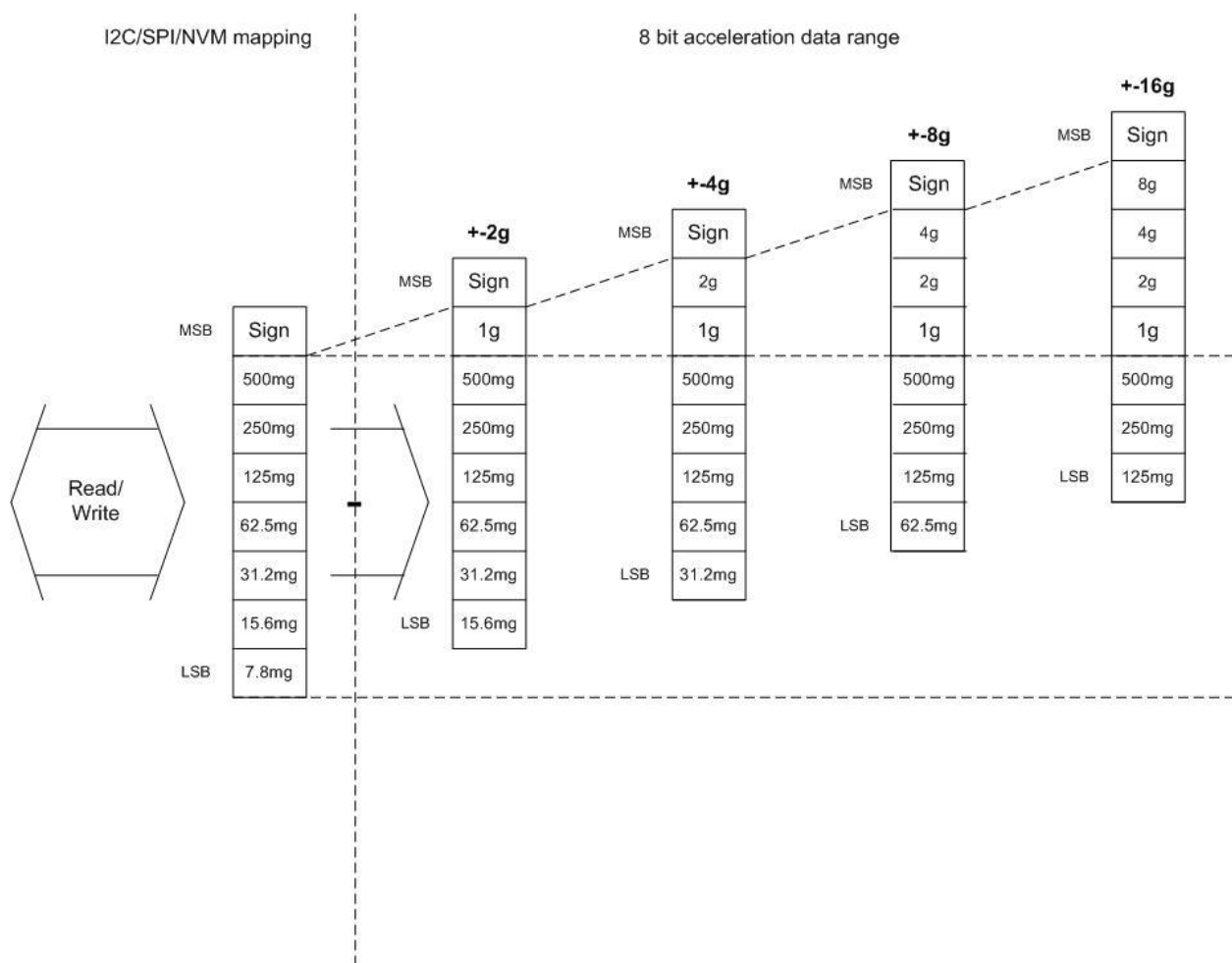



Figure 5: Principle of offset compensation

 BOSCH	BMA223 Preliminary data sheet	Page 22 Confidential
--	---	-------------------------

The public offset compensation registers (*0x38*) *offset_x*, (*0x39*) *offset_y*, (*0x3A*) *offset_z* are images of the corresponding registers in the NVM. With each image update (see section 4.6 Non-volatile memory for details) the contents of the NVM registers are written to the public registers. The public registers can be over-written by the user at any time.

Figure 5 illustrates how the offset compensation value scales with the range setting. The scaled offset compensation value is subsequently subtracted from the raw acceleration value.

By writing '1' to the (*0x36*) *offset_reset* bit, all offset compensation registers are reset to zero.

 BOSCH	BMA223 Preliminary data sheet	Page 23 Confidential
--	---	-------------------------

4.5.1 Slow compensation

Slow compensation is based on a 1st order high-pass filter, which continuously drives the average value of the output data stream of each axis to zero. The bandwidth of the high-pass filter is configured with bit $(0x37)$ *cut_off* according to Table 7.

Table 7: Compensation period settings

$(0x37)$ <i>cut_off</i>	high-pass filter bandwidth
0b	1
1b	10 Hz

The slow compensation can be enabled (disabled) for each axis independently by setting the bits $(0x36)$ *hp_x_en*, *hp_y_en*, *hp_z_en* to '1' ('0'), respectively.

Slow compensation should not be used in combination with low-power mode. In low-power mode the conditions (availability of necessary data) for proper function of slow compensation are not fulfilled.

4.5.2 Fast compensation

Fast compensation is a one-shot process by which the compensation value is set in such a way that when added to the raw acceleration, the resulting acceleration value of each axis approaches the target value. This is best suited for "end-of-line trimming" with the customer's device positioned in a well-defined orientation. For fast compensation the g-range has to be switched to 2g.

The algorithm in detail: An average of 16 consecutive acceleration values is computed and the difference between target value and computed value is written to $(0x38, 0x39, 0x3A)$ *offset_filt_x/y/z*. The public registers $(0x38, 0x39, 0x3A)$ *offset_filt_x/y/z* are updated with the contents of the internal registers (using saturation if necessary) and can be read by the user.

Fast compensation is triggered for each axis individually by setting the $(0x36)$ *cal_trigger* bits as shown in Table 8:

Table 8: Fast compensation axis selection

$(0x36)$ <i>cal_trigger</i>	Selected Axis
00b	none
01b	x
10b	y
11b	z

Register $(0x36)$ *cal_trigger* is a write-only register. Once triggered, the status of the fast correction process is reflected in the status bit $(0x36)$ *cal_rdy*. Bit $(0x36)$ *cal_rdy* is '0' while the correction is in progress. Otherwise it is '1'. Bit $(0x36)$ *cal_rdy* is '0' when $(0x36)$ *cal_trigger* is not '00'.

 BOSCH	BMA223 Preliminary data sheet	Page 24 Confidential
--	---	-------------------------

For the fast offset compensation, the compensation target can be chosen by setting the bits $(0x37)$ *offset_target_x*, $(0x37)$ *offset_target_y*, and $(0x37)$ *offset_target_z* according to Table 9:

Table 9: Offset target settings

$(0x37)$ <i>offset_target_x/y/z</i>	Target value
00b	0g
01b	+1g
10b	-1g
11b	0g

Fast compensation should not be used in combination with any of the low-power modes. In low-power mode the conditions (availability of necessary data) for proper function of fast compensation are not fulfilled.

4.5.3 Manual compensation

The contents of the public compensation registers $(0x38, 0x39, 0x3A)$ *offset_filt_x/y/z* can be set manually via the digital interface. It is recommended to write into these registers directly after a new data interrupt has occurred in order not to disturb running offset computations.

Writing to the offset compensation registers is not allowed while the fast compensation procedure is running.

4.5.4 Inline calibration

For certain applications, it is often desirable to calibrate the offset once and to store the compensation values permanently. This can be achieved by using one of the aforementioned offset compensation methods to determine the proper compensation values and then storing these values permanently in the NVM. See section 4.6 Non-volatile memory for details of the storing procedure.

Each time the device is reset, the compensation values are loaded from the non-volatile memory into the image registers and used for offset compensation until they are possibly overwritten using one of the other compensation methods.

 BOSCH	BMA223 Preliminary data sheet	Page 25 Confidential
--	---	-------------------------

4.6 Non-volatile memory

The entire memory of the BMA223 consists of three different kinds of registers: hard-wired, volatile, and non-volatile. Part of it can be both read and written by the user. Access to non-volatile memory is only possible through (volatile) image registers.

Altogether, there are eight registers (octets) with NVM backup which are accessible by the user. The addresses of the image registers range from 0x38 to 0x3C. While the addresses up to 0x3A are used for offset compensation (see 4.4 Offset Compensation), addresses 0x3B and 0x3C are general purpose registers not linked to any sensor-specific functionality.

The content of the NVM is loaded to the image registers after a reset (either POR or softreset) or after a user request which is performed by writing '1' to the write-only bit (0x33) *nvm_load*. As long as the image update is in progress, bit (0x33) *nvm_rdy* is '0', otherwise it is '1'.

The image registers can be read and written like any other register.

Writing to the NVM is a three-step procedure:

1. Write the new contents to the image registers.
2. Write '1' to bit (0x33) *nvm_prog_mode* in order to unlock the NVM.
3. Write '1' to bit (0x33) *nvm_prog_trig* and keep '1' in bit (0x33) *nvm_prog_mode* in order to trigger the write process.

Writing to the NVM always renews the entire NVM contents. It is possible to check the write status by reading bit (0x33) *nvm_rdy*. While (0x33) *nvm_rdy* = '0', the write process is still in progress; if (0x33) *nvm_rdy* = '1', then writing is completed. As long as the write process is ongoing, no change of power mode and image registers is allowed. Also, the NVM write cycle must not be initiated while image registers are updated, in low-power mode, and in suspend mode.

Please note that the number of permitted NVM write-cycles is limited as specified in Table 1. The number of remaining write-cycles can be obtained by reading bits (0x33) *nvm_remain*.

 BOSCH	BMA223 Preliminary data sheet	Page 26 Confidential
--	---	-------------------------

4.7 Interrupt controller

The BMA223 is equipped with eight programmable interrupt engines. Each interrupt can be independently enabled and configured. If the trigger condition of an enabled interrupt is fulfilled, the corresponding status bit is set to '1' and the selected interrupt pin is activated. The BMA223 provides two interrupt pins, INT1 and INT2; interrupts can be freely mapped to any of these pins. The state of a specific interrupt pin is derived from a logic 'or' combination of all interrupts mapped to it.

The interrupt status registers are updated when a new data word is written into the acceleration data registers. If an interrupt is disabled, all active status bits associated with it are immediately reset.

4.7.1 General features

An interrupt is cleared depending on the selected interrupt mode, which is common to all interrupts. There are three different interrupt modes: non-latched, latched, and temporary. The mode is selected by the (0x21) *latch_int* bits according to Table 10.

Table 10: Interrupt mode selection

(0x21) <i>latch_int</i>	Interrupt mode
0000b	non-latched
0001b	temporary, 250ms
0010b	temporary, 500ms
0011b	temporary, 1s
0100b	temporary, 2s
0101b	temporary, 4s
0110b	temporary, 8s
0111b	latched
1000b	non-latched
1001b	temporary, 250µs
1010b	temporary, 500µs
1011b	temporary, 1ms
1100b	temporary, 12.5ms
1101b	temporary, 25ms
1110b	temporary, 50ms
1111b	latched

An interrupt is generated if its activation condition is met. It can not be cleared as long as the activation condition is fulfilled. In the non-latched mode the interrupt status bit and the selected pin (the contribution to the 'or' condition for INT1 and/or INT2) are cleared as soon as the activation condition is no more valid. Exceptions to this behavior are the new data, orientation, and flat interrupts, which are automatically reset after a fixed time.

 BOSCH	BMA223 Preliminary data sheet	Page 27 Confidential
--	---	-------------------------

In latched mode an asserted interrupt status and the selected pin are cleared by writing '1' to bit ($0x21$) *reset_int*. If the activation condition still holds when it is cleared, the interrupt status is asserted again with the next change of the acceleration registers.

In the temporary mode an asserted interrupt and selected pin are cleared after a defined period of time. The behaviour of the different interrupt modes is shown graphically in figure 6. The timings in this mode are subject to the same tolerances as the bandwidths (see Table 1).

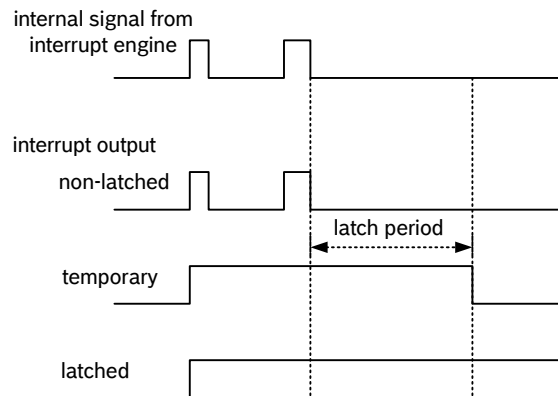

Figure 6: Interrupt modes

Several interrupt engines can use either unfiltered or filtered acceleration data as their input. For these interrupts, the source can be selected with the bits in register ($0x1E$). These are ($0x1E$) *int_src_data*, ($0x1E$) *int_src_tap*, ($0x1E$) *int_src_slo_no_mot*, ($0x1E$) *int_src_slope*, ($0x1E$) *int_src_high*, and ($0x1E$) *int_src_low*. Setting the respective bits to '0' ('1') selects filtered (unfiltered) data as input. The orientation recognition and flat detection interrupt always use filtered input data.

It is strongly recommended to set interrupt parameters prior to enabling the interrupt. Changing parameters of an already enabled interrupt may cause unwanted interrupt generation and generation of a false interrupt history. A safe way to change parameters of an enabled interrupt is to keep the following sequence: disable the desired interrupt, change parameters, wait for at least 10ms, and then re-enable the desired interrupt.

4.7.2 Mapping to physical interrupt pins (inttype to INT Pin#)

Registers ($0x19$) to ($0x1B$) are dedicated to mapping of interrupts to the interrupt pins "INT1" or "INT2". Setting ($0x19$) *int1_*"inttype" to '1' ('0') maps (unmaps) "inttype" to pin "INT1". Correspondingly setting ($0x1B$) *int2_*"inttype" to '1' ('0') maps (unmaps) "inttype" to pin "INT2".

Note: "inttype" to be replaced with the precise notation, given in the memory map in chapter 6.

Example: For flat interrupt (*int1_flat*): Setting ($0x19$) *int1_flat* to '1' maps *int1_flat* to pin "INT1".

 BOSCH	BMA223 Preliminary data sheet	Page 28 Confidential
--	---	-------------------------

4.7.3 Electrical behaviour (INT pin# to open-drive or push-pull)

Both interrupt pins can be configured to show the desired electrical behaviour. The 'active' level of each interrupt pin is determined by the $(0x20)$ *int1_lvl* and $(0x20)$ *int2_lvl* bits.

If $(0x20)$ *int1_lvl* = '1' ('0') / $(0x20)$ *int2_lvl* = '1' ('0'), then pin "INT1" / pin "INT2" is active '1' ('0'). The characteristic of the output driver of the interrupt pins may be configured with bits $(0x20)$ *int1_od* and $(0x20)$ *int2_od*. By setting bits $(0x20)$ *int1_od* / $(0x20)$ *int2_od* to '1', the output driver shows open-drive characteristic, by setting the configuration bits to '0', the output driver shows push-pull characteristic.

4.7.4 New data interrupt

This interrupt serves for synchronous reading of acceleration data. It is generated after storing a new value of z-axis acceleration data in the data register. The interrupt is cleared automatically when the next data acquisition cycle starts. The interrupt status is '0' for at least 50µs.

The interrupt mode of the new data interrupt is fixed to non-latched.

It is enabled (disabled) by writing '1' ('0') to bit $(0x17)$ *data_en*. The interrupt status is stored in bit $(0x0A)$ *data_int*.

Due to the settling time of the filter, the first interrupt after wake-up from suspend or standby mode will take longer than the update time.

 BOSCH	BMA223 Preliminary data sheet	Page 29 Confidential
--	---	-------------------------

4.7.5 Slope / any-motion detection

Slope / any-motion detection uses the slope between successive acceleration signals to detect changes in motion. An interrupt is generated when the slope (absolute value of acceleration difference) exceeds a preset threshold. It is cleared as soon as the slope falls below the threshold. The principle is made clear in figure 7.

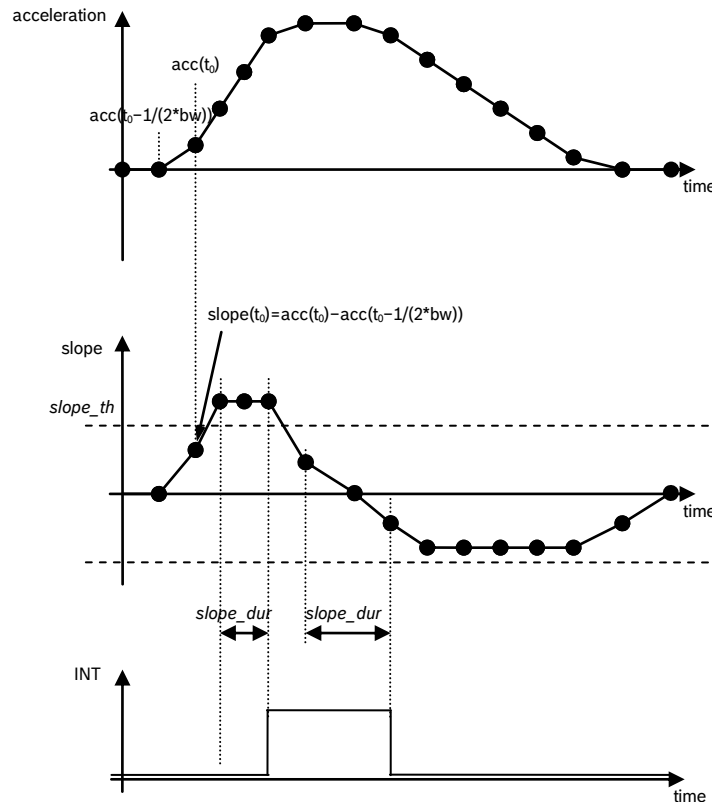



Figure 7: Principle of any-motion detection

The threshold is defined through register (0x28) *slope_th*. In terms of scaling 1 LSB of (0x28) *slope_th* corresponds to 15.6mg in 2g-range (31.3mg in 4g-range, 62.5mg in 8g-range and 125mg in 16g-range).

The time difference between the successive acceleration signals depends on the selected bandwidth and equates to $1/(2 \cdot \text{bandwidth})$ ($t = 1/(2 \cdot bw)$). In order to suppress false triggers, the interrupt is only generated (cleared) if a certain number N of consecutive slope data points is larger (smaller) than the slope threshold given by (0x28) *slope_th*. This number is set by the (0x27) *slope_dur* bits. It is $N = (0x27) \text{ slope_dur} + 1$ for (0x27).

Example: (0x27) *slope_dur* = 00b, ..., 11b = 1decimal, ..., 4decimal.

 BOSCH	BMA223 Preliminary data sheet	Page 30 Confidential
--	---	-------------------------

4.7.5.1 Enabling (disabling) for each axis

Any-motion detection can be enabled (disabled) for each axis separately by writing '1' ('0') to bits (0x16) *slope_en_x*, (0x16) *slope_en_y*, (0x16) *slope_en_z*. The criteria for any-motion detection are fulfilled and the slope interrupt is generated if the slope of any of the enabled axes exceeds the threshold (0x28) *slope_th* for [(0x27) *slope_dur* +1] consecutive times. As soon as the slopes of all enabled axes fall or stay below this threshold for [(0x27) *slope_dur* +1] consecutive times the interrupt is cleared unless interrupt signal is latched.

4.7.5.2 Axis and sign information of slope / any motion interrupt

The interrupt status is stored in bit (0x09) *slope_int*. The any-motion interrupt supplies additional information about the detected slope. The axis which triggered the interrupt is given by that one of bits (0x0B) *slope_first_x*, (0x0B) *slope_first_y*, (0x0B) *slope_first_z* that contains a value of '1'. The sign of the triggering slope is held in bit (0x0B) *slope_sign* until the interrupt is retriggered. If (0x0B) *slope_sign* = '0' ('1'), the sign is positive (negative).

 BOSCH	BMA223 Preliminary data sheet	Page 31 Confidential
--	---	-------------------------

4.7.6 Tap sensing

Tap sensing has a functional similarity with a common laptop touch-pad or clicking keys of a computer mouse. A tap event is detected if a pre-defined slope of the acceleration of at least one axis is exceeded. Two different tap events are distinguished: A 'single tap' is a single event within a certain time, followed by a certain quiet time. A 'double tap' consists of a first such event followed by a second event within a defined time frame.

Single tap interrupt is enabled (disabled) by writing '1' ('0') to bit (0x16) *s_tap_en*. Double tap interrupt is enabled (disabled) by writing '1' ('0') to bit (0x16) *d_tap_en*.

The status of the single tap interrupt is stored in bit (0x09) *s_tap_int*, the status of the double tap interrupt is stored in bit (0x09) *d_tap_int*.

The slope threshold for detecting a tap event is set by bits (0x2B) *tap_th*. The meaning of (0x2B) *tap_th* depends on the range setting. 1 LSB of (0x2B) *tap_th* corresponds to a slope of 62.5mg in 2g-range, 125mg in 4g-range, 250mg in 8g-range, and 500mg in 16g-range.

In figure 8 the meaning of the different timing parameters is visualized:

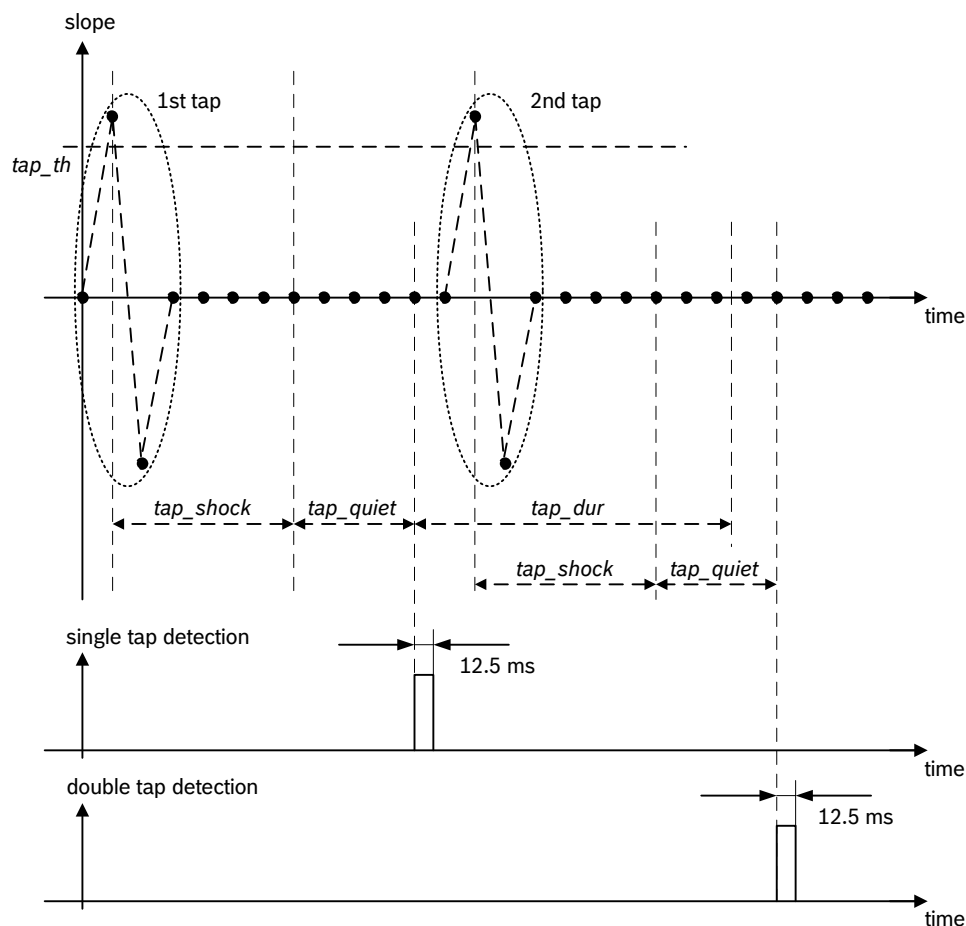



Figure 8: Timing of tap detection

 BOSCH	BMA223 Preliminary data sheet	Page 32 Confidential
--	---	-------------------------

The parameters $(0x2A)$ *tap_shock* and $(0x2A)$ *tap_quiet* apply to both single tap and double tap detection, while $(0x2A)$ *tap_dur* applies to double tap detection only. Within the duration of $(0x2A)$ *tap_shock* any slope exceeding $(0x2B)$ *tap_th* after the first event is ignored. Contrary to this, within the duration of $(0x2A)$ *tap_quiet* no slope exceeding $(0x2B)$ *tap_th* must occur, otherwise the first event will be cancelled.

4.7.6.1 Single tap detection

A single tap is detected and the single tap interrupt is generated after the combined durations of $(0x2A)$ *tap_shock* and $(0x2A)$ *tap_quiet*, if the corresponding slope conditions are fulfilled. The interrupt is cleared after a delay of 12.5 ms.

4.7.6.2 Double tap detection

A double tap interrupt is generated if an event fulfilling the conditions for a single tap occurs within the set duration in $(0x2A)$ *tap_dur* after the completion of the first tap event. The interrupt is automatically cleared after a delay of 12.5 ms.

4.7.6.3 Selecting the timing of tap detection

For each of parameters $(0x2A)$ *tap_shock* and $(0x2A)$ *tap_quiet* two values are selectable. By writing '0' ('1') to bit $(0x2A)$ *tap_shock* the duration of $(0x2A)$ *tap_shock* is set to 50 ms (75 ms). By writing '0' ('1') to bit $(0x2A)$ *tap_quiet* the duration of $(0x2A)$ *tap_quiet* is set to 30 ms (20 ms).

The length of $(0x2A)$ *tap_dur* can be selected by setting the $(0x2A)$ *tap_dur* bits according to Table 11:

Table 11: Selection of *tap_dur*

$(0x2A)$ <i>tap_dur</i>	length of <i>tap_dur</i>
000b	50 ms
001b	100 ms
010b	150 ms
011b	200 ms
100b	250 ms
101b	375 ms
110b	500 ms
111b	700 ms

 BOSCH	BMA223 Preliminary data sheet	Page 33 Confidential
--	---	-------------------------

4.7.6.4 Axis and sign information of tap sensing

The sign of the slope of the first tap which triggered the interrupt is stored in bit $(0x0B)$ *tap_sign* ('0' means positive sign, '1' means negative sign). The value of this bit persists after clearing the interrupt.

The axis which triggered the interrupt is indicated by bits $(0x0B)$ *tap_first_x*, $(0x0B)$ *tap_first_y*, and $(0x0B)$ *tap_first_z*.

The bit corresponding to the triggering axis contains a '1' while the other bits hold a '0'. These bits are cleared together with clearing the interrupt status.

4.7.6.5 Tap sensing in low power mode

In low-power mode, a limited number of samples is processed after wake-up to decide whether an interrupt condition is fulfilled. The number of samples is selected by bits $(0x2B)$ *tap_samp* according to Table 12.

Table 12: Meaning of $(0x2B)$ *tap_samp*

$(0x2B)$ <i>tap_samp</i>	Number of Samples
00b	2
01b	4
10b	8
11b	16

 BOSCH	BMA223 Preliminary data sheet	Page 34 Confidential
--	---	-------------------------

4.7.7 Orientation recognition

The orientation recognition feature informs on an orientation change of the sensor with respect to the gravitational field vector 'g'. The measured acceleration vector components with respect to the gravitational field are defined as shown in figure 9.

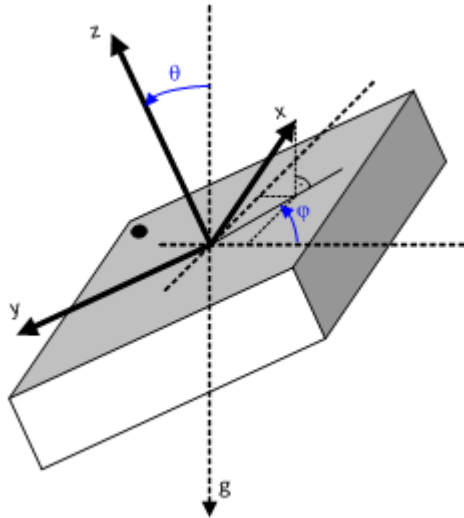

Figure 9: Definition of vector components

Therefore, the magnitudes of the acceleration vectors are calculated as follows:

$$\begin{aligned}
 \text{acc_x} &= 1g \times \sin\theta \times \cos\phi \\
 \text{acc_y} &= -1g \times \sin\theta \times \sin\phi \\
 \text{acc_z} &= 1g \times \cos\theta \\
 \text{acc_y/acc_x} &= -\tan\phi
 \end{aligned}$$

Depending on the magnitudes of the acceleration vectors the orientation of the device in the space is determined and stored in the three (0x0C) *orient* bits. These bits may not be reset in the sleep phase of low-power mode. There are three orientation calculation modes with different thresholds for switching between different orientations: symmetrical, high-asymmetrical, and low-asymmetrical. The mode is selected by setting the (0x2C) *orient_mode* bits as given in Table 13.

Table 13: Orientation mode settings

(0x2C) <i>orient_mode</i>	Orientation Mode
00b	symmetrical
01b	high-asymmetrical
10b	low-asymmetrical
11b	symmetrical

 BOSCH	BMA223 Preliminary data sheet	Page 35 Confidential
--	---	-------------------------

For each orientation mode the (0x0C) *orient* bits have a different meaning as shown in Table 14 to Table 16:

Table 14: Meaning of the (0x0C) *orient* bits in symmetrical mode

(0x0C) <i>orient</i>	Name	Angle	Condition
x00	portrait upright	$315^\circ < \varphi < 45^\circ$	$ acc_y < acc_x - 'hyst'$ and $acc_x - 'hyst' \geq 0$
x01	portrait upside down	$135^\circ < \varphi < 225^\circ$	$ acc_y < acc_x - 'hyst'$ and $acc_x + 'hyst' < 0$
x10	landscape left	$45^\circ < \varphi < 135^\circ$	$ acc_y \geq acc_x + 'hyst'$ and $acc_y < 0$
x11	landscape right	$225^\circ < \varphi < 315^\circ$	$ acc_y \geq acc_x + 'hyst'$ and $acc_y \geq 0$

Table 15: Meaning of the (0x0C) *orient* bits in high-asymmetrical mode

(0x0C) <i>orient</i>	Name	Angle	Condition
x00	portrait upright	$297^\circ < \varphi < 63^\circ$	$ acc_y < 2 \cdot acc_x - 'hyst'$ and $acc_x - 'hyst' \geq 0$
x01	portrait upside down	$117^\circ < \varphi < 243^\circ$	$ acc_y < 2 \cdot acc_x - 'hyst'$ and $acc_x + 'hyst' < 0$
x10	landscape left	$63^\circ < \varphi < 117^\circ$	$ acc_y \geq 2 \cdot acc_x + 'hyst'$ and $acc_y < 0$
x11	landscape right	$243^\circ < \varphi < 297^\circ$	$ acc_y \geq 2 \cdot acc_x + 'hyst'$ and $acc_y \geq 0$

Table 16: Meaning of the (0x0C) *orient* bits in low-asymmetrical mode

(0x0C) <i>orient</i>	Name	Angle	Condition
x00	portrait upright	$333^\circ < \varphi < 27^\circ$	$ acc_y < 0.5 \cdot acc_x - 'hyst'$ and $acc_x - 'hyst' \geq 0$
x01	portrait upside down	$153^\circ < \varphi < 207^\circ$	$ acc_y < 0.5 \cdot acc_x - 'hyst'$ and $acc_x + 'hyst' < 0$
x10	landscape left	$27^\circ < \varphi < 153^\circ$	$ acc_y \geq 0.5 \cdot acc_x + 'hyst'$ and $acc_y < 0$
x11	landscape right	$207^\circ < \varphi < 333^\circ$	$ acc_y \geq 0.5 \cdot acc_x + 'hyst'$ and $acc_y \geq 0$

In the preceding tables, the parameter 'hyst' stands for a hysteresis, which can be selected by setting the (0x2C) *orient_hyst* bits. 1 LSB of (0x2C) *orient_hyst* always corresponds to 62.5 mg, in any g-range (i.e. increment is independent from g-range setting). It is important to note that by using a hysteresis $\neq 0$ the actual switching angles become different from the angles given in the tables since there is an overlap between the different orientations.

The most significant bit of the (0x0C) *orient* bits (which is displayed as an 'x' in the above given tables) contains information about the direction of the z-axis. It is set to '0' ('1') if $acc_z \geq 0$ ($acc_z < 0$).

 BOSCH	BMA223 Preliminary data sheet	Page 36 Confidential
--	---	-------------------------

Figure 10 shows the typical switching conditions between the four different orientations for the symmetrical mode i.e. without hysteresis:

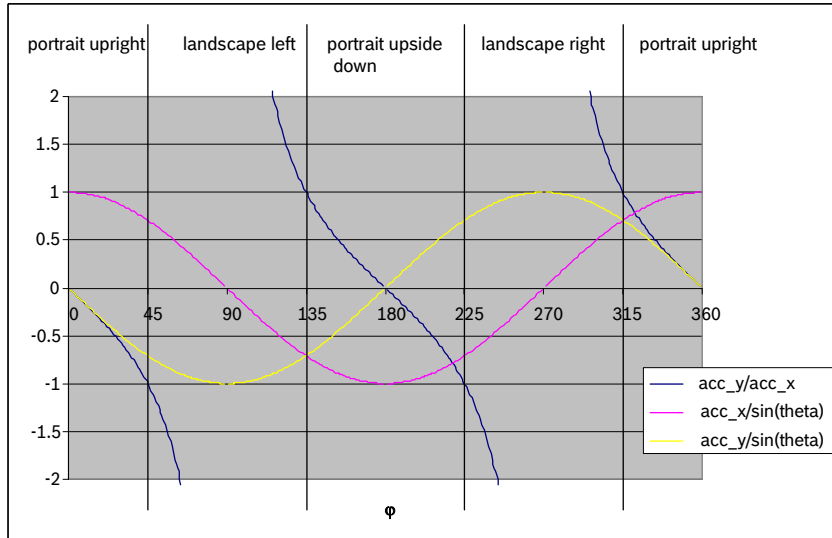



Figure 10: Typical orientation switching conditions w/o hysteresis

The orientation interrupt is enabled (disabled) by writing '1' ('0') to bit (0x16) *orient_en*. The interrupt is generated if the value of (0x0C) *orient* has changed. It is automatically cleared after one stable period of the (0x0C) *orient* value. The interrupt status is stored in the (0x09) *orient_int* bit. The register (0x0C) *orient* always reflects the current orientation of the device, irrespective of which interrupt mode has been selected. Bit (0x0C) *orient*<2> reflects the device orientation with respect to the z-axis. The bits (0x0C) *orient*<1:0> reflect the device orientation in the x-y-plane. The conventions associated with register (0x0C) *orient* are detailed in chapter 6.

 BOSCH	BMA223 Preliminary data sheet	Page 37 Confidential
--	---	-------------------------

4.7.7.1 Orientation blocking

The change of the (0x0C) *orient* value and – as a consequence – the generation of the interrupt can be blocked according to conditions selected by setting the value of the (0x2C) *orient_blocking* bits as described by Table 17

Table 17: Blocking conditions for orientation recognition

(0x2C) <i>orient_blocking</i>	Conditions
00b	no blocking
01b	theta blocking or acceleration in any axis > 1.5g
10b	theta blocking or acceleration slope in any axis > 0.2 g or acceleration in any axis > 1.5g
11b	theta blocking or acceleration slope in any axis > 0.4 g or acceleration in any axis > 1.5g and value of orient is not stable for at least 100 ms

The theta blocking is defined by the following inequality:

$$|\tan \theta| < \frac{\sqrt{\text{blocking_theta}}}{8}$$

The parameter *blocking_theta* of the above given equation stands for the contents of the (0x2D) *orient_theta* bits. It is possible to define a blocking angle between 0° and 44.8°. The internal blocking algorithm saturates the acceleration values before further processing. As a consequence, the blocking angles are strictly valid only for a device at rest; they can be different if the device is moved.

Example:

To get a maximum blocking angle of 19° the parameter *blocking_theta* is determined in the following way: $(8 * \tan(19^\circ))^2 = 7.588$, therefore, *blocking_value* = 8dec = 001000b has to be chosen.

In order to avoid unwanted generation of the orientation interrupt in a nearly flat position ($z \sim 0$, sign change due to small movements or noise), a hysteresis of 0.2 g is implemented for the z-axis, i. e. a after a sign change the interrupt is only generated after $|z| > 0.2$ g.

4.7.7.2 Up-Down Interrupt Suppression Flag

Per default an orientation interrupt is triggered when any of the bits in register (0x0C) *orient*

 BOSCH	BMA223 Preliminary data sheet	Page 38 Confidential
--	---	-------------------------

changes state. The BMA223 can be configured to trigger orientation interrupts only when the device position changes in the x-y-plane while orientation changes with respect to the z-axis are ignored. A change of the orientation of the z-axis, and hence a state change of bit (0x0C) *orient<2>* is ignored (considered) when bit (0x2D) *orient_ud_en* is set to '0' ('1').

 BOSCH	BMA223 Preliminary data sheet	Page 39 Confidential
--	---	-------------------------

4.7.8 Flat detection

The flat detection feature gives information about the orientation of the devices' z-axis relative to the g-vector, i. e. it recognizes whether the device is in a flat position or not.

The flat angle Θ is adjustable by $(0x2E)$ *flat_theta* from 0° to 44.8°. The flat angle can be set according to following formula:

$$\Theta = \text{atan}\left(\frac{1}{8}\sqrt{\text{flat_theta}}\right)$$

A hysteresis of the flat detection can be enabled by $(0x2F)$ *flat_hy* bits. In this case the flat position is set if the angle drops below following threshold:

$$\Theta_{\text{hyst, ll}} = \text{atan}\left(\frac{1}{8}\sqrt{\text{flat_theta} \cdot \left(1 - \frac{\text{flat_hy}}{1024}\right) - \frac{\text{flat_hy}}{16}}\right)$$

The flat position is reset if the angle exceeds the following threshold:

$$\Theta_{\text{hyst, ul}} = \text{atan}\left(\frac{1}{8}\sqrt{\text{flat_theta} \cdot \left(1 + \frac{\text{flat_hy}}{1024}\right) + \frac{\text{flat_hy}}{16}}\right)$$

The flat interrupt is enabled (disabled) by writing '1' ('0') to bit $(0x16)$ *flat_en*. The flat value is stored in the $(0x0C)$ *flat* bit if the interrupt is enabled. This value is '1' if the device is in the flat position, it is '0' otherwise. The flat interrupt is generated if the flat value has changed and the new value is stable for at least the time given by the $(0x2F)$ *flat_hold_time* bits. A flat interrupt may be also generated if the flat interrupt is enabled. The actual status of the interrupt is stored in the $(0x09)$ *flat_int* bit. The flat orientation of the sensor can always be determined from reading the $(0x0C)$ *flat* bit after interrupt generation. If unlatched interrupt mode is used, the $(0x09)$ *flat_int* value and hence the interrupt is automatically cleared after one sample period. If temporary or latched interrupt mode is used, the $(0x09)$ *flat_int* value is kept fixed until the latch time expires or the interrupt is reset.

The meaning of the $(0x2F)$ *flat_hold_time* bits can be seen from Table 18.

Table 18: Meaning of *flat_hold_time*

$(0x2F)$ <i>flat_hold_time</i>	Time
00b	0
01b	512 ms
10b	1024 ms
11b	2048 ms

 BOSCH	BMA223 Preliminary data sheet	Page 40 Confidential
--	---	-------------------------

4.7.9 Low-g interrupt

This interrupt is based on the comparison of acceleration data against a low-g threshold, which is most useful for free-fall detection.

The interrupt is enabled (disabled) by writing '1' ('0') to the (0x17) *low_en* bit. There are two modes available, 'single' mode and 'sum' mode. In 'single' mode, the acceleration of each axis is compared with the threshold; in 'sum' mode, the sum of absolute values of all accelerations $|acc_x| + |acc_y| + |acc_z|$ is compared with the threshold. The mode is selected by the contents of the (0x24) *low_mode* bit: '0' means 'single' mode, '1' means 'sum' mode.

The low-g threshold is set through the (0x23) *low_th* register. 1 LSB of (0x23) *low_th* always corresponds to an acceleration of 7.81 mg (i.e. increment is independent from g-range setting).

A hysteresis can be selected by setting the (0x24) *low_hy* bits. 1 LSB of (0x24) *low_hy* always corresponds to an acceleration difference of 125 mg in any g-range (as well, increment is independent from g-range setting).

The low-g interrupt is generated if the absolute values of the acceleration of all axes ('and' relation, in case of single mode) or their sum (in case of sum mode) are lower than the threshold for at least the time defined by the (0x22) *low_dur* register. The interrupt is reset if the absolute value of the acceleration of at least one axis ('or' relation, in case of single mode) or the sum of absolute values (in case of sum mode) is higher than the threshold plus the hysteresis for at least one data acquisition. In bit (0x09) *low_int* the interrupt status is stored.

The relation between the content of (0x22) *low_dur* and the actual delay of the interrupt generation is: $delay [ms] = [(0x22) low_dur + 1] \cdot 2$ ms. Therefore, possible delay times range from 2 ms to 512 ms.

 BOSCH	BMA223 Preliminary data sheet	Page 41 Confidential
--	---	-------------------------

4.7.10 High-g interrupt

This interrupt is based on the comparison of acceleration data against a high-g threshold for the detection of shock or other high-acceleration events.

The high-g interrupt is enabled (disabled) per axis by writing '1' ('0') to bits $(0x17)$ *high_en_x*, $(0x17)$ *high_en_y*, and $(0x17)$ *high_en_z*, respectively. The high-g threshold is set through the $(0x26)$ *high_th* register. The meaning of an LSB of $(0x26)$ *high_th* depends on the selected g-range: it corresponds to 7.81 mg in 2g-range, 15.63 mg in 4g-range, 31.25 mg in 8g-range, and 62.5 mg in 16g-range (i.e. increment depends from g-range setting).

A hysteresis can be selected by setting the $(0x24)$ *high_hy* bits. Analogously to $(0x26)$ *high_th*, the meaning of an LSB of $(0x24)$ *high_hy* is g-range dependent: It corresponds to an acceleration difference of 125 mg in 2g-range, 250 mg in 4g-range, 500 mg in 8g-range, and 1000mg in 16g-range (as well, increment depends from g-range setting).

The high-g interrupt is generated if the absolute value of the acceleration of at least one of the enabled axes ('or' relation) is higher than the threshold for at least the time defined by the $(0x25)$ *high_dur* register. The interrupt is reset if the absolute value of the acceleration of all enabled axes ('and' relation) is lower than the threshold minus the hysteresis for at least the time defined by the $(0x25)$ *high_dur* register. In bit $(0x09)$ *high_int* the interrupt status is stored. The relation between the content of $(0x25)$ *high_dur* and the actual delay of the interrupt generation is delay [ms] = $[(0x22)$ *low_dur* + 1] • 2 ms. Therefore, possible delay times range from 2 ms to 512 ms.

4.7.10.1 Axis and sign information of high-g interrupt

The axis which triggered the interrupt is indicated by bits $(0x0C)$ *high_first_x*, $(0x0C)$ *high_first_y*, and $(0x0C)$ *high_first_z*. The bit corresponding to the triggering axis contains a '1' while the other bits hold a '0'. These bits are cleared together with clearing the interrupt status. The sign of the triggering acceleration is stored in bit $(0x0C)$ *high_sign*. If $(0x0C)$ *high_sign* = '0' ('1'), the sign is positive (negative).

 BOSCH	BMA223 Preliminary data sheet	Page 42 Confidential
--	---	-------------------------

4.7.11 No-motion / slow motion detection

The slow-motion/no-motion interrupt engine can be configured in two modes.

In slow-motion mode an interrupt is triggered when the measured slope of at least one enabled axis exceeds the programmable slope threshold for a programmable number of samples. Hence the engine behaves similar to the any-motion interrupt, but with a different set of parameters. In order to suppress false triggers, the interrupt is only generated (cleared) if a certain number N of consecutive slope data points is larger (smaller) than the slope threshold given by $(0x27) slo_no_mot_dur<1:0>$. The number is $N = (0x27) slo_no_mot_dur<1:0> + 1$.

In no-motion mode an interrupt is generated if the slope on all selected axes remains smaller than a programmable threshold for a programmable delay time. Figure 11 shows the timing diagram for the no-motion interrupt. The scaling of the threshold value is identical to that of the slow-motion interrupt. However, in no-motion mode register $(0x27) slo_no_mot_dur$ defines the delay time before the no-motion interrupt is triggered. Table 19 lists the delay times adjustable with register $(0x27) slo_no_mot_dur$. The timer tick period is 1 second. Hence using short delay times can result in considerable timing uncertainty.

If bit $(0x18) slo_no_mot_sel$ is set to '1' ('0') the no-motion/slow-motion interrupt engine is configured in the no-motion (slow-motion) mode. Common to both modes, the engine monitors the slopes of the axes that have been enabled with bits $(0x18) slo_no_mot_en_x$, $(0x18) slo_no_mot_en_y$, and $(0x18) slo_no_mot_en_z$ for the x-axis, y-axis and z-axis, respectively. The measured slope values are continuously compared against the threshold value defined in register $(0x29) slo_no_mot_th$. The scaling is such that 1 LSB of $(0x29) slo_no_mot_th$ corresponds to 3.91 mg in 2g-range (7.81 mg in 4g-range, 15.6 mg in 8g-range and 31.3 mg in 16g-range). Therefore the maximum value is 996 mg in 2g-range (1.99g in 4g-range, 3.98g in 8g-range and 7.97g in 16g-range). The time difference between the successive acceleration samples depends on the selected bandwidth and equates to $1/(2 * bw)$.

Table 19: No-motion time-out periods

$(0x27)$ $slo_no_mot_dur$	Delay time	$(0x27)$ $slo_no_mot_dur$	Delay time	$(0x27)$ $slo_no_mot_dur$	Delay Time
0	1 s	16	40 s	32	88 s
1	2 s	17	48 s	33	96 s
2	3 s	18	56 s	34	104 s
...	...	19	64 s
14	15 s	20	72 s	62	328 s
15	16 s	21	80 s	63	336 s

Note: $slo_no_mot_dur$ values 22 to 31 are not specified

 BOSCH	BMA223 Preliminary data sheet	Page 43 Confidential
--	---	-------------------------

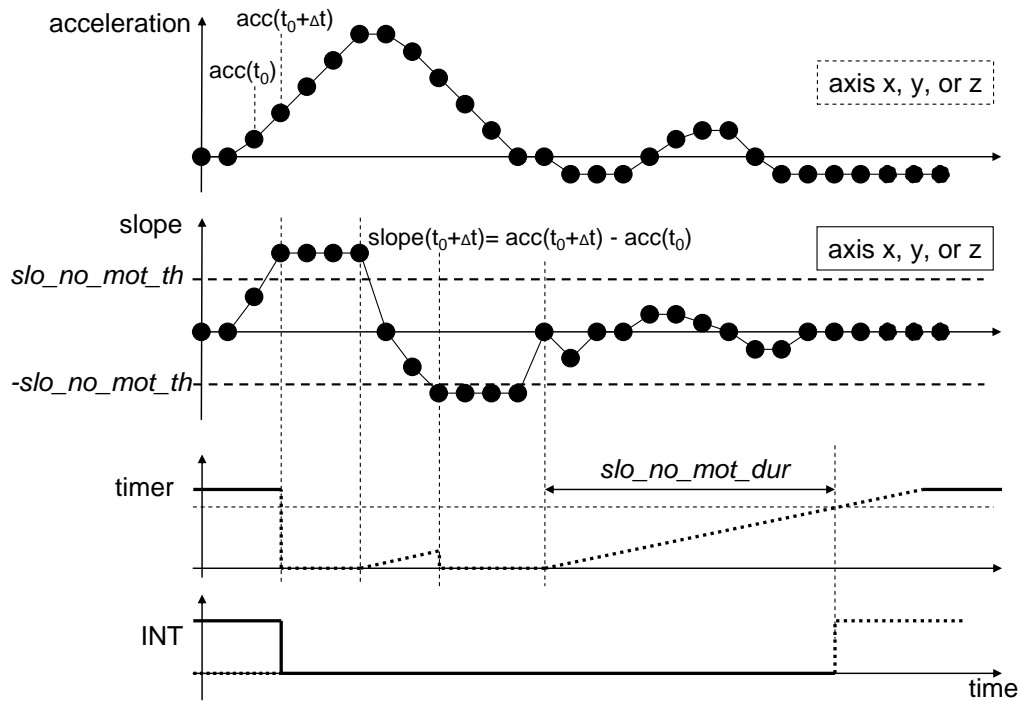



Figure 11: Timing of No-motion interrupt

 BOSCH	BMA223 Preliminary data sheet	Page 44 Confidential
--	---	-------------------------

4.8 Softreset

A softreset causes all user configuration settings to be overwritten with their default value and the sensor to enter normal mode.

A softreset is initiated by means of writing value 0xB6 to register (0x14) *softreset*. Subsequently a waiting time of $t_{w,up1}$ (max.) is required prior to accessing any configuration registers.

 BOSCH	BMA223 Preliminary data sheet	Page 45 Confidential
--	---	-------------------------

5. FIFO Operation

5.1 FIFO Operating Modes

The BMA223 features an integrated FIFO memory capable of storing up to 32 frames. Conceptually each frame consists of three 16 bit words corresponding to the x, y and z- axis, which are sampled at the same point in time. At the core of the FIFO is a buffer memory, which can be configured to operate in the following modes:

- **FIFO Mode:** In FIFO mode the acceleration data of the selected axes are stored in the buffer memory. If enabled, a watermark interrupt is triggered when the buffer has filled up to a configurable level. The buffer will be continuously filled until the fill level reaches 32 frames. When it is full the data collection is stopped, and all additional samples are ignored. Once the buffer is full, a FIFO-full interrupt is generated if it has been enabled.
- **STREAM Mode:** In STREAM mode the acceleration data of the selected axes are stored in the buffer until it is full. The buffer has a depth of 31 frames. When the buffer is full the data collection continues and oldest entry is discarded. If enabled, a watermark interrupt is triggered when the buffer is filled to a configurable level. Once the buffer is full, a FIFO-full interrupt is generated if it has been enabled.
- **BYPASS Mode:** In bypass mode, only the current sensor data can be read out from the FIFO address. Essentially, the FIFO behaves like the STREAM mode with a depth of 1. Compared to reading the data from the normal data registers, the advantage to the user is that the packages X, Y, Z are from the same timestamp, while the data registers are updated sequentially and hence mixing of data from different axes can occur.

The primary FIFO operating mode is selected with register (0x3E) *fifo_mode* according to '00b' for BYPASS mode, '01b' for FIFO mode, and '10b' for STREAM mode. Writing to register (0x3E) clears the buffer content and resets the FIFO-full and watermark interrupts. When reading register (0x3E) *fifo_mode* always contains the current operating mode.

 BOSCH	BMA223 Preliminary data sheet	Page 46 Confidential
--	---	-------------------------

5.2 FIFO Data Readout

The FIFO stores the data that are also available at the acceleration read-out registers (0x02) to (0x07). Thus, all configuration settings apply to the FIFO data as well as the acceleration data readout registers. The FIFO read out is possible through register (0x3F). The readout can be performed using burst mode since the read address counter is no longer incremented, when it has reached address (0x3F). This implies that the trapping also occurs when the burst read access starts below address (0x3F). A single burst can read out one or more frames at a time. Register (0x3E) *fifo_data_select* controls the acceleration data of which axes are stored in the FIFO. Possible settings for register (0x3E) *fifo_data_select* are '00b' for x, y- and z-axis, '01b' for x-axis only, '10b' for y-axis, '11b' for z-axis only. The depth of the FIFO is independent of whether all or a single axis have been selected. Writing to register (0x3E) clears the buffer content and resets the FIFO-full and watermark interrupts.

If all axes are enabled, the format of the data read-out from register (0x3F) is as follows:

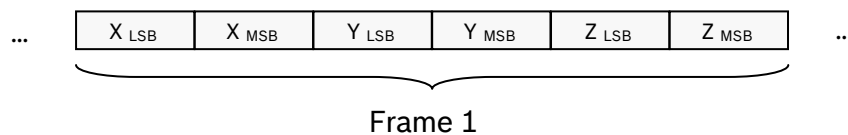

If only one axis is enabled, the format of the data read-out from register (0x3F) is as follows (example shown: y-axis only, other axes are equivalent).

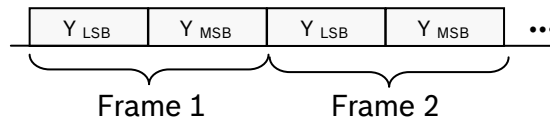

If a frame is not completely read due to an incomplete read operation, the remaining part of the frame is discarded. In this case the FIFO aligns to the next frame during the next read operation. In order for the discarding mechanism to operate correctly, there must be a delay of at least 1.5 us between the last data bit of the partially read frame and the first address bit of the next FIFO read access. Otherwise frames must not be read out partially.

If the FIFO is read beyond the FIFO fill level zeroes (0) will be read. If the FIFO is read beyond the FIFO fill level the read or burst read access time must not exceed the sampling time t_{SAMPLE} . Otherwise frames may be lost.

5.3 FIFO Frame Counter and Overrun Flag

Register (0x0E) *fifo_frame_counter* reflects the current fill level of the buffer. If additional frames are written to the buffer although the FIFO is full, the (0x0E) *fifo_overrun* bit is set to '1'. The FIFO buffer is cleared, the FIFO fill level indicated in register (0x0E) *fifo_frame_counter* and the (0x0E) *fifo_overrun* bit are both set to '0' each time one a write access to one of the FIFO configuration registers (0x3E) or (0x30) occurs. The (0x0E) *fifo_overrun* bit is not reset when the FIFO fill level (0x0E) *fifo_frame_counter* has decremented to '0' due to reading from register (0x3F).

 BOSCH	BMA223 Preliminary data sheet	Page 47 Confidential
--	---	-------------------------

5.4 FIFO Interrupts

The FIFO controller can generate two different interrupt events, a FIFO-full and a watermark event. The FIFO-full and watermark interrupts are functional in all FIFO operating modes. The watermark interrupt is asserted when the fill level in the buffer has reached the frame count defined by register (0x30) *fifo_water_mark_trigger_retain*. In order to enable (disable) the watermark interrupt, the (0x17) *int_fwm_en* bit must be set to '1' ('0'). To map the watermark interrupt signal to INT1 pin (INT2 pin), (0x1A) *int1_fwm* ((0x1A) *int2_fwm*) bit must be set to '1'. The status of the watermark interrupt may be read back through the (0x0A) *fifo_wm_int* bit. Writing to register (0x30) *fifo_water_mark_trigger_retain* clears the FIFO buffer.

The FIFO-full interrupt is triggered when the buffer has been completely filled. In FIFO mode this occurs 32, in STREAM mode 31 samples, and in BYPASS mode 1 sample after the buffer has been cleared. In order to enable the FIFO-full interrupt, bit (0x17) *int_fful_en* as well as one or both of bits (0x1A) *int1_fful* or (0x1A) *int2_fful* must also be set to '1'. The status of the FIFO-full interrupt may be read back through bit (0x0A) *fifo_full_int*.

 BOSCH	BMA223 Preliminary data sheet	Page 48 Confidential
--	---	-------------------------

6. Register description

6.1 General remarks

The entire communication with the device is performed by reading from and writing to registers. Registers have a width of 8 bits; they are mapped to a common space of 64 addresses from (0x00) up to (0x3F). Within the used range there are several registers which are either completely or partially marked as 'reserved'. Any reserved bit is ignored when it is written and no specific value is guaranteed when read. It is recommended not to use registers at all which are completely marked as 'reserved'. Furthermore it is recommended to mask out (logical *and* with zero) reserved bits of registers which are partially marked as reserved.

Registers with addresses from (0x00) up to (0x0E) are read-only. Any attempt to write to these registers is ignored. There are bits within some registers that trigger internal sequences. These bits are configured for write-only access, e. g. (0x21) *reset_int* or the entire (0x14) *softreset* register, and read as value '0'.

6.2 Register map

Register Address	bit7	bit6	bit5	bit4	bit3	bit2	bit1	bit0	Access	Default		
0x3F	fifo_data_output_register<7:0>								ro	0x00		
0x3E	fifo_mode<1:0>							fifo_data_select<1:0>		w/r	0x00	
0x3D									w/r	0xFF		
0x3C	GP1<7:0>								w/r	0x00		
0x3B	GP0<7:0>								w/r	0x00		
0x3A	offset_z<7:0>								w/r	0x00		
0x39	offset_y<7:0>								w/r	0x00		
0x38	offset_x<7:0>								w/r	0x00		
0x37	offset_target_z<1:0>			offset_target_y<1:0>		offset_target_x<1:0>		cut_off	w/r	0x00		
0x36	offset_reset	cal_trigger<1:0>		cal_rdy	hp_z_en		hp_y_en	hp_x_en	w/r	0x10		
0x35									w/r	0x00		
0x34									w/r	0x00		
0x33	nvm_remain<3:0>			nvm_load		i2c_wdt_en	i2c_wdt_sel	spi3	w/r	0x00		
0x32				self_test_amp	self_test_sign		self_test_axis<1:0>		w/r	0x00		
0x31									w/r	0xFF		
0x30	fifo_water_mark_level_trigger_retain<5:0>								w/r	0x00		
0x2F	flat_hold_time<1:0>			flat_theta<5:0>		flat_hy<2:0>			w/r	0x11		
0x2E									w/r	0x08		
0x2D	orient_ud_en		orient_theta<5:0>							w/r	0x48	
0x2C	orient_hyst<2:0>			orient_blocking<1:0>		orient_mode<1:0>			w/r	0x18		
0x2B	tap_samp<1:0>		tap_th<4:0>							w/r	0x0A	
0x2A	tap_quiet	tap_shock	slo_no_mot_th<7:0>			tap_dur<2:0>			w/r	0x04		
0x29									w/r	0x14		
0x28	slo_no_mot_dur<5:0>				slo_th<7:0>		slo_dur<1:0>			w/r	0x14	
0x27									w/r	0x00		
0x26	high_th<7:0>				high_dur<7:0>					w/r	0xC0	
0x25					high_hy<1:0>		low_mode		low_hy<1:0>	w/r	0x0F	
0x24	high_hy<1:0>		low_th<7:0>			low_mode		low_hy<1:0>		w/r	0x81	
0x23									w/r	0x30		
0x22									w/r	0x09		
0x21	reset_int	latch_int<3:0>							w/r	0x00		
0x20					int2_od	int2_lm	int1_od	int1_lm	w/r	0x05		
0x1F									w/r	0xFF		
0x1E	int_src_data		int_src_tap	int_src_slo_no_mot	int_src_slope	int_src_high	int_src_low		w/r	0x00		
0x1D									w/r	0xFF		
0x1C									w/r	0xFF		
0x1B	int2_flat	int2_orient	int2_s_tap	int2_d_tap	int2_slo_no_mot	int2_slope	int2_high	int2_low	w/r	0x00		
0x1A	int2_data	int2_fwm	int2_full					int1_full	int1_fwm	int1_data	w/r	0x00
0x19	int1_flat	int1_orient	int1_s_tap	int1_d_tap	int1_slo_no_mot	int1_slope	int1_high	int1_low	w/r	0x00		
0x18					slo_no_mot_sel	slo_no_mot_en_z	slo_no_mot_en_y	slo_no_mot_en_x		w/r	0x00	
0x17	int_fwm_en		int_full_en	data_en	low_en	high_en_z	high_en_y	high_en_x	w/r	0x00		
0x16	flat_en	orient_en	s_tap_en	d_tap_en	slope_en_z		slope_en_y	slope_en_x	w/r	0x00		
0x15									w/r	0xFF		
0x14	softreset								wo	0x00		
0x13	data_high_bw	shadow_dis								w/r	0x00	
0x12	lowpower_mode		sleeptimer_mode							w/r	0x00	
0x11	suspend	lowpower_en	deep_suspend	sleep_dur<3:0>							w/r	0x00
0x10					bw<4:0>						w/r	0x0F
0x0F					range<3:0>						w/r	0x03
0x0E	fifo_overrun	fifo_frame_counter<6:0>								ro	0x00	
0x0D									w/r	0xFF		
0x0C	flat	orient<2:0>			high_sign	high_first_z	high_first_y	high_first_x	ro	0x00		
0x0B	tap_sign	tap_first_z	tap_first_y	tap_first_x	slope_sign	slope_first_z	slope_first_y	slope_first_x	ro	0x00		
0x0A	data_int	fifo_wm_int	fifo_full_int								ro	0x00
0x09	flat_int	orient_int	s_tap_int	d_tap_int	slo_no_mot_int	slope_int	high_int	low_int	ro	0x00		
0x08	temp<7:0>								ro	0x00		
0x07	acc_z_msb<7:0>								ro	0x00		
0x06								new_data_z	ro	0x00		
0x05	acc_y_msb<7:0>								ro	0x00		
0x04								new_data_y	ro	0x00		
0x03	acc_x_msb<7:0>								ro	0x00		
0x02								new_data_x	ro	0x00		
0x01									ro	-		
0x00	chip_id<7:0>								ro	0xF8		

	common w/r registers: Application specific settings which are not equal to the default settings, must be re-set to its designated values after POR, soft-reset and wake up from deep suspend.
	user w/r registers: Initial default content = 0x00. Freely programmable by the user. Remains unchanged after POR, soft-reset and wake up from deep suspend.

Figure 12: Register map

 BOSCH	BMA223 Preliminary data sheet	Page 50 Confidential
--	---	-------------------------

Register 0x00 (BGW_CHIPID)

The register contains the chip identification code.

Name	0x00	BGW_CHIPID		
Bit	7	6	5	4
Read/Write	R	R	R	R
Reset Value	n/a	n/a	n/a	n/a
Content	chip_id<7:4>			

Bit	3	2	1	0
Read/Write	R	R	R	R
Reset Value	n/a	n/a	n/a	n/a
Content	chip_id<3:0>			

chip_id<7:0>: Fixed value b'1111'1000

Register 0x02 (ACCD_X_LSB)

The register contains the X-channel new_data flag (new_data_x). When reading out the X-channel new_data_x flag, consistency between the flag and the acceleration data flag is guaranteed if the ACCD_X_LSB is read out before the ACCD_X_MSB and shadow_dis='0'. In this case, after ACCD_X_LSB has been read, the value in the ACCD_X_MSB register is locked until ACCD_X_MSB has been read. This condition is inherently fulfilled if a burst-mode read access is performed. Acceleration data may be read from register ACCD_X_LSB at any time except during power-up and in DEEP_SUSPEND mode.

Name	0x02	ACCD_X_LSB		
Bit	7	6	5	4
Read/Write	R	R	R	R
Reset Value	n/a	n/a	n/a	n/a
Content	undefined	undefined	undefined	undefined

Bit	3	2	1	0
Read/Write	R	R	R	R
Reset Value	n/a	n/a	n/a	n/a
Content	undefined	undefined	undefined	new_data_x

undefined: random data; to be ignored.

new_data_x: ,0': acceleration value has not been updated since it has been read out last
,1': acceleration value has been updated since it has been read out last

 BOSCH	BMA223 Preliminary data sheet	Page 51 Confidential
--	---	-------------------------

Register 0x03 (ACCD_X_MSB)

The register contains the most-significant bits of the X-channel acceleration readout value. When reading out X-channel acceleration values, consistency between data and new_data_x flag is guaranteed if the ACCD_X_LSB is read out before the ACCD_X_MSB and shadow_dis='0'. In this case, after the ACCD_X_LSB has been read, the value in the ACCD_X_MSB register is locked until the ACCD_X_MSB has been read. This condition is inherently fulfilled if a burst-mode read access is performed. Acceleration data may be read from register ACCD_X_MSB at any time except during power-up and in DEEP_SUSPEND mode.

Name	0x02	ACCD_X_MSB		
Bit	7	6	5	4
Read/Write	R	R	R	R
Reset Value	n/a	n/a	n/a	n/a
Content	acc_x_msb<7:4>			
Bit	3	2	1	0
Read/Write	R	R	R	R
Reset Value	n/a	n/a	n/a	n/a
Content	acc_x_msb<3:0>			

acc_x_msb<7:0>: Most significant 8 bits of acceleration read-back value (two's-complement format)

 BOSCH	BMA223 Preliminary data sheet	Page 52 Confidential
--	---	-------------------------

Register 0x04 (ACCD_Y_LSB)

The register contains the Y-channel new_data flag (new_data_y). When reading out the Y-channel new_data_y flag, consistency between the flag and the acceleration data flag is guaranteed if the ACCD_Y_LSB is read out before the ACCD_Y_MSB and shadow_dis='0'. In this case, after ACCD_Y_LSB has been read, the value in the ACCD_Y_MSB register is locked until ACCD_Y_MSB has been read. This condition is inherently fulfilled if a burst-mode read access is performed. Acceleration data may be read from register ACCD_Y_LSB at any time except during power-up and in DEEP_SUSPEND mode.

Name	0x04	ACCD_Y_LSB		
Bit	7	6	5	4
Read/Write	R	R	R	R
Reset Value	n/a	n/a	n/a	n/a
Content	undefined	undefined	undefined	undefined

Bit	3	2	1	0
Read/Write	R	R	R	R
Reset Value	n/a	n/a	n/a	n/a
Content	undefined	undefined	undefined	new_data_y

undefined: random data; to be ignored

new_data_y: ,0': acceleration value has not been updated since it has been read out last
,1': acceleration value has been updated since it has been read out last

 BOSCH	BMA223 Preliminary data sheet	Page 53 Confidential
--	---	-------------------------

Register 0x05 (ACCD_Y_MSB)

The register contains the most-significant bits of the Y-channel acceleration readout value. When reading out Y-channel acceleration values, consistency between data and new_data_y flag is guaranteed if the ACCD_Y_LSB is read out before the ACCD_Y_MSB and shadow_dis='0'. In this case, after the ACCD_Y_LSB has been read, the value in the ACCD_Y_MSB register is locked until the ACCD_Y_MSB has been read. This condition is inherently fulfilled if a burst-mode read access is performed. Acceleration data may be read from register ACCD_Y_MSB at any time except during power-up and in DEEP_SUSPEND mode.

Name	0x05	ACCD_Y_MSB		
Bit	7	6	5	4
Read/Write	R	R	R	R
Reset Value	n/a	n/a	n/a	n/a
Content	acc_y_msb<7:4>			
Bit	3	2	1	0
Read/Write	R	R	R	R
Reset Value	n/a	n/a	n/a	n/a
Content	acc_y_msb<3:0>			

acc_y_msb<7:0>: Most significant 8 bits of acceleration read-back value (two's-complement format)

 BOSCH	BMA223 Preliminary data sheet	Page 54 Confidential
--	---	-------------------------

Register 0x06 (ACCD_Z_LSB)

The register contains the Z-channel new_data flag (new_data_z). When reading out the Z-channel new_data_z flag, consistency between the flag and the acceleration data flag is guaranteed if the ACCD_Z_LSB is read out before the ACCD_Z_MSB and shadow_dis='0'. In this case, after ACCD_Z_LSB has been read, the value in the ACCD_Z_MSB register is locked until ACCD_Z_MSB has been read. This condition is inherently fulfilled if a burst-mode read access is performed. Acceleration data may be read from register ACCD_Z_LSB at any time except during power-up and in DEEP_SUSPEND mode.

Name	0x06	ACCD_Z_LSB		
Bit	7	6	5	4
Read/Write	R	R	R	R
Reset Value	n/a	n/a	n/a	n/a
Content	undefined	undefined	undefined	undefined
Bit	3	2	1	0
Read/Write	R	R	R	R
Reset Value	n/a	n/a	n/a	n/a
Content	undefined	undefined	undefined	new_data_z

undefined: random data; to be ignored
new_data_z: ,0': acceleration value has not been updated since it has been read out last
,1': acceleration value has been updated since it has been read out last

 BOSCH	BMA223 Preliminary data sheet	Page 55 Confidential
--	---	-------------------------

Register 0x07 (ACCD_Z_MSB)

The register contains the most-significant bits of the Z-channel acceleration readout value. When reading out Z-channel acceleration values, consistency between data and new_data_z flag is guaranteed if the ACCD_Z_LSB is read out before the ACCD_Z_MSB and shadow_dis='0'. In this case, after the ACCD_Z_LSB has been read, the value in the ACCD_Z_MSB register is locked until the ACCD_Z_MSB has been read. This condition is inherently fulfilled if a burst-mode read access is performed. Acceleration data may be read from register ACCD_Z_MSB at any time except during power-up and in DEEP_SUSPEND mode.

Name	0x07	ACCD_Z_MSB		
Bit	7	6	5	4
Read/Write	R	R	R	R
Reset Value	n/a	n/a	n/a	n/a
Content	acc_z_msb<7:4>			
Bit	3	2	1	0
Read/Write	R	R	R	R
Reset Value	n/a	n/a	n/a	n/a
Content	acc_z_msb<3:0>			

acc_z_msb<7:0>: Most significant 8 bits of acceleration read-back value (two's-complement format)

 BOSCH	BMA223 Preliminary data sheet	Page 56 Confidential
--	---	-------------------------

Register 0x08 (ACCD_TEMP)

The register contains the current chip temperature represented in two's complement format. A readout value of temp<7:0>=0x00 corresponds to a temperature of 23°C.

Name	0x08	ACCD_TEMP		
Bit	7	6	5	4
Read/Write	R	R	R	R
Reset Value	n/a	n/a	n/a	n/a
Content	temp<7:4>			

Bit	3	2	1	0
Read/Write	R	R	R	R
Reset Value	n/a	n/a	n/a	n/a
Content	temp<3:0>			

temp<7:0>: Temperature value (two's complement format)

 BOSCH	BMA223 Preliminary data sheet	Page 57 Confidential
--	---	-------------------------

Register 0x09 (INT_STATUS_0)

The register contains interrupt status flags. Each flag is associated with a specific interrupt function. It is set when the associated interrupt triggers. The setting of latch_int<3:0> controls if the interrupt signal and hence the respective interrupt flag will be permanently latched, temporarily latched or not latched. The interrupt function associated with a specific status flag must be enabled.

Name	0x09	INT_STATUS_0		
Bit	7	6	5	4
Read/Write	R	R	R	R
Reset Value	n/a	n/a	n/a	n/a
Content	flat_int	orient_int	s_tap_int	d_tap_int

Bit	3	2	1	0
Read/Write	R	R	R	R
Reset Value	n/a	n/a	n/a	n/a
Content	slo_no_mot_int	slope_int	high_int	low_int

flat_int: flat interrupt status: '0'→inactive, '1' →active
orient_int: orientation interrupt status: '0'→inactive, '1' →active
s_tap_int: single tap interrupt status: '0'→inactive, '1' →active
d_tap_int: double tap interrupt status: '0'→inactive, '1' →active
slo_not_mot_int: slow/no-motion interrupt status: '0'→inactive, '1' →active
slope_int: slope interrupt status: '0'→inactive, '1' →active
high_int: high-g interrupt status: '0'→inactive, '1' →active
low_int: low-g interrupt status: '0'→inactive, '1' →active

 BOSCH	BMA223 Preliminary data sheet	Page 58 Confidential
--	---	-------------------------

Register 0x0A (INT_STATUS_1)

The register contains interrupt status flags. Each flag is associated with a specific interrupt function. It is set when the associated interrupt engine triggers. The setting of latch_int<3:0> controls if the interrupt signal and hence the respective interrupt flag will be permanently latched, temporarily latched or not latched. The interrupt function associated with a specific status flag must be enabled.

Name	0x0A	INT_STATUS_1		
Bit	7	6	5	4
Read/Write	R	R	R	R
Reset Value	n/a	n/a	n/a	n/a
Content	data_int	fifo_wm_int	fifo_full_int	reserved

Bit	3	2	1	0
Read/Write	R	R	R	R
Reset Value	n/a	n/a	n/a	n/a
Content	reserved			

data_int: data ready interrupt status: '0'→inactive, '1' →active
fifo_wm_int: FIFO watermark interrupt status: '0'→inactive, '1' →active
fifo_full_int: FIFO full interrupt status: '0'→inactive, '1' →active
reserved: reserved, write to '0'

 BOSCH	BMA223 Preliminary data sheet	Page 59 Confidential
--	---	-------------------------

Register 0x0B (INT_STATUS_2)

The register contains interrupt status flags. Each flag is associated with a specific interrupt engine. It is set when the associated interrupt engine triggers. The setting of latch_int<3:0> controls if the interrupt signal and hence the respective interrupt flag will be permanently latched, temporarily latched or not latched. The interrupt function associated with a specific status flag must be enabled.

Name	0x0B	INT_STATUS_2		
Bit	7	6	5	4
Read/Write	R	R	R	R
Reset Value	n/a	n/a	n/a	n/a
Content	tap_sign	tap_first_z	tap_first_y	tap_first_x

Bit	3	2	1	0
Read/Write	R	R	R	R
Reset Value	n/a	n/a	n/a	n/a
Content	slope_sign	slope_first_z	slope_first_y	slope_first_x

tap_sign:	sign of single/double tap triggering signal was '0' → positive, or '1' → negative
tap_first_z:	single/double tap interrupt: '1' → triggered by, or '0' → not triggered by z-axis
tap_first_y:	single/double tap interrupt: '1' → triggered by, or '0' → not triggered by y-axis
tap_first_x:	single/double tap interrupt: '1' → triggered by, or '0' → not triggered by x-axis
slope_sign:	slope sign of slope tap triggering signal was '0' → positive, or '1' → negative
slope_first_z:	slope interrupt: '1' → triggered by, or '0' → not triggered by z-axis
slope_first_y:	slope interrupt: '1' → triggered by, or '0' → not triggered by y-axis
slope_first_x:	slope interrupt: '1' → triggered by, or '0' → not triggered by x-axis

 BOSCH	BMA223 Preliminary data sheet	Page 60 Confidential
--	---	-------------------------

Register 0x0C (INT_STATUS_3)

The register contains interrupt status flags. Each flag is associated with a specific interrupt engine. It is set when the associated interrupt engine triggers. With the exception of orient<3:0> the setting of latch_int<3:0> controls if the interrupt signal and hence the respective interrupt flag will be permanently latched, temporarily latched or not latched. The interrupt function associated with a specific status flag must be enabled.

Name	0x0C	INT_STATUS_3		
Bit	7	6	5	4
Read/Write	R	R	R	R
Reset Value	n/a	n/a	n/a	n/a
Content	flat	orient<2:0>		

Bit	3	2	1	0
Read/Write	R	R	R	R
Reset Value	n/a	n/a	n/a	n/a
Content	high_sign	high_first_z	high_first_y	high_first_x

flat:	device is in '1' → flat, or '0' → non flat position; only valid if (0x16) flat_en = '1'
orient<2>:	Orientation value of z-axis: '0' → upward looking, or '1' → downward looking. The flag always reflect the current orientation status, independent of the setting of latch_int<3:0>. The flag is not updated as long as an orientation blocking condition is active.
orient<1:0>:	orientation value of x-y-plane: '00' → portrait upright; '01' → portrait upside down; '10' → landscape left; '11' → landscape right; The flags always reflect the current orientation status, independent of the setting of latch_int<3:0>. The flag is not updated as long as an orientation blocking condition is active.
high_sign:	sign of acceleration signal that triggered high-g interrupt was '0' → positive, '1' → negative
high_first_z:	high-g interrupt: '1' → triggered by, or '0' → not triggered by z-axis
high_first_y:	high-g interrupt: '1' → triggered by, or '0' → not triggered by y-axis
high_first_x:	high-g interrupt: '1' → triggered by, or '0' → not triggered by x-axis

 BOSCH	BMA223 Preliminary data sheet	Page 61 Confidential
--	---	-------------------------

Register 0x0E (FIFO_STATUS)

The register contains FIFO status flags.

Name	0x0E	FIFO_STATUS		
Bit	7	6	5	4
Read/Write	R	R	R	R
Reset Value	n/a	n/a	n/a	n/a
Content	fifo_overrun	fifo_frame_counter<6:4>		

Bit	3	2	1	0
Read/Write	R	R	R	R
Reset Value	n/a	n/a	n/a	n/a
Content	fifo_frame_counter<3:0>			

fifo_overrun: FIFO overrun condition has '1' → occurred, or '0' → not occurred; flag can be cleared by writing to the FIFO configuration register FIFO_CONFIG_1 only

fifo_frame_counter<6:4>: Current fill level of FIFO buffer. An empty FIFO corresponds to 0x00. The frame counter can be cleared by reading out all frames from the FIFO buffer or writing to the FIFO configuration register FIFO_CONFIG_1.

 BOSCH	BMA223 Preliminary data sheet	Page 62 Confidential
--	---	-------------------------

Register 0x0F (PMU_RANGE)

The register allows the selection of the accelerometer g-range.

Name	0x0F	PMU_RANGE		
Bit	7	6	5	4
Read/Write	R/W	R/W	R/W	R/W
Reset Value	0	0	0	0
Content	reserved			
0				
Bit	3	2	1	0
Read/Write	R/W	R/W	R/W	R/W
Reset Value	0	0	1	1
Content	range<3:0>			

range<3:0>: Selection of accelerometer g-range:
'0011b' → ±2g range; '0101b' → ±4g range; '1000b' → ±8g range;
'1100b' → ±16g range; all other settings → ±2g range

reserved: write '0'

Register 0x10 (PMU_BW)

The register allows the selection of the acceleration data filter bandwidth.

Name	0x10	PMU_BW		
Bit	7	6	5	4
Read/Write	R/W	R/W	R/W	R/W
Reset Value	0	0	0	0
Content	reserved			bw<4>
0				
Bit	3	2	1	0
Read/Write	R/W	R/W	R/W	R/W
Reset Value	1	1	1	1
Content	bw<3:0>			

bw<4:0>: Selection of data filter bandwidth:
'00xxxb' → 7.81 Hz, '01000b' → 7.81 Hz, '01001b' → 15.63 Hz,
'01010b' → 31.25 Hz, '01011b' → 62.5 Hz, '01100b' → 125 Hz,
'01101b' → 250 Hz, '01110b' → 500 Hz, '01111b' → 1000 Hz,
'1xxxxb' → 1000 Hz

reserved: write '0'

 BOSCH	BMA223 Preliminary data sheet	Page 63 Confidential
--	---	-------------------------

Register 0x11 (PMU_LPW)

Selection of the main power modes and the low power sleep period.

Name	0x11	PMU_LPW		
Bit	7	6	5	4
Read/Write	R/W	R/W	R/W	R/W
Reset Value	0	0	0	0
Content	suspend	lowpower_en	deep_suspend	sleep_dur<3>
Bit	3	2	1	0
Read/Write	R/W	R/W	R/W	R/W
Reset Value	0	0	0	0
Content	sleep_dur<2:0>			reserved

suspend, low_power_en, deep_suspend:

Main power mode configuration setting {suspend; lowpower_en; deep_suspend}:

{0; 0; 0} → NORMAL mode;
 {0; 0; 1} → DEEP_SUSPEND mode;
 {0; 1; 0} → LOW_POWER mode;
 {1; 0; 0} → SUSPEND mode;
 {all other} → illegal

Please note that only certain power mode transitions are permitted.

sleep_dur<3:0>: Configures the sleep phase duration in LOW_POWER mode:

'0000b' to '0101b' → 0.5 ms, '0110b' → 1 ms,
 '0111b' → 2 ms, '1000b' → 4 ms,
 '1001b' → 6 ms, '1010b' → 10 ms,
 '1011b' → 25 ms, '1100b' → 50 ms,
 '1101b' → 100 ms, '1110b' → 500 ms,
 '1111b' → 1 s

Please note, that all application specific settings which are not equal to the default settings (refer to 6.2 register map), must be re-set to its designated values after DEEP_SUSPEND.

 BOSCH	BMA223 Preliminary data sheet	Page 64 Confidential
--	---	-------------------------

Register 0x12 (PMU_LOW_POWER)

Configuration settings for low power mode.

Name	0x12	PMU_LOW_POWER		
Bit	7	6	5	4
Read/Write	R/W	R/W	R/W	R/W
Reset Value	0	0	0	0
Content	reserved	lowpower_mode	sleeptimer_mode	reserved

Bit	3	2	1	0
Read/Write	R/W	R/W	R/W	R/W
Reset Value	0	0	0	0
Content	reserved			

lowpower_mode: select '0' → LPM1, or '1' → LPM2 configuration for SUSPEND and LOW_POWER mode. In the LPM1 configuration the power consumption in LOW_POWER mode and SUSPEND mode is significantly reduced when compared to LPM2 configuration, but the FIFO is not accessible and writing to registers must be slowed down. In the LPM2 configuration the power consumption in LOW_POWER mode is reduced compared to NORMAL mode, but the FIFO is fully accessible and registers can be written to at full speed.

sleeptimer_mode: when in LOW_POWER mode '0' → use event-driven time-base mode (compatible with BMA250), or '1' → use equidistant sampling time-base mode. Equidistant sampling of data into the FIFO is maintained in equidistant time-base mode only.

reserved: write '0'

 BOSCH	BMA223 Preliminary data sheet	Page 65 Confidential
--	---	-------------------------

Register 0x13 (ACCD_HBW)

Acceleration data acquisition and data output format.

Name	0x13	ACCD_HBW		
Bit	7	6	5	4
Read/Write	R/W	R/W	R/W	R/W
Reset Value	0	0 (1 in 8-bit mode)	0	0
Content	data_high_bw	shadow_dis	reserved	

Bit	3	2	1	0
Read/Write	R/W	R/W	R/W	R/W
Reset Value	0	0	0	0
Content	reserved			

data_high_bw: select whether '1' → unfiltered, or '0' → filtered data may be read from the acceleration data registers.

shadow_dis: '1' → disable, or '0' → the shadowing mechanism for the acceleration data output registers. When shadowing is enabled, the content of the acceleration data component in the MSB register is locked, when the component in the LSB is read, thereby ensuring the integrity of the acceleration data during read-out. The lock is removed when the MSB is read.

reserved: write '0'

 BOSCH	BMA223 Preliminary data sheet	Page 66 Confidential
--	---	-------------------------

Register 0x14 (BGW_SOFTRESET)

Controls user triggered reset of the sensor.

Name	0x14	BGW_SOFTRESET		
Bit	7	6	5	4
Read/Write	W	W	W	W
Reset Value	0	0	0	0
Content	softreset			

Bit	3	2	1	0
Read/Write	W	W	W	W
Reset Value	0	0	0	0
Content	softreset			

softreset: 0xB6 → triggers a reset. Other values are ignored. Following a delay, all user configuration settings are overwritten with their default state or the setting stored in the NVM, wherever applicable. This register is functional in all operation modes. Please note that all application specific settings which are not equal to the default settings (refer to 6.2 register map), must be reconfigured to their designated values.

Register 0x16 (INT_EN_0)

Controls which interrupt engines in group 0 are enabled.

Name	0x16	INT_EN_0		
Bit	7	6	5	4
Read/Write	R/W	R/W	R/W	R/W
Reset Value	0	0	0	0
Content	flat_en	orient_en	s_tap_en	d_tap_en

Bit	3	2	1	0
Read/Write	R/W	R/W	R/W	R/W
Reset Value	0	0	0	0
Content	reserved	slope_en_z	slope_en_y	slope_en_x

flat_en: flat interrupt: '0' → disabled, or '1' → enabled
orient_en: orientation interrupt: '0' → disabled, or '1' → enabled
s_tap_en: single tap interrupt: '0' → disabled, or '1' → enabled
d_tap_en: double tap interrupt: '0' → disabled, or '1' → enabled
reserved: write '0'
slope_en_z: slope interrupt, z-axis component: '0' → disabled, or '1' → enabled
slope_en_y: slope interrupt, y-axis component: '0' → disabled, or '1' → enabled
slope_en_x: slope interrupt, x-axis component: '0' → disabled, or '1' → enabled

 BOSCH	BMA223 Preliminary data sheet	Page 67 Confidential
--	---	-------------------------

Register 0x17 (INT_EN_1)

Controls which interrupt engines in group 1 are enabled.

Name	0x17	INT_EN_1		
Bit	7	6	5	4
Read/Write	R/W	R/W	R/W	R/W
Reset Value	0	0	0	0
Content	reserved	int_fwm_en	int_full_en	data_en

Bit	3	2	1	0
Read/Write	R/W	R/W	R/W	R/W
Reset Value	0	0	0	0
Content	low_en	high_en_z	high_en_y	high_en_x

reserved: write '0'

int_fwm_en: FIFO watermark interrupt: '0'→disabled, or '1' →enabled

int_full_en: FIFO full interrupt: '0'→disabled, or '1' →enabled

data_en: data ready interrupt: '0'→disabled, or '1' →enabled

low_en: low-g interrupt: '0'→disabled, or '1' →enabled

high_en_z: high-g interrupt, z-axis component: '0'→disabled, or '1' →enabled

high_en_y: high-g interrupt, y-axis component: '0'→disabled, or '1' →enabled

high_en_x: high-g interrupt, x-axis component: '0'→disabled, or '1' →enabled

 BOSCH	BMA223 Preliminary data sheet	Page 68 Confidential
--	---	-------------------------

Register 0x18 (INT_EN_2)

Controls which interrupt engines in group 2 are enabled.

Name	0x18	INT_EN_2		
Bit	7	6	5	4
Read/Write	R/W	R/W	R/W	R/W
Reset Value	0	0	0	0
Content	reserved			

Bit	3	2	1	0
Read/Write	R/W	R/W	R/W	R/W
Reset Value	0	0	0	0
Content	slo_no_mot_sel	slo_no_mot_en_z	slo_no_mot_en_y	slo_no_mot_en_x

reserved: write '0'

slo_no_mot_sel: select '0'→slow-motion, '1' →no-motion interrupt function

slo_no_mot_en_z: slow/n-motion interrupt, z-axis component: '0'→disabled, or '1' →enabled

slo_no_mot_en_y: slow/n-motion interrupt, y-axis component: '0'→disabled, or '1' →enabled

slo_no_mot_en_x: slow/n-motion interrupt, x-axis component: '0'→disabled, or '1' →enabled

 BOSCH	BMA223 Preliminary data sheet	Page 69 Confidential
--	---	-------------------------

Register 0x19 (INT_MAP_0)

Controls which interrupt signals are mapped to the INT1 pin.

Name	0x19	INT_MAP_0		
Bit	7	6	5	4
Read/Write	R/W	R/W	R/W	R/W
Reset Value	0	0	0	0
Content	int1_flat	int1_orient	int1_s_tap	int1_d_tap

Bit	3	2	1	0
Read/Write	R/W	R/W	R/W	R/W
Reset Value	0	0	0	0
Content	int1_slo_no_mot	int1_slope	int1_high	int1_low

int1_flat: map flat interrupt to INT1 pin: '0'→disabled, or '1' →enabled
int1_orient: map orientation interrupt to INT1 pin: '0'→disabled, or '1' →enabled
int1_s_tap: map single tap interrupt to INT1 pin: '0'→disabled, or '1' →enabled
int1_d_tap: map double tap interrupt to INT1 pin: '0'→disabled, or '1' →enabled
int1_slo_no_mot: map slow/no-motion interrupt to INT1 pin: '0'→disabled, or '1' →enabled
int1_slope: map slope interrupt to INT1 pin: '0'→disabled, or '1' →enabled
int1_high: map high-g to INT1 pin: '0'→disabled, or '1' →enabled
int1_low: map low-g to INT1 pin: '0'→disabled, or '1' →enabled

 BOSCH	BMA223 Preliminary data sheet	Page 70 Confidential
--	---	-------------------------

Register 0x1A (INT_MAP_1)

Controls which interrupt signals are mapped to the INT1 and INT2 pins.

Name	0x1A	INT_MAP_1		
Bit	7	6	5	4
Read/Write	R/W	R/W	R/W	R/W
Reset Value	0	0	0	0
Content	int2_data	int2_fwm	int2_ffull	reserved

Bit	3	2	1	0
Read/Write	R/W	R/W	R/W	R/W
Reset Value	0	0	0	0
Content	reserved	int1_ffull	int1_fwm	int1_data

int2_data: map data ready interrupt to INT2 pin: '0'→disabled, or '1' →enabled
int2_fwm: map FIFO watermark interrupt to INT2 pin: '0'→disabled, or '1' →enabled
int2_ffull: map FIFO full interrupt to INT2 pin: '0'→disabled, or '1' →enabled
reserved: write '0'
int1_ffull: map FIFO full interrupt to INT1 pin: '0'→disabled, or '1' →enabled
int1_fwm: map FIFO watermark interrupt to INT1 pin: '0'→disabled, or '1' →enabled
int1_data: map data ready interrupt to INT1 pin: '0'→disabled, or '1' →enabled

 BOSCH	BMA223 Preliminary data sheet	Page 71 Confidential
--	---	-------------------------

Register 0x1B (INT_MAP_2)

Controls which interrupt signals are mapped to the INT2 pin.

Name	0x1B	INT_MAP_2		
Bit	7	6	5	4
Read/Write	R/W	R/W	R/W	R/W
Reset Value	0	0	0	0
Content	int2_flat	int2_orient	int2_s_tap	int2_d_tap

Bit	3	2	1	0
Read/Write	R/W	R/W	R/W	R/W
Reset Value	0	0	0	0
Content	int2_slo_no_mot	int2_slope	int2_high	int2_low

int2_flat:	map flat interrupt to INT2 pin: '0'→disabled, or '1' →enabled
int2_orient:	map orientation interrupt to INT2 pin: '0'→disabled, or '1' →enabled
int2_s_tap:	map single tap interrupt to INT2 pin: '0'→disabled, or '1' →enabled
int2_d_tap:	map double tap interrupt to INT2 pin: '0'→disabled, or '1' →enabled
int2_slo_no_mot:	map slow/no-motion interrupt to INT2 pin: '0'→disabled, or '1' →enabled
int2_slope:	map slope interrupt to INT2 pin: '0'→disabled, or '1' →enabled
int2_high:	map high-g to INT2 pin: '0'→disabled, or '1' →enabled
int2_low:	map low-g to INT2 pin: '0'→disabled, or '1' →enabled

 BOSCH	BMA223 Preliminary data sheet	Page 72 Confidential
--	---	-------------------------

Register 0x1E (INT_SRC)

Contains the data source definition for interrupts with selectable data source.

Name	0x1E	INT_SRC		
Bit	7	6	5	4
Read/Write	R/W	R/W	R/W	R/W
Reset Value	0	0	0	0
Content	reserved		int_src_data	int_src_tap

Bit	3	2	1	0
Read/Write	R/W	R/W	R/W	R/W
Reset Value	0	0	0	0
Content	int_src_slo_no_mot	int_src_slope	int_src_high	int_src_low

reserved: write '0'

int_src_data: select '0'→filtered, or '1' →unfiltered data for new data interrupt

int_src_tap: select '0'→filtered, or '1' →unfiltered data for single-/double tap interrupt

int_src_slo_no_mot: select '0'→filtered, or '1' →unfiltered data for slow/no-motion interrupt

int_src_slope: select '0'→filtered, or '1' →unfiltered data for slope interrupt

int_src_high: select '0'→filtered, or '1' →unfiltered data for high-g interrupt

int_src_low: select '0'→filtered, or '1' →unfiltered data for low-g interrupt

 BOSCH	BMA223 Preliminary data sheet	Page 73 Confidential
--	---	-------------------------

Register 0x20 (INT_OUT_CTRL)

Contains the behavioural configuration (electrical behaviour) of the interrupt pins.

Name	0x20	INT_OUT_CTRL		
Bit	7	6	5	4
Read/Write	R/W	R/W	R/W	R/W
Reset Value	0	0	0	0
Content	reserved			

Bit	3	2	1	0
Read/Write	R/W	R/W	R/W	R/W
Reset Value	0	1	0	1
Content	int2_od	int2_lvl	int1_od	int1_lvl

reserved: write '0'
int2_od: select '0' → push-pull, or '1' → open drain behavior for INT2 pin
int2_lvl: select '0' → active low, or '1' → active high level for INT2 pin
int1_od: select '0' → push-pull, or '1' → open drain behavior for INT1 pin
int1_lvl: select '0' → active low, or '1' → active high level for INT1 pin

 BOSCH	BMA223 Preliminary data sheet	Page 74 Confidential
--	---	-------------------------

Register 0x21 (INT_RST_LATCH)

Contains the interrupt reset bit and the interrupt mode selection.

Name	0x21	INT_RST_LATCH		
Bit	7	6	5	4
Read/Write	W	R/W	R/W	R/W
Reset Value	0	0	0	0
Content	reset_int	Reserved		

Bit	3	2	1	0
Read/Write	R/W	R/W	R/W	R/W
Reset Value	0	0	0	0
Content	latch_int<3:0>			

reset_int: write '1' → clear any latched interrupts, or '0' → keep latched interrupts active

reserved: write '0'

latch_int<3:0>: '0000b' → non-latched, '0001b' → temporary, 250 ms,
 '0010b' → temporary, 500 ms, '0011b' → temporary, 1 s,
 '0100b' → temporary, 2 s, '0101b' → temporary, 4 s,
 '0110b' → temporary, 8 s, '0111b' → latched,
 '1000b' → non-latched, '1001b' → temporary, 250 μs,
 '1010b' → temporary, 500 μs, '1011b' → temporary, 1 ms,
 '1100b' → temporary, 12.5 ms, '1101b' → temporary, 25 ms,
 '1110b' → temporary, 50 ms, '1111b' → latched

Register 0x22 (INT_0)

Contains the delay time definition for the low-g interrupt.

Name	0x22	INT_0		
Bit	7	6	5	4
Read/Write	W	R/W	R/W	R/W
Reset Value	0	0	0	0
Content	low_dur<7:4>			

Bit	3	2	1	0
Read/Write	R/W	R/W	R/W	R/W
Reset Value	1	0	0	1
Content	low_dur<3:0>			

low_dur<7:0>: low-g interrupt trigger delay according to $[low_dur<7:0> + 1] \cdot 2$ ms in a range from 2 ms to 512 ms; the default corresponds to a delay of 20 ms.

 BOSCH	BMA223 Preliminary data sheet	Page 75 Confidential
--	---	-------------------------

Register 0x23 (INT_1)

Contains the threshold definition for the low-g interrupt.

Name	0x23	INT_1		
Bit	7	6	5	4
Read/Write	W	R/W	R/W	R/W
Reset Value	0	0	1	1
Content	low_th<7:4>			
Bit	3	2	1	0
Read/Write	R/W	R/W	R/W	R/W
Reset Value	0	0	0	0
Content	low_th<3:0>			

low_th<7:0>: low-g interrupt trigger threshold according to low_th<7:0> · 7.81 mg in a range from 0 g to 1.992 g; the default value corresponds to an acceleration of 375 mg

Register 0x24 (INT_2)

Contains the low-g interrupt mode selection, the low-g interrupt hysteresis setting, and the high-g interrupt hysteresis setting.

Name	0x24	INT_2		
Bit	7	6	5	4
Read/Write	R/W	R/W	R/W	R/W
Reset Value	1	0	0	0
Content	high_hy<1:0>		reserved	
Bit	3	2	1	0
Read/Write	R/W	R/W	R/W	R/W
Reset Value	0	0	0	1
Content	reserved	low_mode	low_hy<1:0>	

high_hy<1:0>: hysteresis of high-g interrupt according to high_hy<1:0> · 125 mg (2-g range), high_hy<1:0> · 250 mg (4-g range), high_hy<1:0> · 500 mg (8-g range), or high_hy<1:0> · 1000 mg (16-g range)

low_mode: select low-g interrupt '0' single-axis mode, or '1' axis-summing mode

low_hy<1:0>: hysteresis of low-g interrupt according to low_hy<1:0> · 125 mg independent of the selected accelerometer g-range

 BOSCH	BMA223 Preliminary data sheet	Page 76 Confidential
--	---	-------------------------

Register 0x25 (INT_3)

Contains the delay time definition for the high-g interrupt.

Name	0x25	INT_3		
Bit	7	6	5	4
Read/Write	R/W	R/W	R/W	R/W
Reset Value	0	0	0	0
Content	high_dur<7:4>			

Bit	3	2	1	0
Read/Write	R/W	R/W	R/W	R/W
Reset Value	1	1	1	1
Content	high_dur<3:0>			

high_dur<7:0>: high-g interrupt trigger delay according to $[high_dur<7:0> + 1] \cdot 2$ ms in a range from 2 ms to 512 ms; the default corresponds to a delay of 32 ms.

Register 0x26 (INT_4)

Contains the threshold definition for the high-g interrupt.

Name	0x26	INT_4		
Bit	7	6	5	4
Read/Write	R/W	R/W	R/W	R/W
Reset Value	1	1	0	0
Content	high_th<7:4>			

Bit	3	2	1	0
Read/Write	R/W	R/W	R/W	R/W
Reset Value	0	0	0	0
Content	high_th<3:0>			

high_th<7:0>: threshold of high-g interrupt according to $high_th<7:0> \cdot 7.81$ mg (2-g range), $high_th<7:0> \cdot 15.63$ mg (4-g range), $high_th<7:0> \cdot 31.25$ mg (8-g range), or $high_th<7:0> \cdot 62.5$ mg (16-g range)

 BOSCH	BMA223 Preliminary data sheet	Page 77 Confidential
--	---	-------------------------

Register 0x27 (INT_5)

Contains the definition of the number of samples to be evaluated for the slope interrupt (any-motion detection) and the slow/no-motion interrupt trigger delay.

Name	0x27	INT_5		
Bit	7	6	5	4
Read/Write	R/W	R/W	R/W	R/W
Reset Value	0	0	0	0
Content	slo_no_mot_dur<5:2>			

Bit	3	2	1	0
Read/Write	R/W	R/W	R/W	R/W
Reset Value	0	0	0	0
Content	slo_no_mot_dur<1:0>		slope_dur<1:0>	

slo_no_mot_dur<5:0>: Function depends on whether the slow-motion or no-motion interrupt function has been selected. If the slow-motion interrupt function has been enabled (slo_no_mot_sel = '0') then [slo_no_mot_dur<1:0>+1] consecutive slope data points must be above the slow/no-motion threshold (slo_no_mot_th) for the slow-/no-motion interrupt to trigger. If the no-motion interrupt function has been enabled (slo_no_mot_sel = '1') then slo_no_motion_dur<5:0> defines the time for which no slope data points must exceed the slow/no-motion threshold (slo_no_mot_th) for the slow/no-motion interrupt to trigger. The delay time in seconds may be calculated according with the following equation:

$$\begin{aligned} \text{slo_no_mot_dur<5:4>='b00'} &\rightarrow [\text{slo_no_mot_dur<3:0>} + 1] \\ \text{slo_no_mot_dur<5:4>='b01'} &\rightarrow [\text{slo_no_mot_dur<3:0>} \cdot 4 + 20] \\ \text{slo_no_mot_dur<5>='1'} &\rightarrow [\text{slo_no_mot_dur<4:0>} \cdot 8 + 88] \end{aligned}$$

slope_dur<1:0>: slope interrupt triggers if [slope_dur<1:0>+1] consecutive slope data points are above the slope interrupt threshold slope_th<7:0>

 BOSCH	BMA223 Preliminary data sheet	Page 78 Confidential
--	---	-------------------------

Register 0x28 (INT_6)

Contains the threshold definition for the any-motion interrupt.

Name	0x28	INT_6		
Bit	7	6	5	4
Read/Write	R/W	R/W	R/W	R/W
Reset Value	0	0	0	1
Content	slope_th<7:4>			

Bit	3	2	1	0
Read/Write	R/W	R/W	R/W	R/W
Reset Value	0	1	0	0
Content	slope_th<3:0>			

slope_th<7:0>: Threshold of the any-motion interrupt. It is range-dependent and defined as a sample-to-sample difference according to
 $\text{slope_th<7:0>} \cdot 3.91 \text{ mg (2-g range) /}$
 $\text{slope_th<7:0>} \cdot 7.81 \text{ mg (4-g range) /}$
 $\text{slope_th<7:0>} \cdot 15.63 \text{ mg (8-g range) /}$
 $\text{slope_th<7:0>} \cdot 31.25 \text{ mg (16-g range)}$

Register 0x29 (INT_7)

Contains the threshold definition for the slow/no-motion interrupt.

Name	0x29	INT_7		
Bit	7	6	5	4
Read/Write	R/W	R/W	R/W	R/W
Reset Value	0	0	0	1
Content	slo_no_mot_th<7:4>			

Bit	3	2	1	0
Read/Write	R/W	R/W	R/W	R/W
Reset Value	0	1	0	0
Content	slo_no_mot_th<3:0>			

slo_no_mot_th<7:0>: Threshold of slow/no-motion interrupt. It is range-dependent and defined as a sample-to-sample difference according to
 $\text{slo_no_mot_th<7:0>} \cdot 3.91 \text{ mg (2-g range),}$
 $\text{slo_no_mot_th<7:0>} \cdot 7.81 \text{ mg (4-g range),}$
 $\text{slo_no_mot_th<7:0>} \cdot 15.63 \text{ mg (8-g range),}$
 $\text{slo_no_mot_th<7:0>} \cdot 31.25 \text{ mg (16-g range)}$

 BOSCH	BMA223 Preliminary data sheet	Page 79 Confidential
--	---	-------------------------

Register 0x2A (INT_8)

Contains the timing definitions for the single tap and double tap interrupts.

Name	0x2A	INT_8		
Bit	7	6	5	4
Read/Write	R/W	R/W	R/W	R/W
Reset Value	0	0	0	0
Content	tap_quiet	tap_shock	reserved	reserved

Bit	3	2	1	0
Read/Write	R/W	R/W	R/W	R/W
Reset Value	0	1	0	0
Content	reserved	tap_dur<2:0>		

tap_quiet: selects a tap quiet duration of '0' → 30 ms, '1' → 20 ms
tap_shock: selects a tap shock duration of '0' → 50 ms, '1' → 75 ms
reserved: write '0'
tap_dur<2:0>: selects the length of the time window for the second shock event for double tap detection according to '000b' → 50 ms, '001b' → 100 ms, '010b' → 150 ms, '011b' → 200 ms, '100b' → 250 ms, '101b' → 375 ms, '110b' → 500 ms, '111b' → 700 ms.

 BOSCH	BMA223 Preliminary data sheet	Page 80 Confidential
--	---	-------------------------

Register 0x2B (INT_9)

Contains the definition of the number of samples processed by the single / double-tap interrupt engine after wake-up in low-power mode. It also defines the threshold definition for the single and double tap interrupts.

Name	0x2B	INT_9		
Bit	7	6	5	4
Read/Write	R/W	R/W	R/W	R/W
Reset Value	0	0	0	0
Content	tap_samp<1:0>	reserved		tap_th<4>
Bit	3	2	1	0
Read/Write	R/W	R/W	R/W	R/W
Reset Value	1	0	1	0
Content	tap_th<3:0>			

tap_samp<1:0>: selects the number of samples that are processed after wake-up in the low-power mode according to '00b' → 2 samples, '01b' → 4 samples, '10b' → 8 samples, and '11b' → 16 samples

reserved: write '0'

tap_th<3:0>: threshold of the single/double-tap interrupt corresponding to an acceleration difference of tap_th<3:0> · 62.5mg (2g-range), tap_th<3:0> · 125mg (4g-range), tap_th<3:0> · 250mg (8g-range), and tap_th<3:0> · 500mg (16g-range).

 BOSCH	BMA223 Preliminary data sheet	Page 81 Confidential
--	---	-------------------------

Register 0x2C (INT_A)

Contains the definition of hysteresis, blocking, and mode for the orientation interrupt

Name	0x2C	INT_A		
Bit	7	6	5	4
Read/Write	R/W	R/W	R/W	R/W
Reset Value	0	0	0	1
Content	reserved	orient_hyst<2:0>		

Bit	3	2	1	0
Read/Write	R/W	R/W	R/W	R/W
Reset Value	1	0	0	0
Content	orient_blocking<1:0>		orient_mode<1:0>	

reserved: write '0'

orient_hyst<2:0>: sets the hysteresis of the orientation interrupt; 1 LSB corresponds to 62.5 mg irrespective of the selected g-range

orient_blocking<1:0>: selects the blocking mode that is used for the generation of the orientation interrupt. The following blocking modes are available:

'00b' → no blocking,

'01b' → theta blocking or acceleration in any axis > 1.5g,

'10b' → ,theta blocking or acceleration slope in any axis > 0.2 g or acceleration in any axis > 1.5g

'11b' → theta blocking or acceleration slope in any axis > 0.4 g or acceleration in any axis > 1.5g and value of orient is not stable for at least 100ms

orient_mode<1:0>: sets the thresholds for switching between the different orientations. The settings: '00b' → symmetrical, '01b' → high-asymmetrical, '10b' → low-asymmetrical, '11b' → symmetrical.

 BOSCH	BMA223 Preliminary data sheet	Page 82 Confidential
--	---	-------------------------

Register 0x2D (INT_B)

Contains the definition of the axis orientation, up/down masking, and the theta blocking angle for the orientation interrupt.

Name	0x2D	INT_B		
Bit	7	6	5	4
Read/Write	R/W	R/W	R/W	R/W
Reset Value	n/a	1	0	0
Content	reserved	orient_ud_en	orient_theta<5:4>	
Bit	3	2	1	0
Read/Write	R/W	R/W	R/W	R/W
Reset Value	1	0	0	0
Content	orient_theta<3:0>			

orient_ud_en: change of up/down-bit '1' → generates an orientation interrupt, '0' → is ignored and will not generate an orientation interrupt

orient_theta<5:0>: defines a blocking angle between 0° and 44.8°

Register 0x2E (INT_C)

Contains the definition of the flat threshold angle for the flat interrupt.

Name	0x2E	INT_C		
Bit	7	6	5	4
Read/Write	R/W	R/W	R/W	R/W
Reset Value	n/a	n/a	0	0
Content	reserved	flat_theta<5:4>		
Bit	3	2	1	0
Read/Write	R/W	R/W	R/W	R/W
Reset Value	1	0	0	0
Content	flat_theta<3:0>			

reserved: write '0'

flat_theta<5:0>: defines threshold for detection of flat position in range from 0° to 44.8°.

 BOSCH	BMA223 Preliminary data sheet	Page 83 Confidential
--	---	-------------------------

Register 0x2F (INT_D)

Contains the definition of the flat interrupt hold time and flat interrupt hysteresis.

Name	0x2F	INT_D		
Bit	7	6	5	4
Read/Write	R/W	R/W	R/W	R/W
Reset Value	0	0	0	1
Content	reserved		flat_hold_time<1:0>	

Bit	3	2	1	0
Read/Write	R/W	R/W	R/W	R/W
Reset Value	0	0	0	1
Content	reserved	flat_hy<2:0>		

reserved: write '0'

flat_hold_time<1:0>: delay time for which the flat value must remain stable for the flat interrupt to be generated: '00b' → 0 ms, '01b' → 512 ms, '10b' → 1024 ms, '11b' → 2048 ms

flat_hy<2:0>: defines flat interrupt hysteresis; flat value must change by more than twice the value of flat interrupt hysteresis to detect a state change. For details see chapter 4.7.8.

'000b' → hysteresis of the flat detection disabled

 BOSCH	BMA223 Preliminary data sheet	Page 84 Confidential
--	---	-------------------------

Register 0x30 (FIFO_CONFIG_0)

Contains the FIFO watermark level.

Name	0x30	FIFO_CONFIG_0		
Bit	7	6	5	4
Read/Write	R/W	R/W	R/W	R/W
Reset Value	n/a	n/a	0	0
Content	reserved		fifo_water_mark_level_trigger_retain<5:4>	

Bit	3	2	1	0
Read/Write	R/W	R/W	R/W	R/W
Reset Value	0	0	0	0
Content	fifo_water_mark_level_trigger_retain<3:0>			

reserved: write '0'

fifo_water_mark_level_trigger_retain<5:0>:

fifo_water_mark_level_trigger_retain<5:0> defines the FIFO watermark level. An interrupt will be generated, when the number of entries in the FIFO exceeds fifo_water_mark_level_trigger_retain<5:0>;

 BOSCH	BMA223 Preliminary data sheet	Page 85 Confidential
--	---	-------------------------

Register 0x32 (PMU_SELF_TEST)

Contains the settings for the sensor self-test configuration and trigger.

Name	0x32	PMU_SELF_TEST		
Bit	7	6	5	4
Read/Write	R/W	R/W	R/W	R/W
Reset Value	0	0	0	0
Content	reserved			self_test_amp

Bit	3	2	1	0
Read/Write	R/W	R/W	R/W	R/W
Reset Value	0	0	0	0
Content	reserved_0	self_test_sign	self_test-axis<1:0>	

reserved: write '0x0'

reserved_0: write '0x0'

self_test_amp; select amplitude of the selftest deflection '1' → high, default value is low ('0')

self_test_sign: select sign of self-test excitation as '1' → positive, or '0' → negative

self_test_axis: select axis to be self-tested: '00b' → self-test disabled, '01b' → x-axis, '10b' → y-axis, or '11b' → z-axis; when a self-test is performed, only the acceleration data readout value of the selected axis is valid; after the self-test has been enabled a delay of a least 5 ms is necessary for the read-out value to settle

 BOSCH	BMA223 Preliminary data sheet	Page 86 Confidential
--	---	-------------------------

Register 0x33 (TRIM_NVM_CTRL)

Contains the control settings for the few-time programmable non-volatile memory (NVM).

Name	0x33	TRIM_NVM_CTRL		
Bit	7	6	5	4
Read/Write	R	R	R	R
Reset Value	n/a	n/a	n/a	n/a
Content	nvm_remain<3:0>			
Bit	3	2	1	0
Read/Write	R/W	R	W	R/W
Reset Value	0	n/a	0	0
Content	nvm_load	nvm_rdy	nvm_prog_trig	nvm_prog_mode

nvm_remain<3:0>: number of remaining write cycles permitted for NVM; the number is decremented each time a write to the NVM is triggered

nvm_load: '1' → trigger, or '0' → do not trigger an update of all configuration registers from NVM; the nvm_rdy flag must be '1' prior to triggering the update

nvm_rdy: status of NVM controller: '0' → NVM write / NVM update operation is in progress, '1' → NVM is ready to accept a new write or update trigger

nvm_prog_trig: '1' → trigger, or '0' → do not trigger an NVM write operation; the trigger is only accepted if the NVM was unlocked before and nvm_remain<3:0> is greater than '0'; flag nvm_rdy must be '1' prior to triggering the write cycle

nvm_prog_mode: '1' → unlock, or '0' → lock NVM write operation

 BOSCH	BMA223 Preliminary data sheet	Page 87 Confidential
--	---	-------------------------

Register 0x34 (BGW_SPI3_WDT)

Contains settings for the digital interfaces.

Name	0x34	BGW_SPI3_WDT		
Bit	7	6	5	4
Read/Write	R/W	R/W	R/W	R/W
Reset Value	0	0	0	0
Content	reserved			

Bit	3	2	1	0
Read/Write	R/W	R/W	R/W	R/W
Reset Value	0	0	0	0
Content	reserved	i2c_wdt_en	i2c_wdt_sel	spi3

reserved: write '0'

i2c_wdt_en: if I²C interface mode is selected then '1' → enable, or '0' → disables the watchdog at the SDI pin (= SDA for I²C)

i2c_wdt_sel: select an I²C watchdog timer period of '0' → 1 ms, or '1' → 50 ms

spi3: select '0' → 4-wire SPI, or '1' → 3-wire SPI mode

 BOSCH	BMA223 Preliminary data sheet	Page 88 Confidential
--	---	-------------------------

Register 0x36 (OFC_CTRL)

Contains control signals and configuration settings for the fast and the slow offset compensation.

Name	0x36	OFC_CTRL		
Bit	7	6	5	4
Read/Write	W	W	W	R
Reset Value	0	0	0	0
Content	offset_reset	cal_trigger<1:0>		cal_rdy

Bit	3	2	1	0
Read/Write	R/W	R/W	R/W	R/W
Reset Value	0	0	0	0
Content	reserved	hp_z_en	hp_y_en	hp_x_en

offset_reset: '1' → set all offset compensation registers (0x38 to 0x3A) to zero, or '0' → keep their values

offset_trigger<1:0>: trigger fast compensation for '01b' → x-axis, '10b' → y-axis, or '11b' → z-axis; '00b' → do not trigger offset compensation; offset compensation must not be triggered when cal_rdy is '0'

cal_rdy: indicates the state of the fast compensation: '0' → offset compensation is in progress, or '1' → offset compensation is ready to be retrigged

reserved: write '0'

hp_z_en: '1' → enable, or '0' → disable slow offset compensation for the z-axis

hp_y_en: '1' → enable, or '0' → disable slow offset compensation for the y-axis

hp_x_en: '1' → enable, or '0' → disable slow offset compensation for the x-axis

 BOSCH	BMA223 Preliminary data sheet	Page 89 Confidential
--	---	-------------------------

Register 0x37 (OFC_SETTING)

Contains configuration settings for the fast and the slow offset compensation.

Name	0x37	OFC_SETTING		
Bit	7	6	5	4
Read/Write	R/W	R/W	R/W	R/W
Reset Value	0	0	0	0
Content	reserved	offset_target_z<1:0>		offset_target_y<1>
				>
Bit	3	2	1	0
Read/Write	R/W	R/W	R/W	R/W
Reset Value	0	0	0	0
Content	offset_target_y<0>	offset_target_x<1:0>		cut_off
	>			

reserved: write '0'

offset_target_z<1:0>: offset compensation target value for z-axis is '00b' → 0 g, '01b' → +1 g, '10b' → -1 g, or '11b' → 0 g

offset_target_y<1:0>: offset compensation target value for y-axis is '00b' → 0 g, '01b' → +1 g, '10b' → -1 g, or '11b' → 0 g

offset_target_x<1:0>: offset compensation target value for x-axis is '00b' → 0 g, '01b' → +1 g, '10b' → -1 g, or '11b' → 0 g

cut_off: select '0' → 1 Hz, or '1' → 10 Hz cut-off frequency for slow offset compensation high-pass filter

 BOSCH	BMA223 Preliminary data sheet	Page 90 Confidential
--	---	-------------------------

Register 0x38 (OFC_OFFSET_X)

Contains the offset compensation value for x-axis acceleration readout data.

Name	0x38	OFC_OFFSET_X		
Bit	7	6	5	4
Read/Write	R/W	R/W	R/W	R/W
Reset Value	0	0	0	0
Content	offset_x<7:4>			

Bit	3	2	1	0
Read/Write	R/W	R/W	R/W	R/W
Reset Value	0	0	0	0
Content	offset_x<3:0>			

offset_x<7:0>: offset value, which is subtracted from the internal filtered and unfiltered x-axis acceleration data; the offset value is represented with two's complement notation, with a mapping of +127 → +0.992g, 0 → 0 g, and -128 → -1 g; the scaling is independent of the selected g-range; the content of the offset_x<7:0> may be written to the NVM; it is automatically restored from the NVM after each power-on or softreset; offset_x<7:0> may be written directly by the user; it is generated automatically after triggering the fast offset compensation procedure for the x-axis

 BOSCH	BMA223 Preliminary data sheet	Page 91 Confidential
--	---	-------------------------

Register 0x39 (OFC_OFFSET_Y)

Contains the offset compensation value for y-axis acceleration readout data.

Name	0x39	OFC_OFFSET_Y		
Bit	7	6	5	4
Read/Write	R/W	R/W	R/W	R/W
Reset Value	0	0	0	0
Content	offset_y<7:4>			

Bit	3	2	1	0
Read/Write	R/W	R/W	R/W	R/W
Reset Value	0	0	0	0
Content	offset_y<3:0>			

offset_y<7:0>: offset value, which is subtracted from the internal filtered and unfiltered y-axis acceleration data; the offset value is represented with two's complement notation, with a mapping of +127 → +0.992g, 0 → 0 g, and -128 → -1 g; the scaling is independent of the selected g-range; the content of the offset_y<7:0> may be written to the NVM; it is automatically restored from the NVM after each power-on or softreset; offset_y<7:0> may be written directly by the user; it is generated automatically after triggering the fast offset compensation procedure for the y-axis

 BOSCH	BMA223 Preliminary data sheet	Page 92 Confidential
--	---	-------------------------

Register 0x3A (OFC_OFFSET_Z)

Contains the offset compensation value for z-axis acceleration readout data.

Name	0x3A	OFC_OFFSET_Z		
Bit	7	6	5	4
Read/Write	R/W	R/W	R/W	R/W
Reset Value	0	0	0	0
Content	offset_z<7:4>			

Bit	3	2	1	0
Read/Write	R/W	R/W	R/W	R/W
Reset Value	0	0	0	0
Content	offset_z<3:0>			

offset_z<7:0>: offset value, which is subtracted from the internal filtered and unfiltered z-axis acceleration data; the offset value is represented with two's complement notation, with a mapping of +127 → +0.992g, 0 → 0 g, and -128 → -1 g; the scaling is independent of the selected g-range; the content of the offset_z<7:0> may be written to the NVM; it is automatically restored from the NVM after each power-on or softreset; offset_z<7:0> may be written directly by the user; it is generated automatically after triggering the fast offset compensation procedure for the z-axis

Register 0x3B (TRIM_GP0)

Contains general purpose data register with NVM back-up.

Name	0x3B	TRIM_GP0		
Bit	7	6	5	4
Read/Write	R/W	R/W	R/W	R/W
Reset Value	0	0	0	0
Content	GP0<7:4>			

Bit	3	2	1	0
Read/Write	R/W	R/W	R/W	R/W
Reset Value	0	0	0	0
Content	GP0<3:0>			

GP0<7:0>: general purpose NVM image register not linked to any sensor-specific functionality; register may be written to NVM and is restored after each power-up or softreset

 BOSCH	BMA223 Preliminary data sheet	Page 93 Confidential
--	---	-------------------------

Register 0x3C (TRIM_GP1)

Contains general purpose data register with NVM back-up.

Name	0x3C	TRIM_GP1		
Bit	7	6	5	4
Read/Write	R/W	R/W	R/W	R/W
Reset Value	0	0	0	0
Content	GP1<7:4>			

Bit	3	2	1	0
Read/Write	R/W	R/W	R/W	R/W
Reset Value	0	0	0	0
Content	GP1<3:0>			

GP1<7:0>: general purpose NVM image register not linked to any sensor-specific functionality; register may be written to NVM and is restored after each power-up or softreset

 BOSCH	BMA223 Preliminary data sheet	Page 94 Confidential
--	---	-------------------------

Register 0x3E (FIFO_CONFIG_1)

Contains FIFO configuration settings. The FIFO buffer memory is cleared and the fifo-full flag is cleared when writing to FIFO_CONFIG_1 register.

Name	0x3E	FIFO_CONFIG_1		
Bit	7	6	5	4
Read/Write	R/W	R/W	R/W	R/W
Reset Value	0	0	0	0
Content	fifo_mode<1:0>		Reserved	
Bit	3	2	1	0
Read/Write	R/W	R/W	R/W	R/W
Reset Value	0	0	0	0
Content	Reserved		fifo_data_select<1:0>	

fifo_mode<1:0>: selects the FIFO operating mode:

- '00b' → BYPASS (buffer depth of 1 frame; old data is discarded),
- '01b' → FIFO (data collection stops when buffer is filled with 32 frames),
- '10b' → STREAM (sampling continues when buffer is full; old is discarded),
- '11b' → reserved, do not use

fifo_data_select<1:0>: selects whether '00b' → X+Y+Z, '01b' → X only, '10b' → Y only, '11b' → Z only acceleration data are stored in the FIFO

 BOSCH	BMA223 Preliminary data sheet	Page 95 Confidential
--	---	-------------------------

Register 0x3F (FIFO_DATA)

FIFO data readout register. The format of the LSB and MSB components corresponds to that of the acceleration data readout registers. The new data flag is preserved. Read burst access may be used since the address counter will not increment when the read burst is started at the address of FIFO_DATA. The entire frame is discarded when a frame is only partially read out.

Name	0x3F	FIFO_DATA		
Bit	7	6	5	4
Read/Write	R	R	R	R
Reset Value	n/a	n/a	n/a	n/a
Content	fifo_data_output_register<7:4>			

Bit	3	2	1	0
Read/Write	R	R	R	R
Reset Value	n/a	n/a	n/a	n/a
Content	fifo_data_output_register<3:0>			

fifo_data_output_register<7:0>: FIFO data readout; data format depends on the setting of register fifo_data_select<1:0>:

if X+Y+Z data are selected, the data of frame n is reading out in the order of X-lsb(n), X-msb(n), Y-lsb(n), Y-msb(n), Z-lsb(n), Z-msb(n);
if X-only is selected, the data of frame n and n+1 are reading out in the order of X-lsb(n), X-msb(n), X-lsb(n+1), X-msb(n+1); the Y-only and Z-only modes behave analogously

 BOSCH	BMA223 Preliminary data sheet	Page 96 Confidential
--	---	-------------------------

7. Digital interfaces

The BMA223 supports two serial digital interface protocols for communication as a slave with a host device (when operating in general mode): SPI and I²C. The active interface is selected by the state of the Pin#11 (PS) 'protocol select' pin: '0' ('1') selects SPI (I²C). For details please refer to section 8).

By default, SPI operates in the standard 4-wire configuration. It can be re-configured by software to work in 3-wire mode instead of standard 4-wire mode.

Both interfaces share the same pins. The mapping for each interface is given in the following table:

Table 20: Mapping of the interface pins

Pin#	Name	use w/ SPI	use w/ I ² C	Description
1	SDO	SDO	address	SPI: Data Output (4-wire mode) I ² C: Used to set LSB of I ² C address
2	SDx	SDI	SDA	SPI: Data Input (4-wire mode) Data Input / Output (3-wire mode) I ² C: Serial Data
10	CSB	CSB	unused	Chip Select (enable)
12	SCx	SCK	SCL	SPI: Serial Clock I ² C: Serial Clock

The following table shows the electrical specifications of the interface pins:

Table 21: Electrical specification of the interface pins

Parameter	Symbol	Condition	Min	Typ	Max	Units
Pull-up Resistance, CSB pin	R _{up}	Internal Pull-up Resistance to VDDIO	75	100	125	kΩ
Input Capacitance	C _{in}			5	10	pF
I ² C Bus Load Capacitance (max. drive capability)	C _{I2C_Load}				400	pF

 BOSCH	BMA223 Preliminary data sheet	Page 97 Confidential
--	---	-------------------------

7.1 Serial peripheral interface (SPI)

The timing specification for SPI of the BMA223 is given in the following table:

Table 22: SPI timing

Parameter	Symbol	Condition	Min	Max	Units
Clock Frequency	f_{SPI}	Max. Load on SDI or SDO = 25pF, $V_{\text{DDIO}} \geq 1.62\text{V}$		10	MHz
		$V_{\text{DDIO}} < 1.62\text{V}$		7.5	MHz
SCK Low Pulse	t_{SCKL}		20		ns
SCK High Pulse	t_{SCKH}		20		ns
SDI Setup Time	$t_{\text{SDI_setup}}$		20		ns
SDI Hold Time	$t_{\text{SDI_hold}}$		20		ns
SDO Output Delay	$t_{\text{SDO_OD}}$	Load = 25pF, $V_{\text{DDIO}} \geq 1.62\text{V}$		30	ns
		Load = 25pF, $V_{\text{DDIO}} < 1.62\text{V}$		50	ns
		Load = 250pF, $V_{\text{DDIO}} > 2.4\text{V}$		40	ns
CSB Setup Time	$t_{\text{CSB_setup}}$		20		ns
CSB Hold Time	$t_{\text{CSB_hold}}$		40		ns
Idle time between write accesses, normal mode, standby mode, low-power mode 2	$t_{\text{IDLE_wacc_nm}}$		2		μs
Idle time between write accesses, suspend mode, low-power mode 1	$t_{\text{IDLE_wacc_sum}}$		450		μs

 BOSCH	BMA223 Preliminary data sheet	Page 98 Confidential
--	---	-------------------------

The following figure shows the definition of the SPI timings given in the following figure:

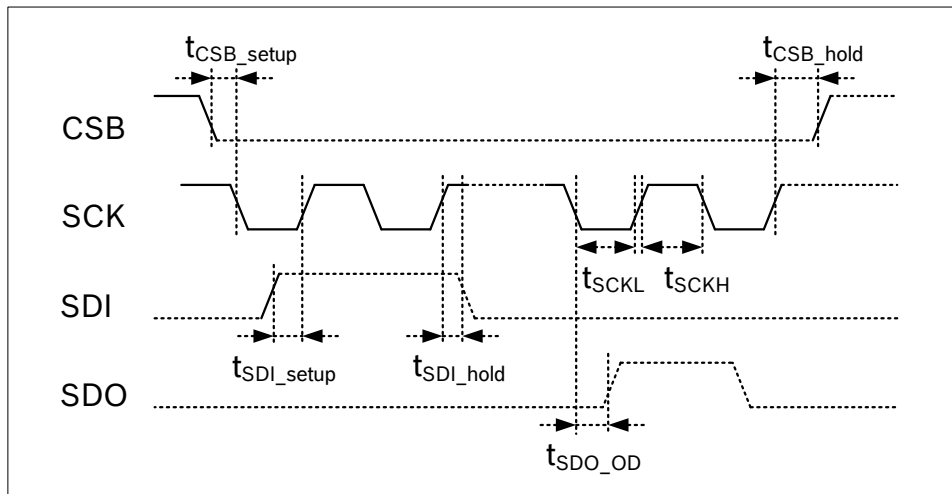



Figure 13: SPI timing diagram

The SPI interface of the BMA223 is compatible with two modes, '00' and '11'. The automatic selection between [CPOL = '0' and CPHA = '0'] and [CPOL = '1' and CPHA = '1'] is controlled based on the value of SCK after a falling edge of CSB.

Two configurations of the SPI interface are supported by the BMA223: 4-wire and 3-wire. The same protocol is used by both configurations. The device operates in 4-wire configuration by default. It can be switched to 3-wire configuration by writing '1' to (0x34) spi3. Pin SDI is used as the common data pin in 3-wire configuration.

For single byte read as well as write operations, 16-bit protocols are used. The BMA223 also supports multiple-byte read operations.

In SPI 4-wire configuration CSB (chip select low active), SCK (serial clock), SDI (serial data input), and SDO (serial data output) pins are used. The communication starts when the CSB is pulled low by the SPI master and stops when CSB is pulled high. SCK is also controlled by SPI master. SDI and SDO are driven at the falling edge of SCK and should be captured at the rising edge of SCK.

 BOSCH	BMA223 Preliminary data sheet	Page 99 Confidential
--	---	-------------------------

The basic write operation waveform for 4-wire configuration is depicted in figure 14. During the entire write cycle SDO remains in high-impedance state.

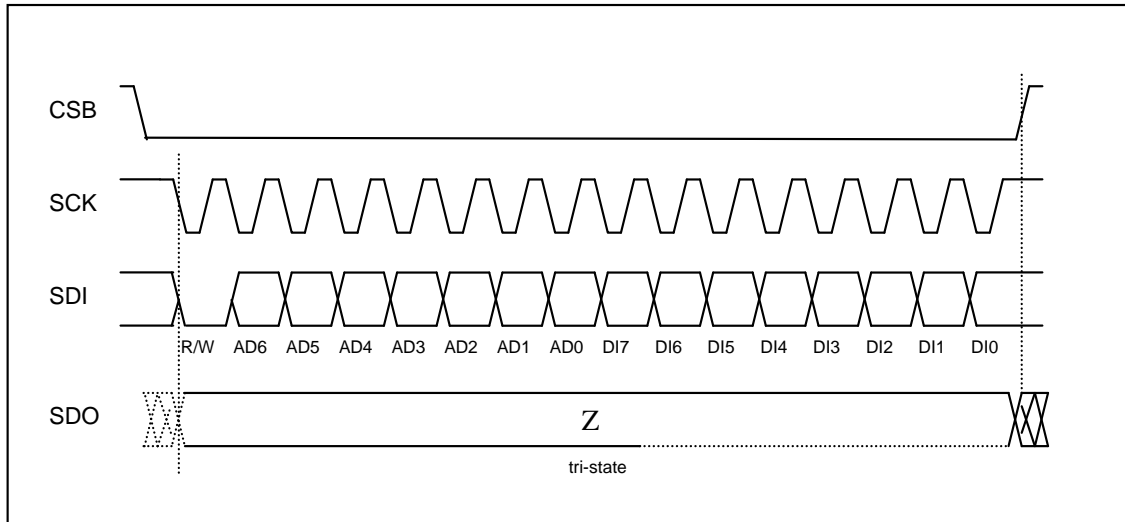

Figure 14: 4-wire basic SPI write sequence (mode '11')

The basic read operation waveform for 4-wire configuration is depicted in figure 15:

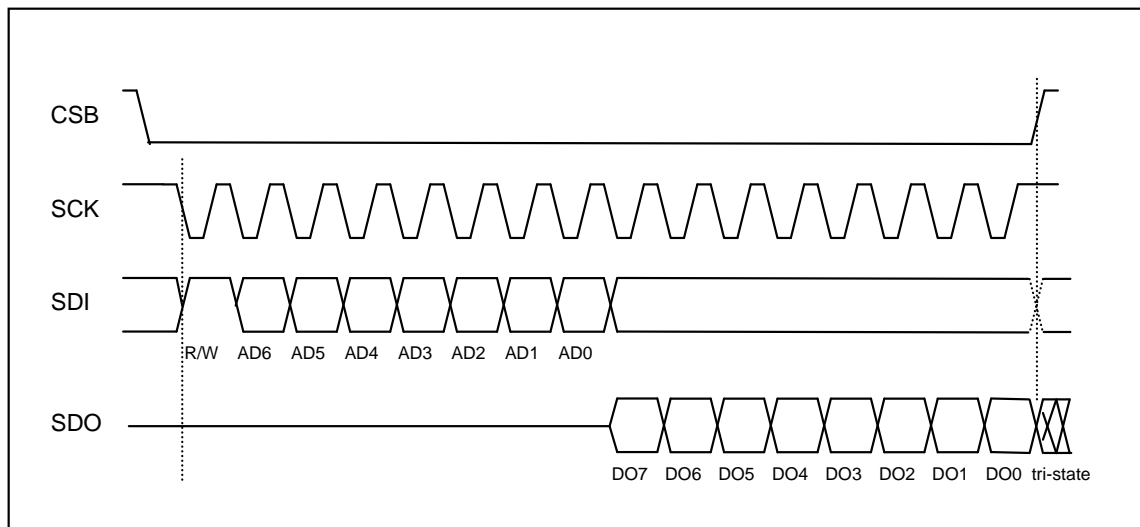



Figure 15: 4-wire basic SPI read sequence (mode '11')

 BOSCH	BMA223 Preliminary data sheet	Page 101 Confidential
--	---	--------------------------

7.2 Inter-Integrated Circuit (I²C)

The I²C bus uses SCL (= SCx pin, serial clock) and SDA (= SDx pin, serial data input and output) signal lines. Both lines are connected to V_{DDIO} externally via pull-up resistors so that they are pulled high when the bus is free.

The I²C interface of the BMA223 is compatible with the I²C Specification UM10204 Rev. 03 (19 June 2007), available at <http://www.nxp.com>. The BMA223 supports I²C standard mode and fast mode, only 7-bit address mode is supported. For V_{DDIO} = 1.2V to 1.8V the guaranteed voltage output levels are slightly relaxed as described in the Parameter Specification (Table 1).

The default I²C address of the device is 0011000b (0x18). It is used if the SDO pin is pulled to 'GND'. The alternative address 0011001b (0x19) is selected by pulling the SDO pin to 'V_{DDIO}'.

The timing specification for I²C of the BMA223 is given in Table 23:

Table 23: I²C timings

Parameter	Symbol	Condition	Min	Max	Units	
Clock Frequency	f _{SCL}			400	kHz	
SCL Low Period	t _{LOW}		1.3		μs	
SCL High Period	t _{HIGH}		0.6			
SDA Setup Time	t _{SUDAT}		0.1			
SDA Hold Time	t _{HDDAT}		0.0			
Setup Time for a repeated Start Condition	t _{SUSTA}		0.6			
Hold Time for a Start Condition	t _{HDSTA}		0.6			
Setup Time for a Stop Condition	t _{SUSTO}		0.6			
Time before a new Transmission can start	t _{BUF}		1.3			
Idle time between write accesses, normal mode, standby mode, low-power mode 2	t _{IDLE wacc n m}		2			μs
Idle time between write accesses, suspend mode, low-power mode 1	t _{IDLE wacc s um}		450			μs

 BOSCH	BMA223 Preliminary data sheet	Page 102 Confidential
--	---	--------------------------

Figure 18 shows the definition of the I²C timings given in Table 23:

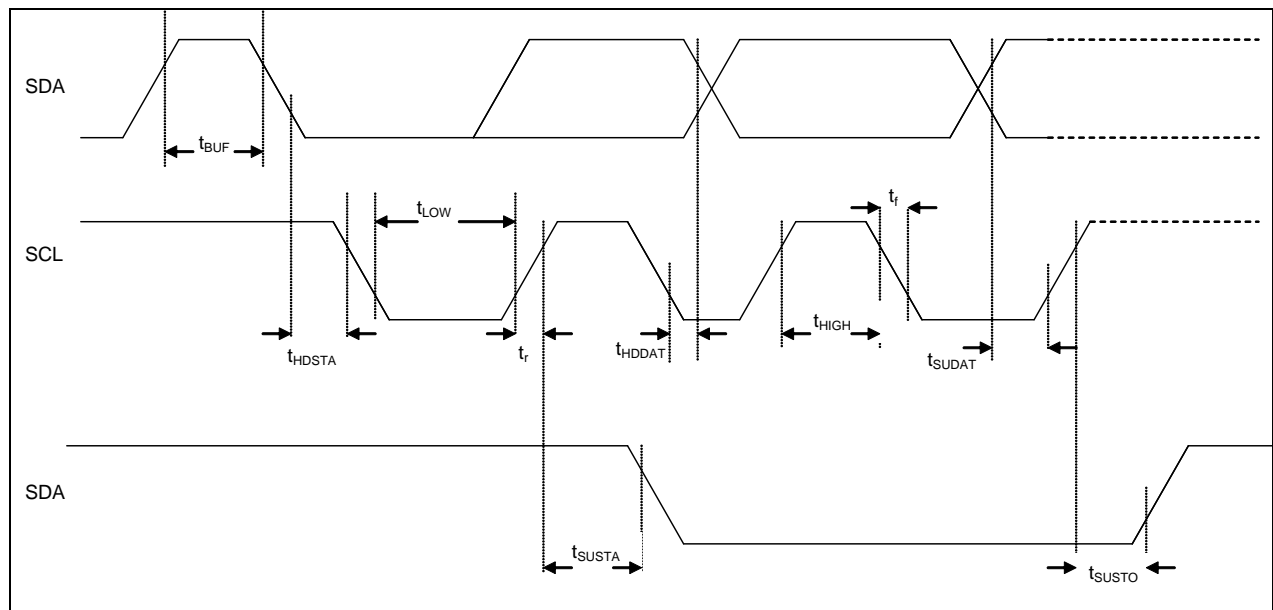

Figure 18: I²C timing diagram

The I²C protocol works as follows:

START: Data transmission on the bus begins with a high to low transition on the SDA line while SCL is held high (start condition (S) indicated by I²C bus master). Once the START signal is transferred by the master, the bus is considered busy.

STOP: Each data transfer should be terminated by a Stop signal (P) generated by master. The STOP condition is a low to HIGH transition on SDA line while SCL is held high.

ACK: Each byte of data transferred must be acknowledged. It is indicated by an acknowledge bit sent by the receiver. The transmitter must release the SDA line (no pull down) during the acknowledge pulse while the receiver must then pull the SDA line low so that it remains stable low during the high period of the acknowledge clock cycle.

In the following diagrams these abbreviations are used:

S	Start
P	Stop
ACKS	Acknowledge by slave
ACKM	Acknowledge by master
NACKM	Not acknowledge by master
RW	Read / Write

A START immediately followed by a STOP (without SCK toggling from logic "1" to logic "0") is not supported. If such a combination occurs, the STOP is not recognized by the device.

 BOSCH	BMA223 Preliminary data sheet	Page 103 Confidential
--	---	--------------------------

I²C write access:

I²C write access can be used to write a data byte in one sequence.

The sequence begins with start condition generated by the master, followed by 7 bits slave address and a write bit (RW = 0). The slave sends an acknowledge bit (ACK = 0) and releases the bus. Then the master sends the one byte register address. The slave again acknowledges the transmission and waits for the 8 bits of data which shall be written to the specified register address. After the slave acknowledges the data byte, the master generates a stop signal and terminates the writing protocol.

Example of an I²C write access:

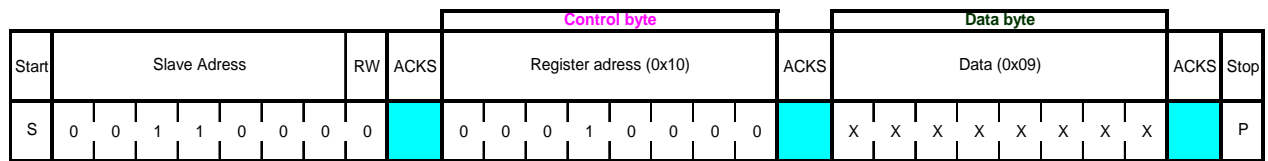

Figure 19: I²C write

I²C read access:

I²C read access also can be used to read one or multiple data bytes in one sequence.

A read sequence consists of a one-byte I²C write phase followed by the I²C read phase. The two parts of the transmission must be separated by a repeated start condition (Sr). The I²C write phase addresses the slave and sends the register address to be read. After slave acknowledges the transmission, the master generates again a start condition and sends the slave address together with a read bit (RW = 1). Then the master releases the bus and waits for the data bytes to be read out from slave. After each data byte the master has to generate an acknowledge bit (ACK = 0) to enable further data transfer. A NACKM (ACK = 1) from the master stops the data being transferred from the slave. The slave releases the bus so that the master can generate a STOP condition and terminate the transmission.

The register address is automatically incremented and, therefore, more than one byte can be sequentially read out. Once a new data read transmission starts, the start address will be set to the register address specified in the latest I²C write command. By default the start address is set at 0x00. In this way repetitive multi-bytes reads from the same starting address are possible.

In order to prevent the I²C slave of the device to lock-up the I²C bus, a watchdog timer (WDT) is implemented. The WDT observes internal I²C signals and resets the I²C interface if the bus is locked-up by the BMA223. The activity and the timer period of the WDT can be configured through the bits (0x34) *i2c_wdt_en* and (0x34) *i2c_wdt_sel*.

Writing '1' ('0') to (0x34) *i2c_wdt_en* activates (de-activates) the WDT. Writing '0' ('1') to (0x34) *i2c_wdt_se* selects a timer period of 1 ms (50 ms).

 BOSCH	BMA223 Preliminary data sheet	Page 104 Confidential
--	---	--------------------------

Example of an I²C read access:

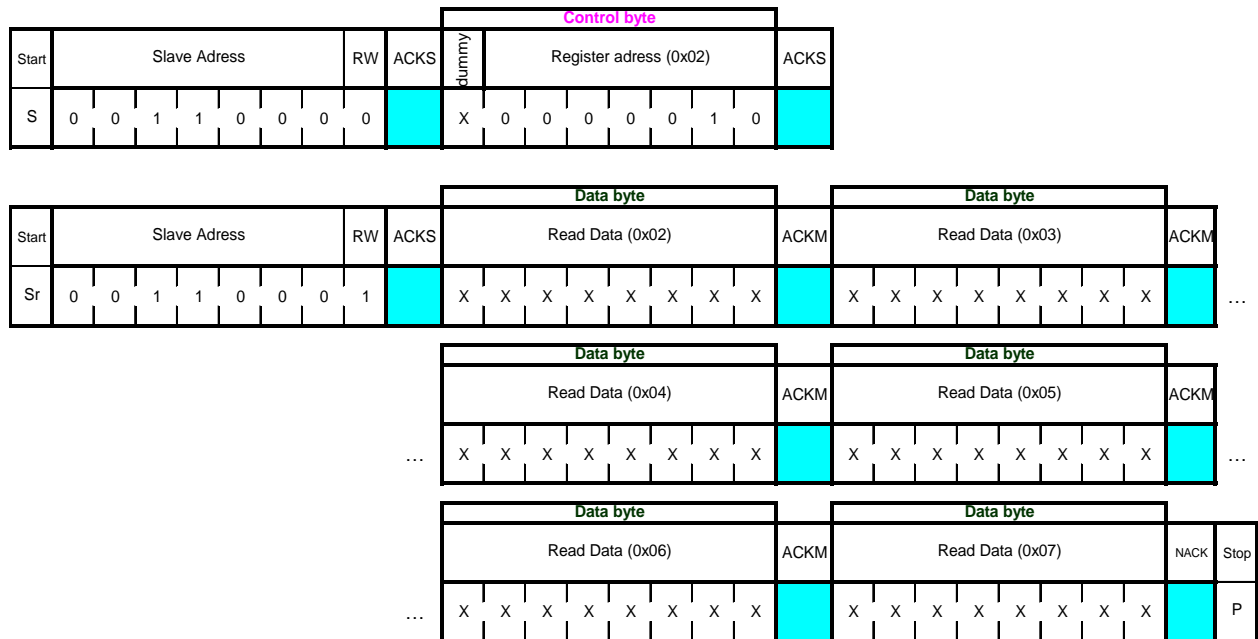

Figure 20: I²C multiple read

7.2.1 SPI and I²C Access Restrictions

In order to allow for the correct internal synchronisation of data written to the BMA223, certain access restrictions apply for consecutive write accesses or a write/read sequence through the SPI as well as I²C interface. The required waiting period depends on whether the device is operating in normal mode (or standby mode, or low-power mode 2) or suspend mode (or low-power mode 1).

As illustrated in figure 21, an interface idle time of at least 2 μ s is required following a write operation when the device operates in normal mode (or standby mode, or low-power mode 2). In suspend mode (or low-power mode 1) an interface idle time of least 450 μ s is required.

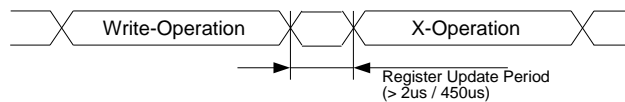



Figure 21: Post-Write Access Timing Constraints

 BOSCH	BMA223 Preliminary data sheet	Page 105 Confidential
--	---	--------------------------

8. Pin-out and connection diagram

8.1 Pin-out

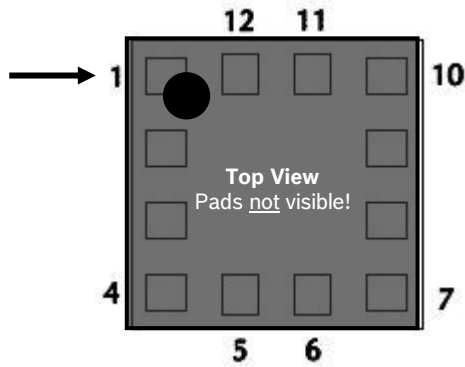

Figure 22: Pin-out top view

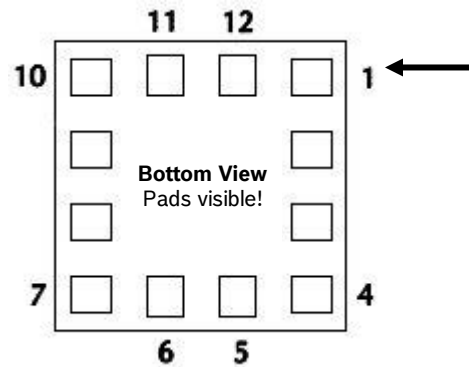



Figure 23: Pin-out bottom view

Table 24: Pin description

Pin#	Name	I/O Type	Description	Connect to		
				in SPI 4W	In SPI 3W	in I ² C
1	SDO	Digital out	Serial data output in SPI Address select in I ² C mode see chapter 7.2	SDO	DNC (float)	GND for default addr.
2	SDx	Digital I/O	SDA serial data I/O in I ² C SDI serial data input in SPI 4W SDA serial data I/O in SPI 3W	SDI	SDA	SDA
3	VDDIO	Supply	Digital I/O supply voltage (1.2V ... 3.6V)	V _{DDIO}	V _{DDIO}	V _{DDIO}
4	NC	--		GND	GND	GND
5	INT1	Digital out	Interrupt output 1 *	INT1	INT1	INT1
6	INT2	Digital out	Interrupt output 2 *	INT2	INT2	INT2
7	VDD	Supply	Power supply for analog & digital domain (1.62V ... 3.6V)	V _{DD}	V _{DD}	V _{DD}
8	GNDIO	Ground	Ground for I/O	GND	GND	GND
9	GND	Ground	Ground for digital & analog	GND	GND	GND
10	CSB	Digital in	Chip select for SPI mode	CSB	CSB	DNC (float)
11	PS	Digital in	Protocol select (GND = SPI, V _{DDIO} = I ² C)	GND	GND	V _{DDIO}
12	SCx	Digital in	SCK for SPI serial clock SCL for I ² C serial clock	SCK	SCK	SCL

* If INT1 and/or INT2 are not used, please do not connect them (DNC).

	BMA223 Preliminary data sheet	Page 106 Confidential
---	---	--------------------------

8.2 Connection diagram 4-wire SPI

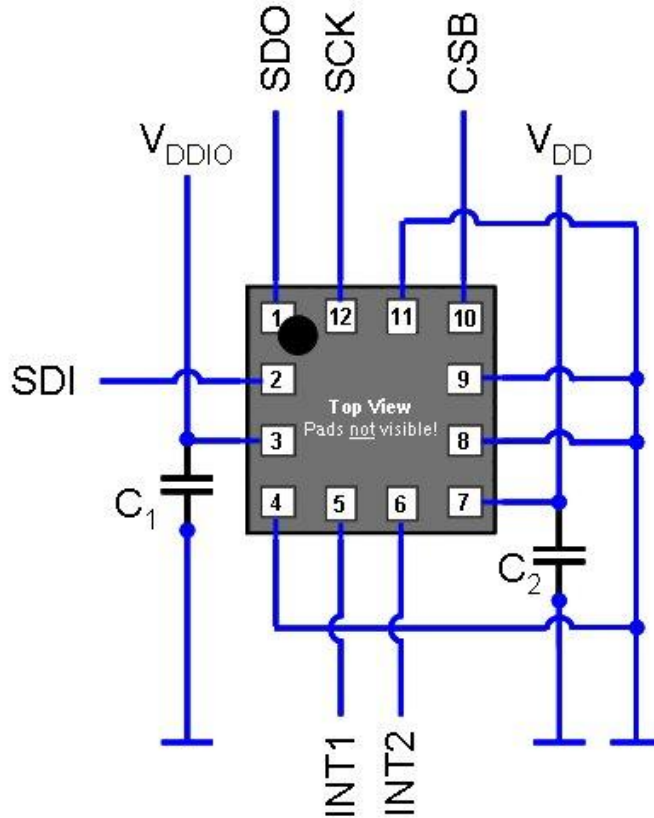



Figure 24: 4-wire SPI connection

Note: the recommended value for C_1 , C_2 is 100 nF.

	BMA223 Preliminary data sheet	Page 107 Confidential
---	---	--------------------------

8.3 Connection diagram 3-wire SPI

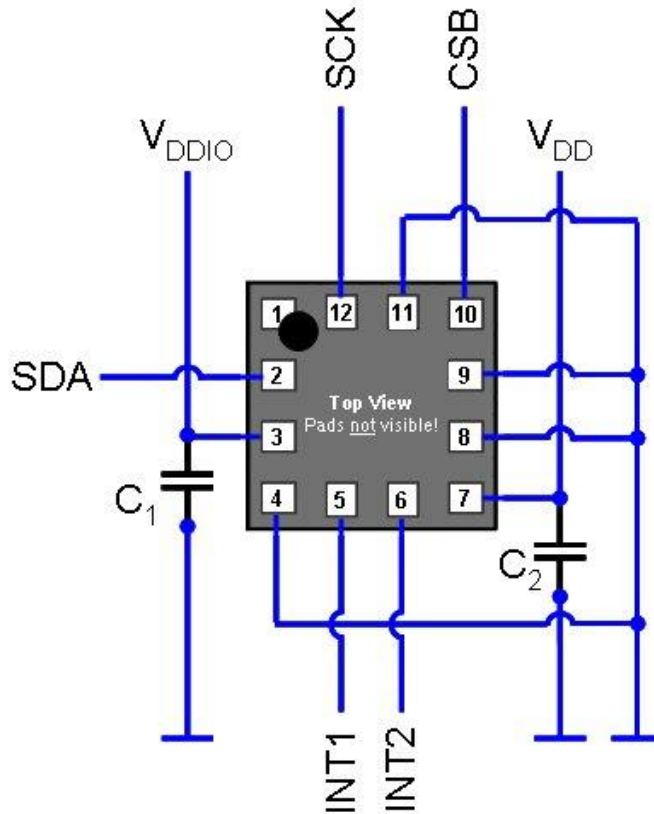



Figure 25: 3-wire SPI connection

Note: the recommended value for C_1 , C_2 is 100 nF.

 BOSCH	BMA223 Preliminary data sheet	Page 108 Confidential
--	---	--------------------------

8.4 Connection diagram I²C

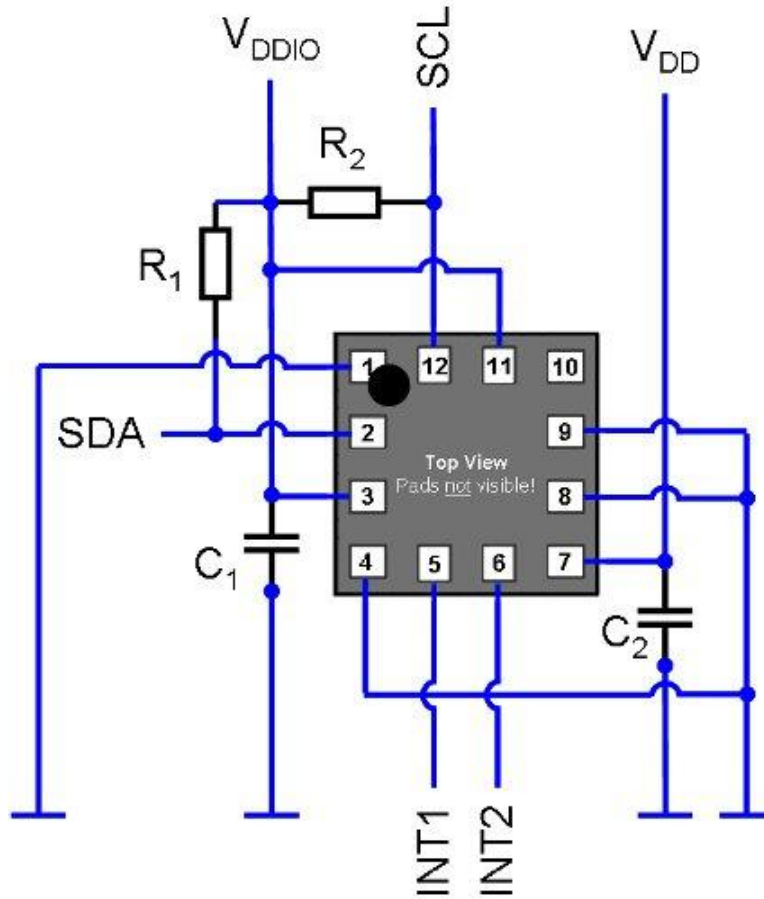



Figure 26: I²C connection

Note: the recommended value for C₁, C₂ is 100 nF.

 BOSCH	BMA223 Preliminary data sheet	Page 110 Confidential
--	---	--------------------------

9.2 Sensing axes orientation

If the sensor is accelerated in the indicated directions, the corresponding channel will deliver a positive acceleration signal (dynamic acceleration). If the sensor is at rest and the force of gravity is acting along the indicated directions, the output of the corresponding channel will be negative (static acceleration).

Example: If the sensor is at rest or at uniform motion in a gravity field according to the figure given below, the output signals are:

- $\pm 0g$ for the X channel
- $\pm 0g$ for the Y channel
- $+ 1g$ for the Z channel

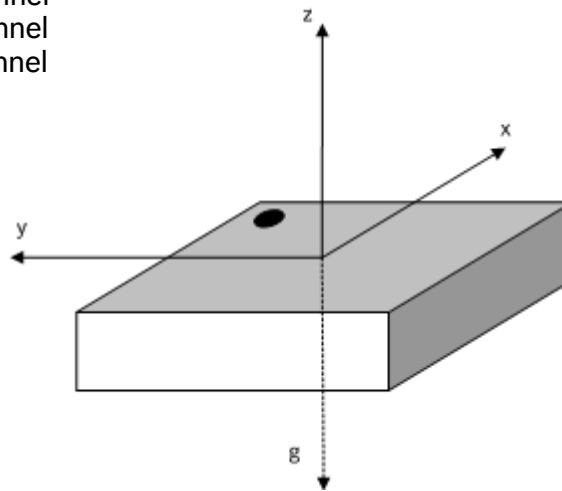



Figure 28: Orientation of sensing axis

The following table lists all corresponding output signals on X, Y, and Z while the sensor is at rest or at uniform motion in a gravity field under assumption of a $\pm 2g$ range setting and a top down gravity vector as shown above.

Table 25: Output signals depending on sensor orientation

Sensor Orientation (gravity vector ↓)					upright	
Output Signal X	0g / 0LSB	1g / 64LSB	0g / 0LSB	-1g / -64LSB	0g / 0LSB	0g / 0LSB
Output Signal Y	-1g / -64LSB	0g / 0LSB	1g / 64LSB	0g / 0LSB	0g / 0LSB	0g / 0LSB
Output Signal Z	0g / 0LSB	0g / 0LSB	0g / 0LSB	0g / 0LSB	1g / 64LSB	-1g / -64LSB

 BOSCH	BMA223 Preliminary data sheet	Page 111 Confidential
--	---	--------------------------

9.3 Landing Pattern Recommendation

The size of the land pads should be the same as the opening in the solder mask of the sensor, i.e. the landing pattern should be a mirror of the LGA package's bottom view. For the pattern of the solder paste we recommend the dimensions shown in the figure 29b.

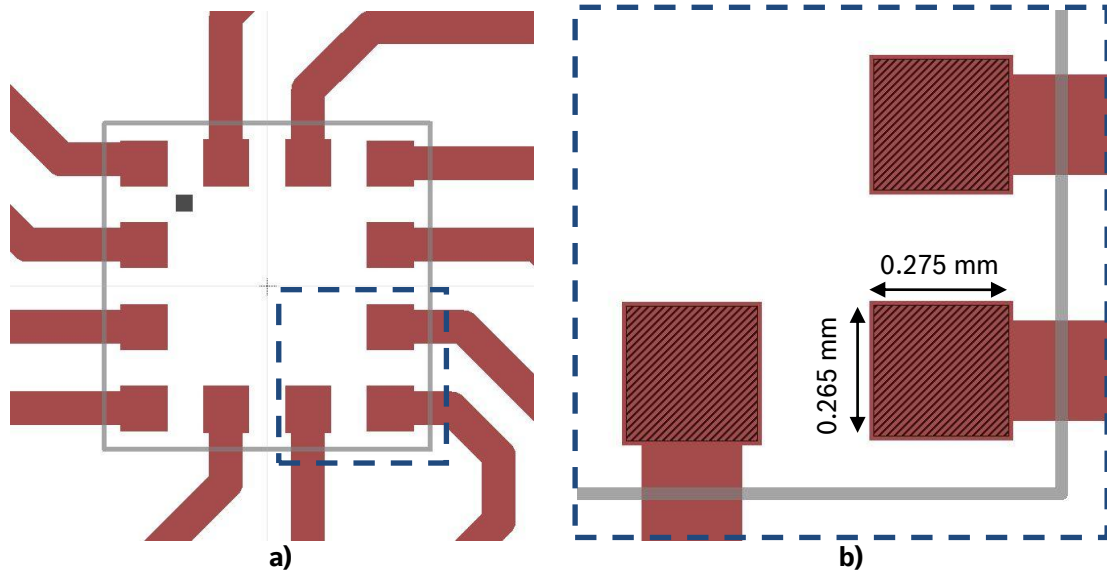



Figure 29: a) Landing patterns; b) solder paste pattern

 BOSCH	BMA223 Preliminary data sheet	Page 112 Confidential
--	---	--------------------------

9.4 Marking

9.4.1 Mass production devices

Table 26: Marking of mass production samples

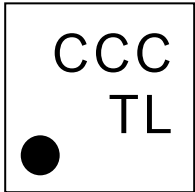
Labeling	Name	Symbol	Remark
	Lot counter	CCC	3 alphanumeric digits, variable to generate mass production trace-code
	Product number	T	1 alphanumeric digit, fixed to identify product type, T = "M"
	Sub-con ID	L	1 alphanumeric digit, variable to identify sub-con (L = "A" or L = "U" or L = "P" or L="T")
	Pin 1 identifier	●	--

9.4.2 Engineering samples

Table 27: Marking of engineering samples

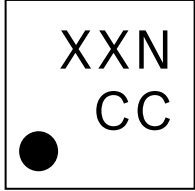
Labeling	Name	Symbol	Remark
	Eng. sample ID	N	1 alphanumeric digit, fixed to identify engineering sample, N = "*" or "e" or "E"
	Sample ID	XX	2 alphanumeric digits, variable to generate trace-code
	Counter ID	CC	2 alphanumeric digits, variable to generate trace-code
	Pin 1 identifier	●	--

 BOSCH	BMA223 Preliminary data sheet	Page 113 Confidential
--	---	--------------------------

9.5 Soldering guidelines

The moisture sensitivity level of the BMA223 sensors corresponds to JEDEC Level 1, see also

- IPC/JEDEC J-STD-020C "Joint Industry Standard: Moisture/Reflow Sensitivity Classification for non-hermetic Solid State Surface Mount Devices"
- IPC/JEDEC J-STD-033A "Joint Industry Standard: Handling, Packing, Shipping and Use of Moisture/Reflow Sensitive Surface Mount Devices"

The sensor fulfils the lead-free soldering requirements of the above-mentioned IPC/JEDEC standard, i.e. reflow soldering with a peak temperature up to 260°C.

Profile Feature	Pb-Free Assembly
Average Ramp-Up Rate (Ts _{max} to Tp)	3° C/second max.
Preheat - Temperature Min (Ts _{min}) - Temperature Max (Ts _{max}) - Time (ts _{min} to ts _{max})	150 °C 200 °C 60-180 seconds
Time maintained above: - Temperature (T _L) - Time (t _L)	217 °C 60-150 seconds
Peak/Classification Temperature (Tp)	260 °C
Time within 5 °C of actual Peak Temperature (tp)	20-40 seconds
Ramp-Down Rate	6 °C/second max.
Time 25 °C to Peak Temperature	8 minutes max.

Note 1: All temperatures refer to topside of the package, measured on the package body surface.

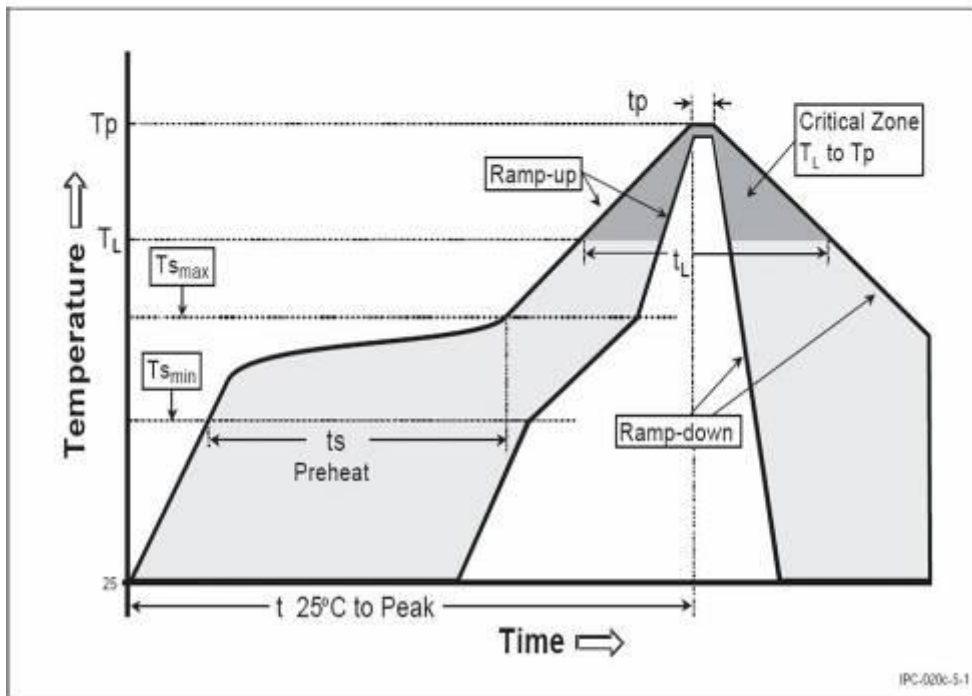



Figure 30: Soldering profile

 BOSCH	BMA223 Preliminary data sheet	Page 114 Confidential
--	---	--------------------------

9.6 Handling instructions

Micromechanical sensors are designed to sense acceleration with high accuracy even at low amplitudes and contain highly sensitive structures inside the sensor element. The MEMS sensor can tolerate mechanical shocks up to several thousand g's. However, these limits might be exceeded in conditions with extreme shock loads such as e.g. hammer blow on or next to the sensor, dropping of the sensor onto hard surfaces etc.

We recommend to avoid g-forces beyond the specified limits during transport, handling and mounting of the sensors in a defined and qualified installation process.

This device has built-in protections against high electrostatic discharges or electric fields (e.g. 2kV HBM); however, anti-static precautions should be taken as for any other CMOS component. Unless otherwise specified, proper operation can only occur when all terminal voltages are kept within the supply voltage range. Unused inputs must always be tied to a defined logic voltage level.

 BOSCH	BMA223 Preliminary data sheet	Page 115 Confidential
--	---	--------------------------

9.7 Tape and reel specification

The BMA223 is shipped in a standard cardboard box.
 The box dimension for 1 reel is: L x W x H = 35cm x 35cm x 6cm.
 BMA223 quantity: 10,000pcs per reel, please handle with care.

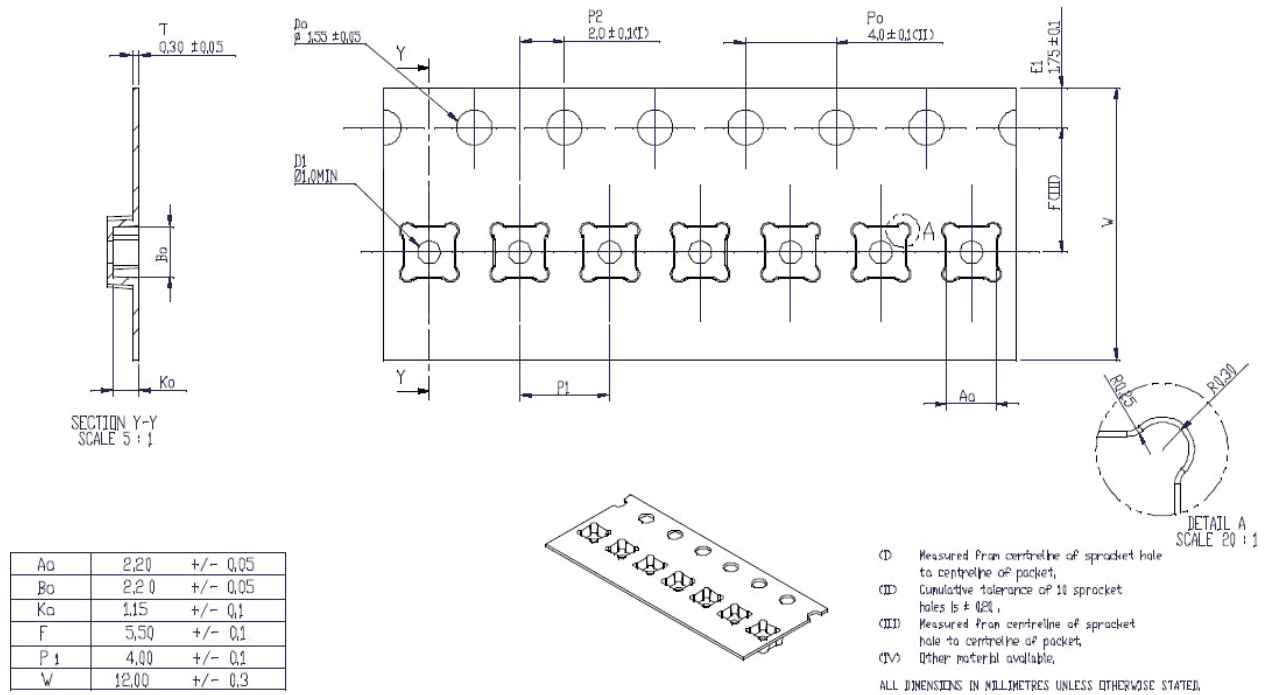



Figure 31: Tape and reel dimensions in mm

 BOSCH	BMA223 Preliminary data sheet	Page 116 Confidential
--	---	--------------------------

9.7.1 Orientation within the reel

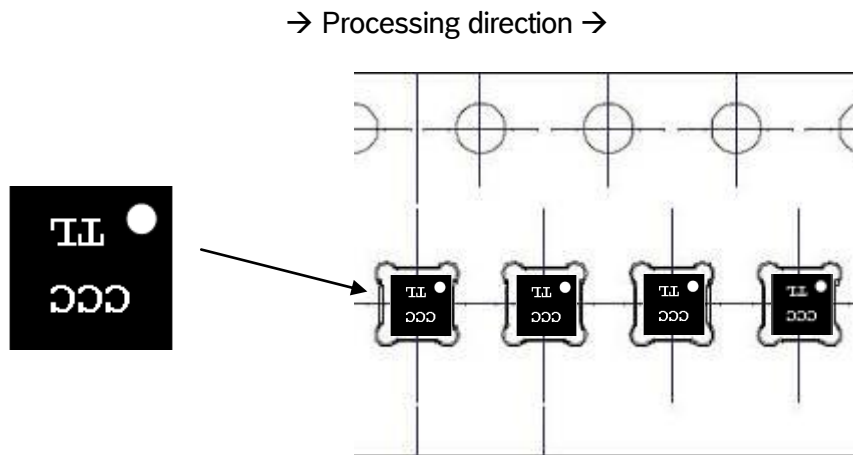



Figure 32: Orientation of the BMA223 devices relative to the tape

 BOSCH	BMA223 Preliminary data sheet	Page 117 Confidential
--	---	--------------------------

9.8 Environmental safety

The BMA223 sensor meets the requirements of the EC restriction of hazardous substances (RoHS) directive, see also:

Directive 2002/95/EC of the European Parliament and of the Council of 27 January 2003 on the restriction of the use of certain hazardous substances in electrical and electronic equipment.

9.8.1 Halogen content

The BMA223 is halogen-free. For more details on the corresponding analysis results please contact your Bosch Sensortec representative.

9.8.2 Internal package structure

Within the scope of Bosch Sensortec's ambition to improve its products and secure the mass product supply, Bosch Sensortec qualifies additional sources (e.g. 2nd source) for the LGA package of the BMA223.

While Bosch Sensortec took care that all of the technical packages parameters are described above are 100% identical for all sources, there can be differences in the chemical content and the internal structural between the different package sources.

However, as secured by the extensive product qualification process of Bosch Sensortec, this has no impact to the usage or to the quality of the BMA223 product.

 BOSCH	BMA223 Preliminary data sheet	Page 118 Confidential
--	---	--------------------------

10. Legal disclaimer

10.1 Engineering samples

Engineering Samples are marked with an asterisk (*) or (e) or (E). Samples may vary from the valid technical specifications of the product series contained in this data sheet. They are therefore not intended or fit for resale to third parties or for use in end products. Their sole purpose is internal client testing. The testing of an engineering sample may in no way replace the testing of a product series. Bosch Sensortec assumes no liability for the use of engineering samples. The Purchaser shall indemnify Bosch Sensortec from all claims arising from the use of engineering samples.

10.2 Product use

Bosch Sensortec products are developed for the consumer goods industry. They may only be used within the parameters of this product data sheet. They are not fit for use in life-sustaining or security sensitive systems. Security sensitive systems are those for which a malfunction is expected to lead to bodily harm or significant property damage. In addition, they are not fit for use in products which interact with motor vehicle systems.

The resale and/or use of products are at the purchaser's own risk and his own responsibility. The examination of fitness for the intended use is the sole responsibility of the Purchaser.

The purchaser shall indemnify Bosch Sensortec from all third party claims arising from any product use not covered by the parameters of this product data sheet or not approved by Bosch Sensortec and reimburse Bosch Sensortec for all costs in connection with such claims.

The purchaser must monitor the market for the purchased products, particularly with regard to product safety, and inform Bosch Sensortec without delay of all security relevant incidents.

10.3 Application examples and hints

With respect to any examples or hints given herein, any typical values stated herein and/or any information regarding the application of the device, Bosch Sensortec hereby disclaims any and all warranties and liabilities of any kind, including without limitation warranties of non-infringement of intellectual property rights or copyrights of any third party. The information given in this document shall in no event be regarded as a guarantee of conditions or characteristics. They are provided for illustrative purposes only and no evaluation regarding infringement of intellectual property rights or copyrights or regarding functionality, performance or error has been made.

 BOSCH	BMA223 Preliminary data sheet	Page 119 Confidential
--	---	--------------------------

11. Document history and modification

Rev. No	Chapter	Description of modification/changes	Date
0.1		Initial internal release	01 March 2013
0.2		Internal revision, not for release	
0.3		Internal revision, not for release	
0.4		Internal revision, not for release	
0.5		Internal revision, not for release	
0.6		Internal revision, not for release	
0.7		Initial customer release	04 April 2013

Bosch Sensortec GmbH
Gerhard-Kindler-Strasse 8
72770 Reutlingen / Germany

contact@bosch-sensortec.com
www.bosch-sensortec.com

Modifications reserved | Printed in Germany
Specifications subject to change without notice
Document number: BST-BMA223-DS000-00
Revision_0.7_April 2013