

KA79XX/KA79XXA

3-Terminal 1A Negative Voltage Regulator

Features

- Output Current in Excess of 1A
- Output Voltages of -5, -6, -8, -9, -10, -12, -15, -18, -24V
- Internal Thermal Overload Protection
- Short Circuit Protection
- Output Transistor Safe Operating Area Compensation

Description

The KA79XX/KA79XXA series of three-terminal negative regulators are available in TO-220 package and with several fixed output voltages, making them useful in a wide range of applications. Each type employs internal current limiting, thermal shutdown and safe operating area protection, making it essentially indestructible.

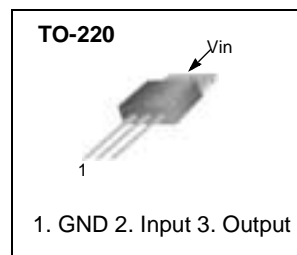

Internal Block Diagram

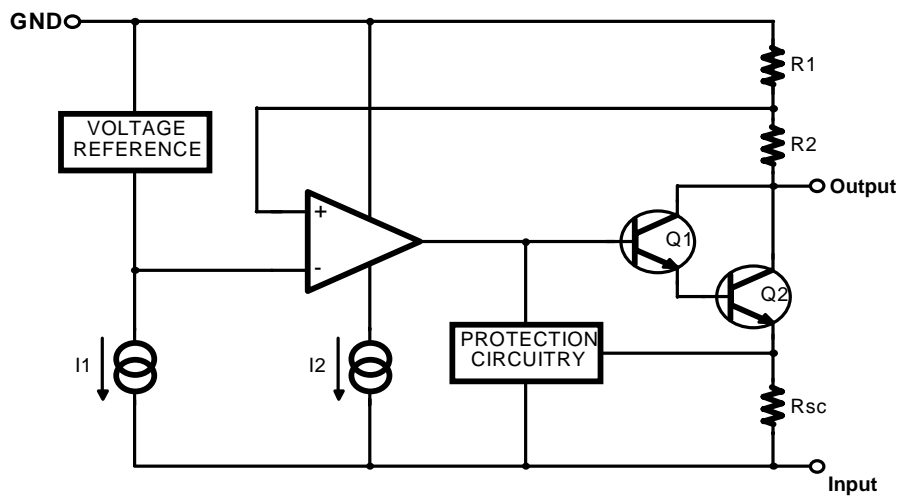

Absolute Maximum Ratings

Parameter	Symbol	Value	Unit
Input Voltage	V_I	-35	V
Thermal Resistance Junction-Case (Note1)	$R_{\theta JC}$	5	$^{\circ}\text{C}/\text{W}$
Thermal Resistance Junction-Air (Note1, 2)	$R_{\theta JA}$	65	$^{\circ}\text{C}/\text{W}$
Operating Temperature Range	TOPR	0 ~ +125	$^{\circ}\text{C}$
Storage Temperature Range	TSTG	- 65 ~ +150	$^{\circ}\text{C}$

Note:

- Thermal resistance test board
Size: 76.2mm * 114.3mm * 1.6mm(1S0P)
JEDEC standard: JESD51-3, JESD51-7
- Assume no ambient airflow

Electrical Characteristics (KA7905)

($V_I = -10\text{V}$, $I_O = 500\text{mA}$, $0^{\circ}\text{C} \leq T_J \leq +125^{\circ}\text{C}$, $C_I = 2.2\mu\text{F}$, $C_O = 1\mu\text{F}$, unless otherwise specified.)

Parameter	Symbol	Conditions	Min.	Typ.	Max.	Unit	
Output Voltage	V_O	$T_J = +25^{\circ}\text{C}$	-4.8	-5.0	-5.2	V	
		$I_O = 5\text{mA}$ to 1A, $P_O \leq 15\text{W}$ $V_I = -7\text{V}$ to -20V	-4.75	-5.0	-5.25		
Line Regulation (Note3)	ΔV_O	$T_J = +25^{\circ}\text{C}$	$V_I = -7\text{V}$ to -25V	-	35	100	mV
			$V_I = -8\text{V}$ to -12V	-	8	50	
Load Regulation (Note3)	ΔV_O	$T_J = +25^{\circ}\text{C}$, $I_O = 5\text{mA}$ to 1.5A	-	10	100	mV	
		$T_J = +25^{\circ}\text{C}$, $I_O = 250\text{mA}$ to 750mA	-	3	50		
Quiescent Current	I_Q	$T_J = +25^{\circ}\text{C}$	-	3	6	mA	
Quiescent Current Change	ΔI_Q	$I_O = 5\text{mA}$ to 1A	-	0.05	0.5	mA	
		$V_I = -8\text{V}$ to -25V	-	0.1	0.8		
Temperature Coefficient of V_D	$\Delta V_O/\Delta T$	$I_O = 5\text{mA}$	-	-0.4	-	mV/ $^{\circ}\text{C}$	
Output Noise Voltage	V_N	$f = 10\text{Hz}$ to 100kHz, $T_A = +25^{\circ}\text{C}$	-	40	-	μV	
Ripple Rejection	RR	$f = 120\text{Hz}$, $\Delta V_I = 10\text{V}$	54	60	-	dB	
Dropout Voltage	V_D	$T_J = +25^{\circ}\text{C}$, $I_O = 1\text{A}$	-	2	-	V	
Short Circuit Current	ISC	$T_J = +25^{\circ}\text{C}$, $V_I = -35\text{V}$	-	300	-	mA	
Peak Current	IPK	$T_J = +25^{\circ}\text{C}$	-	2.2	-	A	

Note

- Load and line regulation are specified at constant junction temperature. Changes in V_O due to heating effects must be taken into account separately. Pulse testing with low duty is used.

Electrical Characteristics (KA7906) (Continued)(V_I = -11V, I_O = 500mA, 0°C ≤ T_J ≤ +125°C, C_I = 2.2μF, C_O = 1μF, unless otherwise specified.)

Parameter	Symbol	Conditions	Min.	Typ.	Max.	Unit	
Output Voltage	V _O	T _J = +25°C	-5.75	-6	-6.25	V	
		I _O = 5mA to 1A, P _O ≤ 15W V _I = -9V to -21V	-5.7	-6	-6.3		
Line Regulation (Note1)	ΔV _O	T _J = +25°C	V _I = -8V to -25V	-	10	120	mV
			V _I = -9V to -13V	-	5	60	
Load Regulation (Note1)	ΔV _O	T _J = +25°C, I _O = 5mA to 1.5A	-	10	120	mV	
		T _J = +25°C, I _O = 250mA to 750mA	-	3	60		
Quiescent Current	I _Q	T _J = +25°C	-	3	6	mA	
Quiescent Current Change	ΔI _Q	I _O = 5mA to 1A	-	0.05	0.5	mA	
		V _I = -8V to -25V	-	0.1	1.3		
Temperature Coefficient of V _D	ΔV _O /ΔT	I _O = 5mA	-	-0.5	-	mV/°C	
Output Noise Voltage	V _N	f = 10Hz to 100kHz, T _A = +25°C	-	130	-	μV	
Ripple Rejection	RR	f = 120Hz, ΔV _I = 10V	54	60	-	dB	
Dropout Voltage	V _D	T _J = +25°C, I _O = 1A	-	2	-	V	
Short Circuit Current	I _{SC}	T _J = +25°C, V _I = -35V	-	300	-	mA	
Peak Current	I _{PK}	T _J = +25°C	-	2.2	-	A	

Note

1. Load and line regulation are specified at constant junction temperature. Changes in V_O due to heating effects must be taken into account separately. Pulse testing with low duty is used.

Electrical Characteristics (KA7908) (Continued)(V_I = -14V, I_O = 500mA, 0°C ≤ T_J ≤ +125°C, C_I = 2.2μF, C_O = 1μF, unless otherwise specified.)

Parameter	Symbol	Conditions	Min.	Typ.	Max.	Unit	
Output Voltage	V _O	T _J = +25°C	-7.7	-8	-8.3	V	
		I _O = 5mA to 1A, P _O ≤ 15W V _I = -10V to -23V	-7.6	-8	-8.4		
Line Regulation (Note1)	ΔV _O	T _J = +25°C	V _I = -10.5V to -25V	-	10	160	mV
			V _I = -11V to -17V	-	5	80	
Load Regulation (Note1)	ΔV _O	T _J = +25°C, I _O = 5mA to 1.5A		-	12	160	mV
		T _J = +25°C, I _O = 250mA to 750mA		-	4	80	
Quiescent Current	I _Q	T _J = +25°C	-	3	6	mA	
Quiescent Current Change	ΔI _Q	I _O = 5mA to 1A		-	0.05	0.5	mA
		V _I = -10.5V to -25V		-	0.1	1	
Temperature Coefficient of V _D	ΔV _O /ΔT	I _O = 5mA		-	-0.6	-	mV/°C
Output Noise Voltage	V _N	f = 10Hz to 100kHz, T _A = +25°C		-	175	-	μV
Ripple Rejection	RR	f = 120Hz, ΔV _I = 10V		54	60	-	dB
Dropout Voltage	V _D	T _J = +25°C, I _O = 1A		-	2	-	V
Short Circuit Current	I _{SC}	T _J = +25°C, V _I = -35V		-	300	-	mA
Peak Current	I _{PK}	T _J = +25°C		-	2.2	-	A

Note

1. Load and line regulation are specified at constant junction temperature. Changes in V_O due to heating effects must be taken into account separately. Pulse testing with low duty is used.

Electrical Characteristics (KA7909) (Continued)(V_I = -15V, I_O = 500mA, 0°C ≤ T_J ≤ +125°C, C_I = 2.2μF, C_O = 1μF, unless otherwise specified.)

Parameter	Symbol	Conditions	Min.	Typ.	Max.	Unit	
Output Voltage	V _O	T _J = +25°C	-8.7	-9.0	-9.3	V	
		I _O = 5mA to 1A, P _O ≤ 15W V _I = -1.5V to -23V	-8.6	-9.0	-9.4		
Line Regulation (Note1)	ΔV _O	T _J = +25°C	V _I = -11.5V to -26V	-	10	180	mV
			V _I = -12V to -18V	-	5	90	
Load Regulation (Note1)	ΔV _O	T _J = +25°C, I _O = 5mA to 1.5A		-	12	180	mV
		T _J = +25°C, I _O = 250mA to 750mA		-	4	90	
Quiescent Current	I _Q	T _J = +25°C	-	3	6	mA	
Quiescent Current Change	ΔI _Q	I _O = 5mA to 1A		-	0.05	0.5	mA
		V _I = -11.5V to -26V		-	0.1	1	
Temperature Coefficient of V _D	ΔV _O /ΔT	I _O = 5mA		-	-0.6	-	mV/°C
Output Noise Voltage	V _N	f = 10Hz to 100kHz, T _A = +25°C		-	175	-	μV
Ripple Rejection	RR	f = 120Hz, ΔV _I = 10V		54	60	-	dB
Dropout Voltage	V _D	T _J = +25°C, I _O = 1A		-	2	-	V
Short Circuit Current	I _{SC}	T _J = +25°C, V _I = -35V		-	300	-	mA
Peak Current	I _{PK}	T _J = +25°C		-	2.2	-	A

Note

1. Load and line regulation are specified at constant junction temperature. Changes in V_O due to heating effects must be taken into account separately. Pulse testing with low duty is used.

Electrical Characteristics (KA7910) (Continued)(V_I = -17V, I_O = 500mA, 0°C ≤ T_J ≤ +125°C, C_I = 2.2μF, C_O = 1μF, unless otherwise specified.)

Parameter	Symbol	Conditions	Min.	Typ.	Max.	Unit	
Output Voltage	V _O	T _J = +25°C	-9.6	-10	-10.4	V	
		I _O = 5mA to 1A, P _O ≤ 15W V _I = -12V to -28	-9.5	-10	-10.5		
Line Regulation (Note1)	ΔV _O	T _J = +25°C	V _I = -12.5V to -28V	-	12	200	mV
			V _I = -14V to -20V	-	6	100	
Load Regulation (Note1)	ΔV _O	T _J = +25°C, I _O = 5mA to 1.5A	-	12	200	mV	
		T _J = +25°C, I _O = 250mA to 750mA	-	4	100		
Quiescent Current	I _Q	T _J = +25°C	-	3	6	mA	
Quiescent Current Change	ΔI _Q	I _O = 5mA to 1A	-	0.05	0.5	mA	
		V _I = -12.5 to -28V	-	0.1	1		
Temperature Coefficient of V _O	ΔV _O /ΔT	I _O = 5mA	-	-1	-	mV/°C	
Output Noise Voltage	V _N	10Hz ≤ f ≤ 100kHz, T _A = +25°C	-	280	-	μV	
Ripple Rejection	RR	f = 120Hz, ΔV _I = 10V	54	60	-	dB	
Dropout Voltage	V _D	T _J = +25°C, I _O = 1A	-	2	-	V	
Short Circuit Current	I _{SC}	T _J = +25°C, V _I = -35V	-	300	-	mA	
Peak Current	I _{PK}	T _J = +25°C	-	2.2	-	A	

Note

1. Load and line regulation are specified at constant junction temperature. Changes in V_O due to heating effects must be taken into account separately. Pulse testing with low duty is used.

Electrical Characteristics (KA7912) (Continued)(V_I = -19V, I_O = 500mA, 0°C ≤ T_J ≤ +125°C, C_I = 2.2μF, C_O = 1μF, unless otherwise specified.)

Parameter	Symbol	Conditions	Min.	Typ.	Max.	Unit	
Output Voltage	V _O	T _J = +25°C	-11.5	-12	-12.5	V	
		I _O = 5mA to 1A, P _O ≤ 15W V _I = -15.5V to -27V	-11.4	-12	-12.6		
Line Regulation (Note1)	ΔV _O	T _J = +25°C	V _I = -14.5V to -30V	-	12	240	mV
			V _I = -16V to -22V	-	6	120	
Load Regulation (Note1)	ΔV _O	T _J = +25°C, I _O = 5mA to 1.5A		-	12	240	mV
		T _J = +25°C, I _O = 250mA to 750mA		-	4	120	
Quiescent Current	I _Q	T _J = +25°C	-	3	6	mA	
Quiescent Current Change	ΔI _Q	I _O = 5mA to 1A		-	0.05	0.5	mA
		V _I = -14.5V to -30V		-	0.1	1	
Temperature Coefficient of V _D	ΔV _O /ΔT	I _O = 5mA		-	-0.8	-	mV/°C
Output Noise Voltage	V _N	f = 10Hz to 100kHz, T _A = +25°C		-	200	-	μV
Ripple Rejection	RR	f = 120Hz, ΔV _I = 10V		54	60	-	dB
Dropout Voltage	V _D	T _J = +25°C, I _O = 1A		-	2	-	V
Short Circuit Current	I _{SC}	T _J = +25°C, V _I = -35V		-	300	-	mA
Peak Current	I _{PK}	T _J = +25°C		-	2.2	-	A

Note

1. Load and line regulation are specified at constant junction temperature. Changes in V_O due to heating effects must be taken into account separately. Pulse testing with low duty is used.

Electrical Characteristics (KA7915) (Continued)(V_I = -23V, I_O = 500mA, 0°C ≤ T_J ≤ +125°C, C_I = 2.2μF, C_O = 1μF, unless otherwise specified.)

Parameter	Symbol	Conditions	Min.	Typ.	Max.	Unit	
Output Voltage	V _O	T _J = +25°C	-14.4	-15	-15.6	V	
		I _O = 5mA to 1A, P _O ≤ 15W V _I = -18V to -30V	-14.25	-15	-15.75		
Line Regulation (Note1)	ΔV _O	T _J = +25°C	V _I = -17.5V to -30V	-	12	300	mV
			V _I = -20V to -26V	-	6	150	
Load Regulation (Note1)	ΔV _O	T _J = +25°C, I _O = 5mA to 1.5A		-	12	300	mV
		T _J = +25°C, I _O = 250mA to 750mA		-	4	150	
Quiescent Current	I _Q	T _J = +25°C	-	3	6	mA	
Quiescent Current Change	ΔI _Q	I _O = 5mA to 1A		-	0.05	0.5	mA
		V _I = -17.5V to -30V		-	0.1	1	
Temperature Coefficient of V _D	ΔV _O /ΔT	I _O = 5mA		-	-0.9	-	mV/°C
Output Noise Voltage	V _N	f = 10Hz to 100kHz, T _A = +25°C		-	250	-	μV
Ripple Rejection	RR	f = 120Hz, ΔV _I = 10V		54	60	-	dB
Dropout Voltage	V _D	T _J = +25°C, I _O = 1A		-	2	-	V
Short Circuit Current	I _{SC}	T _J = +25°C, V _I = -35V		-	300	-	mA
Peak Current	I _{PK}	T _J = +25°C		-	2.2	-	A

Note

1. Load and line regulation are specified at constant junction temperature. Changes in V_O due to heating effects must be taken into account separately. Pulse testing with low duty is used.

Electrical Characteristics (KA7918) (Continued)(V_I = -27V, I_O = 500mA, 0°C ≤ T_J ≤ +125°C, C_I = 2.2μF, C_O = 1μF, unless otherwise specified.)

Parameter	Symbol	Conditions	Min.	Typ.	Max.	Unit	
Output Voltage	V _O	T _J = +25°C	-17.3	-18	-18.7	V	
		I _O = 5mA to 1A, P _O ≤ 15W V _I = -22.5V to -33V	-17.1	-18	-18.9		
Line Regulation (Note1)	ΔV _O	T _J = +25°C	V _I = -21V to -33V	-	15	360	mV
			V _I = -24V to -30V	-	8	180	
Load Regulation (Note1)	ΔV _O	T _J = +25°C, I _O = 5mA to 1.5A	-	15	360	mV	
		T _J = +25°C, I _O = 250mA to 750mA	-	5	180		
Quiescent Current	I _Q	T _J = +25°C	-	3	6	mA	
Quiescent Current Change	ΔI _Q	I _O = 5mA to 1A	-	0.05	0.5	mA	
		V _I = -21V to -33V	-	0.1	1		
Temperature Coefficient of V _D	ΔV _O /ΔT	I _O = 5mA	-	-1	-	mV/°C	
Output Noise Voltage	V _N	f = 10Hz to 100kHz, T _A = +25°C	-	300	-	μV	
Ripple Rejection	RR	f = 120Hz, ΔV _I = 10V	54	60	-	dB	
Dropout Voltage	V _D	T _J = +25°C, I _O = 1A	-	2	-	V	
Short Circuit Current	I _{SC}	T _J = +25°C, V _I = -35V	-	300	-	mA	
Peak Current	I _{PK}	T _J = +25°C	-	2.2	-	A	

Note

1. Load and line regulation are specified at constant junction temperature. Changes in V_O due to heating effects must be taken into account separately. Pulse testing with low duty is used.

Electrical Characteristics (KA7924) (Continued)(V_I = -33V, I_O = 500mA, 0°C ≤ T_J ≤ +125°C, C_I = 2.2μF, C_O = 1μF, unless otherwise specified.)

Parameter	Symbol	Conditions	Min.	Typ.	Max.	Unit	
Output Voltage	V _O	T _J = +25°C	-23	-24	-25	V	
		I _O = 5mA to 1A, P _O ≤ 15W V _I = -27V to -38V	-22.8	-24	-25.2		
Line Regulation (Note1)	ΔV _O	T _J = +25°C	V _I = -27V to -38V	-	15	480	mV
			V _I = -30V to -36V	-	8	180	
Load Regulation (Note1)	ΔV _O	T _J = +25°C, I _O = 5mA to 1.5A		-	15	480	mV
		T _J = +25°C, I _O = 250mA to 750mA		-	5	240	
Quiescent Current	I _Q	T _J = +25°C	-	3	6	mA	
Quiescent Current Change	ΔI _Q	I _O = 5mA to 1A	-	0.05	0.5	mA	
		V _I = -27V to -38V	-	0.1	1		
Temperature Coefficient of V _D	ΔV _O /ΔT	I _O = 5mA	-	-1	-	mV/°C	
Output Noise Voltage	V _N	f = 10Hz to 100kHz, T _A = +25°C	-	400	-	μV	
Ripple Rejection	RR	f = 120Hz, ΔV _I = 10V	54	60	-	dB	
Dropout Voltage	V _D	T _J = +25°C, I _O = 1A	-	2	-	V	
Short Circuit Current	I _{SC}	T _J = +25°C, V _I = -35V	-	300	-	mA	
Peak Current	I _{PK}	T _J = +25°C	-	2.2	-	A	

Note

1. Load and line regulation are specified at constant junction temperature. Changes in V_O due to heating effects must be taken into account separately. Pulse testing with low duty is used.

Electrical Characteristics (KA7905A) (Continued)(V_I = -10V, I_O = 500mA, 0°C ≤ T_J ≤ +125°C, C_I = 2.2μF, C_O = 1μF, unless otherwise specified.)

Parameter	Symbol	Conditions	Min.	Typ.	Max.	Unit	
Output Voltage	V _O	T _J = +25°C	-4.9	-5.0	-5.1	V	
		I _O = 5mA to 1A, P _O ≤ 15W V _I = -7V to -20V	-4.8	-5.0	-5.2		
Line Regulation (Note1)	ΔV _O	T _J = +25°C	V _I = -7V to -20V I _O = 1A	-	5	50	mV
			V _I = -8V to -12V I _O = 1A	-	2	25	
		V _I = -7.5V to -25V	-	7	50		
		V _I = -8V to -12V, I _O = 1A	-	7	50		
Load Regulation (Note1)	ΔV _O	I _O = 5mA to 1.5A T _J = +25°C	-	10	100	mV	
		T _J = +25°C, I _O = 250mA to 750mA	-	3	50		
Quiescent Current	I _Q	T _J = +25°C	-	3	6	mA	
Quiescent Current Change	ΔI _Q	I _O = 5mA to 1A	-	0.05	0.5	mA	
		V _I = -8V to -25V	-	0.1	0.8		
Temperature Coefficient of V _D	ΔV _O /ΔT	I _O = 5mA	-	-0.4	-	mV/°C	
Output Noise Voltage	V _N	f = 10Hz to 100kHz, T _A = +25°C	-	40	-	μV	
Ripple Rejection	RR	f = 120Hz, ΔV _I = 10V	54	60	-	dB	
Dropout Voltage	V _D	T _J = +25°C, I _O = 1A	-	2	-	V	
Short Circuit Current	I _{SC}	T _J = +25°C, V _I = -35V	-	300	-	mA	
Peak Current	I _{PK}	T _J = +25°C	-	2.2	-	A	

Note

1. Load and line regulation are specified at constant junction temperature. Changes in V_O due to heating effects must be taken into account separately. Pulse testing with low duty is used.

Electrical Characteristics (KA7912A) (Continued)(V_I = -19V, I_O = 500mA, 0°C ≤ T_J ≤ +125°C, C_I = 2.2μF, C_O = 1μF, unless otherwise specified.)

Parameter	Symbol	Conditions	Min.	Typ.	Max.	Unit	
Output Voltage	V _O	T _J = +25°C	-11.75	-12	-12.25	V	
		I _O = 5mA to 1A, P _O ≤ 15W V _I = -15.5V to -27V	-11.5	-12	-12.5		
Line Regulation (Note1)	ΔV _O	T _J = +25°C	V _I = -14.5V to -27V I _O = 1A	-	12	120	mV
			V _I = -16V to -22V I _O = 1A	-	6	60	
		V _I = -14.8V to -30V	-	12	120		
		V _I = -16V to -22V, I _O = 1A	-	12	120		
Load Regulation (Note1)	ΔV _O	T _J = +25°C, I _O = 5mA to 1.5A	-	12	150	mV	
		T _J = +25°C, I _O = 250mA to 750mA	-	4	75		
Quiescent Current	I _Q	T _J = +25°C	-	3	6	mA	
Quiescent Current Change	ΔI _Q	I _O = 5mA to 1A	-	0.05	0.5	mA	
		V _I = -15V to -30V	-	0.1	1		
Temperature Coefficient of V _D	ΔV _O /ΔT	I _O = 5mA	-	-0.8	-	mV/°C	
Output Noise Voltage	V _N	f = 10Hz to 100kHz, T _A = +25°C	-	200	-	μV	
Ripple Rejection	RR	f = 120Hz, ΔV _I = 10V	54	60	-	dB	
Dropout Voltage	V _D	T _J = +25°C, I _O = 1A	-	2	-	V	
Short Circuit Current	I _{SC}	T _J = +25°C, V _I = -35V	-	300	-	mA	
Peak Current	I _{PK}	T _J = +25°C	-	2.2	-	A	

Note

1. Load and line regulation are specified at constant junction temperature. Changes in V_O due to heating effects must be taken into account separately. Pulse testing with low duty is used.

Electrical Characteristics (KA7915A) (Continued)(V_I = -23V, I_O = 500mA, 0°C ≤ T_J ≤ +125°C, C_I = 2.2μF, C_O = 1μF, unless otherwise specified.)

Parameter	Symbol	Conditions	Min.	Typ.	Max.	Unit	
Output Voltage	V _O	T _J = +25°C	-14.7	-15	-15.3	V	
		I _O = 5mA to 1A, P _O ≤ 15W V _I = -18V to -30V	-14.4	-15	-15.6		
Line Regulation (Note1)	ΔV _O	T _J = +25°C	V _I = -17.5V to -30V I _o = 1A	-	12	150	mV
			V _I = -20V to -26V I _o = 1A	-	6	75	
		V _I = -17.9V to -30V	-	12	150		
		V _I = -20V to -26V, I _o = 1A	-	6	150		
Load Regulation (Note1)	ΔV _O	T _J = +25°C, I _O = 5mA to 1.5A	-	12	150	mV	
		T _J = +25°C, I _O = 250mA to 750mA	-	4	75		
Quiescent Current	I _Q	T _J = +25°C	-	3	6	mA	
Quiescent Current Change	ΔI _Q	I _O = 5mA to 1A	-	0.05	0.5	mA	
		V _I = -18.5V to -30V	-	0.1	1		
Temperature Coefficient of V _D	ΔV _O /ΔT	I _O = 5mA	-	-0.9	-	mV/°C	
Output Noise Voltage	V _N	f = 10Hz to 100kHz, T _A = +25°C	-	250	-	μV	
Ripple Rejection	RR	f = 120Hz, ΔV _I = 10V	54	60	-	dB	
Dropout Voltage	V _D	T _J = +25°C, I _O = 1A	-	2	-	V	
Short Circuit Current	I _{SC}	T _J = +25°C, V _I = -35V	-	300	-	mA	
Peak Current	I _{PK}	T _J = +25°C	-	2.2	-	A	

Note

1. Load and line regulation are specified at constant junction temperature. Changes in V_O due to heating effects must be taken into account separately. Pulse testing with low duty is used.

Typical Performance Characteristics

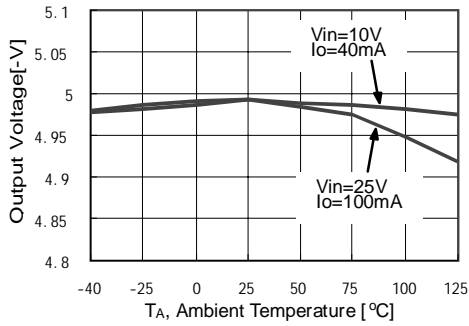

Figure 1. Output Voltage

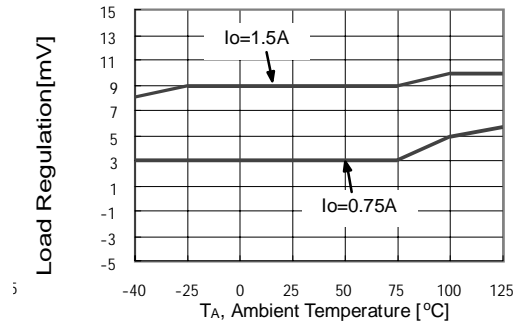

Figure 2. Load Regulation

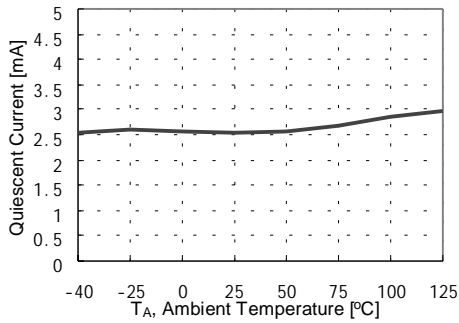

Figure 3. Quiescent Current

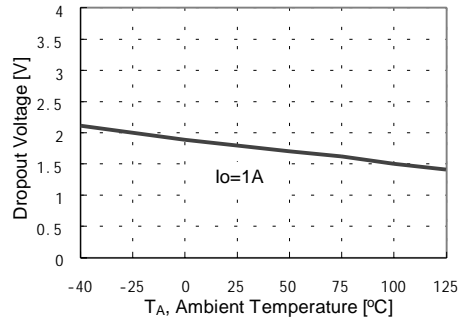

Figure 4. Dropout Voltage

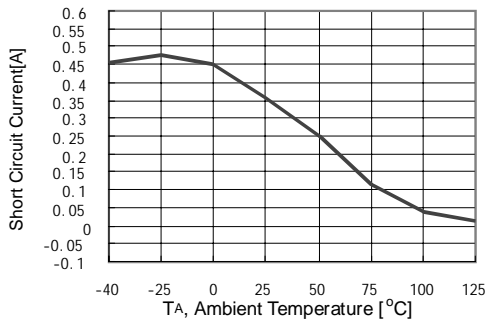

Figure 5. Short Circuit Current

Typical Applications

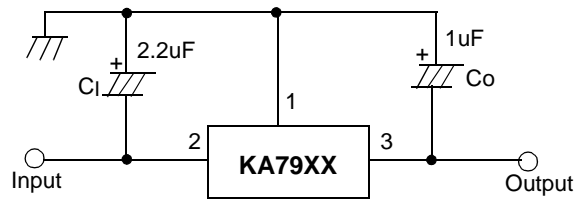

Figure 6. Negative Fixed output regulator

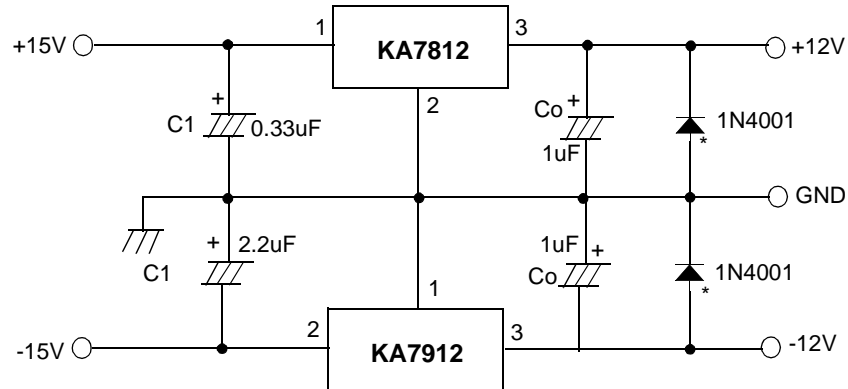

Figure 7. Split power supply (± 12V/1A)

Note:

- (1) To specify an output voltage, substitute voltage value for "XX "
- (2) Required for stability. For value given, capacitor must be solid tantalum. If aluminium electronics are used, at least ten times value shown should be selected. C₁ is required if regulator is located an appreciable distance from power supply filter.
- (3) To improve transient response. If large capacitors are used, a high current diode from input to output (1N4001 or similar) should be introduced to protect the device from momentary input short circuit.

Ordering Information

Product Number	Output Voltage Tolerance	Package	Operating Temperature
KA7905	±4%	TO-220	0 ~ +125°C
KA7906			
KA7908			
KA7909			
KA7910			
KA7912			
KA7915			
KA7918			
KA7924			
KA7905A			
KA7912A			
KA7915A			

DISCLAIMER

FAIRCHILD SEMICONDUCTOR RESERVES THE RIGHT TO MAKE CHANGES WITHOUT FURTHER NOTICE TO ANY PRODUCTS HEREIN TO IMPROVE RELIABILITY, FUNCTION OR DESIGN. FAIRCHILD DOES NOT ASSUME ANY LIABILITY ARISING OUT OF THE APPLICATION OR USE OF ANY PRODUCT OR CIRCUIT DESCRIBED HEREIN; NEITHER DOES IT CONVEY ANY LICENSE UNDER ITS PATENT RIGHTS, NOR THE RIGHTS OF OTHERS.

LIFE SUPPORT POLICY

FAIRCHILD'S PRODUCTS ARE NOT AUTHORIZED FOR USE AS CRITICAL COMPONENTS IN LIFE SUPPORT DEVICES OR SYSTEMS WITHOUT THE EXPRESS WRITTEN APPROVAL OF THE PRESIDENT OF FAIRCHILD SEMICONDUCTOR CORPORATION. As used herein:

1. Life support devices or systems are devices or systems which, (a) are intended for surgical implant into the body, or (b) support or sustain life, and (c) whose failure to perform when properly used in accordance with instructions for use provided in the labeling, can be reasonably expected to result in a significant injury of the user.
2. A critical component in any component of a life support device or system whose failure to perform can be reasonably expected to cause the failure of the life support device or system, or to affect its safety or effectiveness.