

LME49860

44V Dual High Performance, High Fidelity Audio Operational Amplifier

General Description

The LME49860 is part of the ultra-low distortion, low noise, high slew rate operational amplifier series optimized and fully specified for high performance, high fidelity applications. Combining advanced leading-edge process technology with state-of-the-art circuit design, the LME49860 audio operational amplifiers deliver superior audio signal amplification for outstanding audio performance. The LME49860 combines extremely low voltage noise density ($2.7\text{nV}/\sqrt{\text{Hz}}$) with vanishingly low THD+N (0.00003%) to easily satisfy the most demanding audio applications. To ensure that the most challenging loads are driven without compromise, the LME49860 has a high slew rate of $\pm 20\text{V}/\mu\text{s}$ and an output current capability of $\pm 26\text{mA}$. Further, dynamic range is maximized by an output stage that drives $2\text{k}\Omega$ loads to within 1V of either power supply voltage and to within 1.4V when driving 600Ω loads.

The LME49860's outstanding CMRR (120dB), PSRR (120dB), and V_{OS} (0.1mV) give the amplifier excellent operational amplifier DC performance.

The LME49860 has a wide supply range of $\pm 2.5\text{V}$ to $\pm 22\text{V}$. Over this supply range the LME49860 maintains excellent common-mode rejection, power supply rejection, and low input bias current. The LME49860 is unity gain stable. This Audio Operational Amplifier achieves outstanding AC performance while driving complex loads with values as high as 100pF.

The LME49860 is available in 8-lead narrow body SOIC and 8-lead Plastic DIP packages. Demonstration boards are available for each package.

Key Specifications

- Power Supply Voltage Range $\pm 2.5\text{V}$ to $\pm 22\text{V}$
- THD+N
($A_V = 1$, $V_{\text{OUT}} = 3V_{\text{RMS}}$, $f_{\text{IN}} = 1\text{kHz}$)

$R_L = 2\text{k}\Omega$	0.00003% (typ)
$R_L = 600\Omega$	0.00003% (typ)
■ Input Noise Density	$2.7\text{nV}/\sqrt{\text{Hz}}$ (typ)
■ Slew Rate	$\pm 20\text{V}/\mu\text{s}$ (typ)
■ Gain Bandwidth Product	55MHz (typ)
■ Open Loop Gain ($R_L = 600\Omega$)	140dB (typ)
■ Input Bias Current	10nA (typ)
■ Input Offset Voltage	0.1mV (typ)
■ DC Gain Linearity Error	0.000009%

Features

- Easily drives 600Ω loads
- Optimized for superior audio signal fidelity
- Output short circuit protection
- PSRR and CMRR exceed 120dB (typ)
- SOIC, DIP packages

Applications

- Ultra high quality audio amplification
- High fidelity preamplifiers
- High fidelity multimedia
- State of the art phono pre amps
- High performance professional audio
- High fidelity equalization and crossover networks
- High performance line drivers
- High performance line receivers
- High fidelity active filters

Typical Application

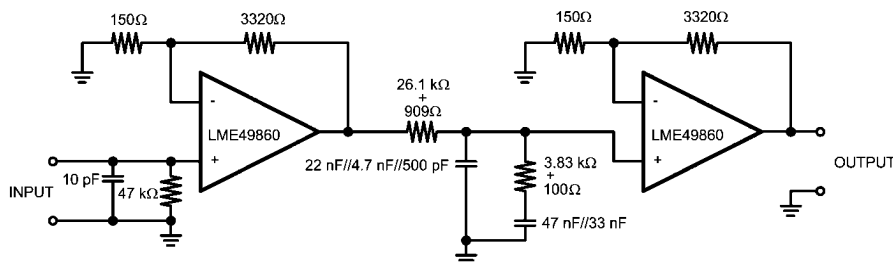

Note: 1% metal film resistors, 5% polypropylene capacitors

Passively Equalized RIAA Phono Preamplifier

202151k5

Connection Diagrams

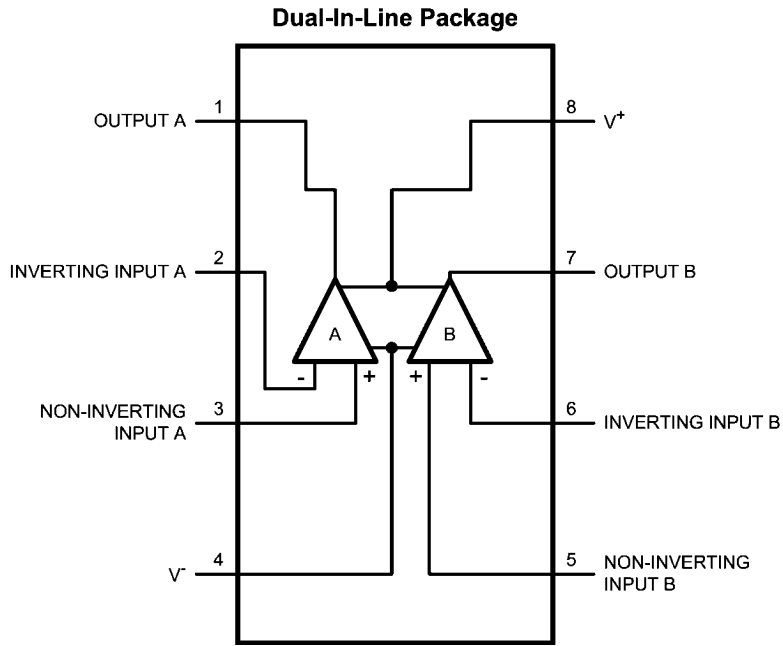

20215155

Order Number LME49860MA
 See NS Package Number — M08A
 Order Number LME49860NA
 See NS Package Number — N08E

LME49860MA Top Mark



20215101

N — National Logo
 Z — Assembly Plant code
 X — 1 Digit Date code
 TT — Die Traceability
 L49860 — LME49860
 MA — Package code

LME49860NA Top Mark

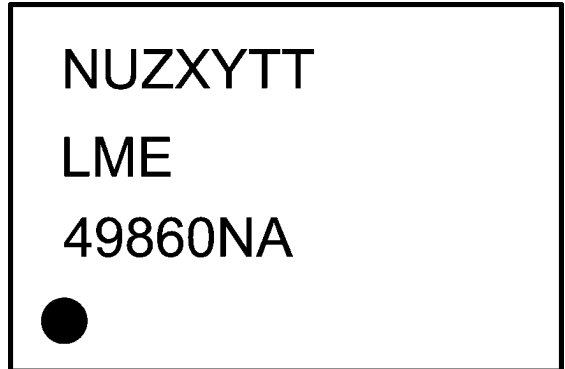

20215102

N — National Logo
 U — Fabrication code
 Z — Assembly Plant code
 XY — 2 Digit Date code
 TT — Die Traceability
 NA — Package code

Absolute Maximum Ratings (Notes 1, 2)

If Military/Aerospace specified devices are required, please contact the National Semiconductor Sales Office/ Distributors for availability and specifications.

Power Supply Voltage ($V_S = V^+ - V^-$)	46V
Storage Temperature	-65°C to 150°C
Input Voltage	(V-) - 0.7V to (V+) + 0.7V
Output Short Circuit (Note 3)	Continuous
ESD Susceptibility (Note 4)	2000V
ESD Susceptibility (Note 5)	200V
Pins 1, 4, 7 and 8	200V

Pins 2, 3, 5 and 6	100V
Junction Temperature	150°C
Thermal Resistance	
θ_{JA} (SO)	145°C/W
θ_{JA} (NA)	102°C/W

Operating Ratings

Temperature Range	$T_{MIN} \leq T_A \leq T_{MAX}$	-40°C ≤ T_A ≤ 85°C
Supply Voltage Range		±2.5V ≤ V_S ≤ ±22V

Electrical Characteristics for the LME49860 (Note 1) The following specifications apply for $V_S = \pm 18V$ and $\pm 22V$, $R_L = 2k\Omega$, $R_{SOURCE} = 10\Omega$, $f_{IN} = 1kHz$, $T_A = 25^\circ C$, unless otherwise specified.

Symbol	Parameter	Conditions	LME49860		Units (Limits)
			Typical	Limit	
			(Note 6)	(Note 7)	
THD+N	Total Harmonic Distortion + Noise	$A_V = 1$, $V_{OUT} = 3V_{rms}$ $R_L = 2k\Omega$ $R_L = 600\Omega$	0.00003 0.00003	0.00009	% (max)
IMD	Intermodulation Distortion	$A_V = 1$, $V_{OUT} = 3V_{RMS}$ Two-tone, 60Hz & 7kHz 4:1	0.00005		%
GBWP	Gain Bandwidth Product		55	45	MHz (min)
SR	Slew Rate		±20	±15	V/μs (min)
FPBW	Full Power Bandwidth	$V_{OUT} = 1V_{P-P}$, -3dB referenced to output magnitude at $f = 1kHz$	10		MHz
t_s	Settling time	$A_V = -1$, 10V step, $C_L = 100pF$ 0.1% error range	1.2		μs
e_n	Equivalent Input Noise Voltage	$f_{BW} = 20Hz$ to 20kHz	0.34	0.65	μV _{RMS} (max)
	Equivalent Input Noise Density	$f = 1kHz$ $f = 10Hz$	2.7 6.4	4.7	nV/√Hz (max)
i_n	Current Noise Density	$f = 1kHz$	1.6		pA/√Hz
		$f = 10Hz$	3.1		
V_{OS}	Offset Voltage	$V_S = \pm 18V$	±0.12	±0.7	mV (max)
		$V_S = \pm 22V$	±0.14	±0.7	mV (max)
$\Delta V_{OS}/\Delta Temp$	Average Input Offset Voltage Drift vs Temperature	-40°C ≤ T_A ≤ 85°C	0.2		μV/°C
PSRR	Average Input Offset Voltage Shift vs Power Supply Voltage	(Note 8) $V_S = \pm 18V$, $\Delta V_S = 24V$	120		dB
		$V_S = \pm 22V$, $\Delta V_S = 30V$	120	110	dB (min)
ISO _{CH-CH}	Channel-to-Channel Isolation	$f_{IN} = 1kHz$	118		dB
		$f_{IN} = 20kHz$	112		
I_B	Input Bias Current	$V_{CM} = 0V$	10	72	nA (max)
$\Delta I_{OS}/\Delta Temp$	Input Bias Current Drift vs Temperature	-40°C ≤ T_A ≤ 85°C	0.1		nA/°C
I_{OS}	Input Offset Current	$V_{CM} = 0V$	11	65	nA (max)
V_{IN-CM}	Common-Mode Input Voltage Range	$V_S = \pm 18V$	+17.1 -16.9	(V+) - 2.0 (V-) + 2.0	V (min) V (min)
		$V_S = \pm 22V$	+21.0	(V+) - 2.0	V (min)
			-20.8	(V-) + 2.0	V (min)

Symbol	Parameter	Conditions	LME49860		Units (Limits)
			Typical	Limit	
			(Note 6)	(Note 7)	
CMRR	Common-Mode Rejection	$V_S = \pm 18V$ $-12V \leq V_{CM} \leq 12V$	120		dB
		$V_S = \pm 22V$ $-15V \leq V_{CM} \leq 15V$	120	110	dB (min)
Z_{IN}	Differential Input Impedance		30		k Ω
	Common Mode Input Impedance	$-10V < V_{cm} < 10V$	1000		M Ω
A_{VOL}	Open Loop Voltage Gain	$V_S = \pm 18V$ $-12V \leq V_{out} \leq 12V$ $R_L = 600\Omega$ $R_L = 2k\Omega$ $R_L = 10k\Omega$	140 140 140		dB dB dB
		$V_S = \pm 22V$ $-15V \leq V_{out} \leq 15V$ $R_L = 600\Omega$ $R_L = 2k\Omega$ $R_L = 10k\Omega$	140 140 140	125	dB (min) dB dB
		$R_L = 600\Omega$ $V_S = \pm 18V$ $V_S = \pm 22V$	± 16.7 ± 20.4	± 19.0	V V (min)
		$R_L = 2k\Omega$ $V_S = \pm 18V$ $V_S = \pm 22V$	± 17.0 ± 21.0		V V
V_{OUTMAX}	Maximum Output Voltage Swing	$R_L = 10k\Omega$ $V_S = \pm 18V$ $V_S = \pm 22V$	± 17.1 ± 21.2		V V
		$R_L = 600\Omega$ $V_S = \pm 20V$ $V_S = \pm 22V$	± 31 ± 37	± 30	mA mA (min)
		Instantaneous Short Circuit Current	+53 -42		mA
R_{OUT}	Output Impedance	$f_{IN} = 10kHz$ Closed-Loop Open-Loop	0.01 13		Ω
C_{LOAD}	Capacitive Load Drive Overshoot	100pF	16		%
I_S	Total Quiescent Current	$I_{OUT} = 0mA$ $V_S = \pm 18V$ $V_S = \pm 22V$	10.2 10.5	13	mA mA (max)

Note 1: Absolute Maximum Ratings indicate limits beyond which damage to the device may occur.

Note 2: Operating Ratings indicate conditions for which the device is functional, but do not guarantee specific performance limits. For guaranteed specifications and test conditions, see the Electrical Characteristics. The guaranteed specifications apply only for the test conditions listed. Some performance characteristics may degrade when the device is not operated under the listed test conditions.

Note 3: Amplifier output connected to GND, any number of amplifiers within a package.

Note 4: Human body model, 100pF discharged through a 1.5k Ω resistor.

Note 5: Machine Model ESD test is covered by specification EIAJ IC-121-1981. A 200pF cap is charged to the specified voltage and then discharged directly into the IC with no external series resistor (resistance of discharge path must be under 50 Ω).

Note 6: Typical specifications are specified at +25 $^{\circ}C$ and represent the most likely parametric norm.

Note 7: Tested limits are guaranteed to National's AOQL (Average Outgoing Quality Level).

Note 8: PSRR is measured as follows: For $V_S = \pm 22V$, V_{OS} is measured at two supply voltages, $\pm 7V$ and $\pm 22V$. $PSRR = |20\log(\Delta V_{OS}/\Delta V_S)|$.

Typical Performance Characteristics

THD+N vs Output Voltage
 $V_{CC} = 15V, V_{EE} = -15V$
 $R_L = 2k\Omega$

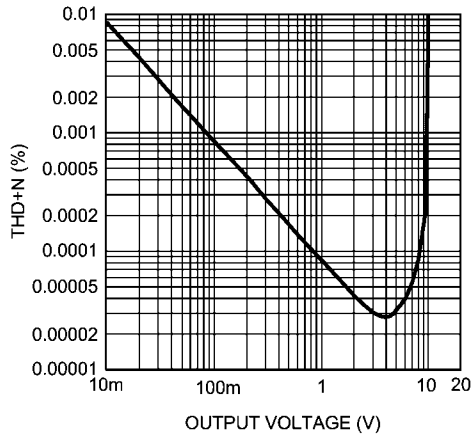

202151k6

THD+N vs Output Voltage
 $V_{CC} = 12V, V_{EE} = -12V$
 $R_L = 2k\Omega$

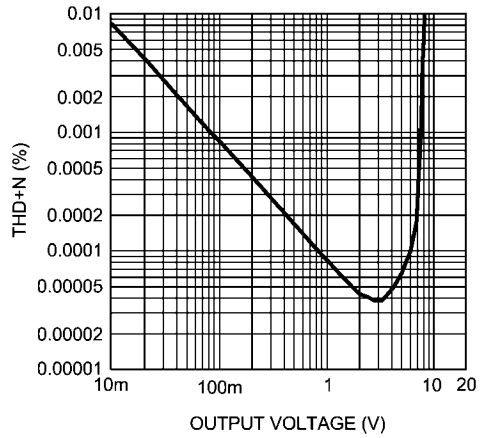

202151k7

THD+N vs Output Voltage
 $V_{CC} = 22V, V_{EE} = -22V$
 $R_L = 2k\Omega$

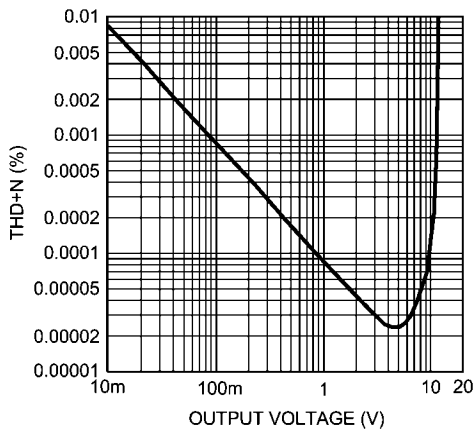

202151k8

THD+N vs Output Voltage
 $V_{CC} = 2.5V, V_{EE} = -2.5V$
 $R_L = 2k\Omega$

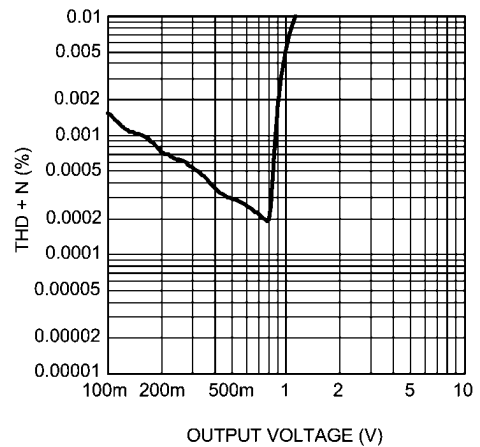

202151i4

THD+N vs Output Voltage
 $V_{CC} = 15V, V_{EE} = -15V$
 $R_L = 600\Omega$

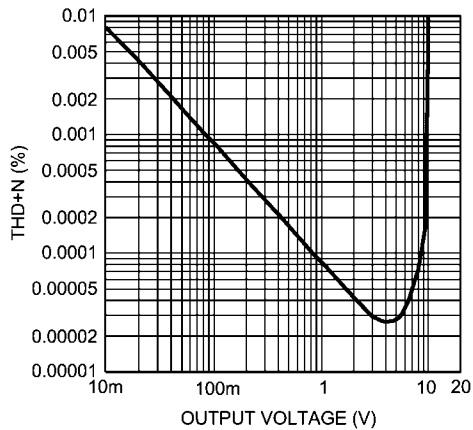

202151k9

THD+N vs Output Voltage
 $V_{CC} = 12V, V_{EE} = -12V$
 $R_L = 600\Omega$

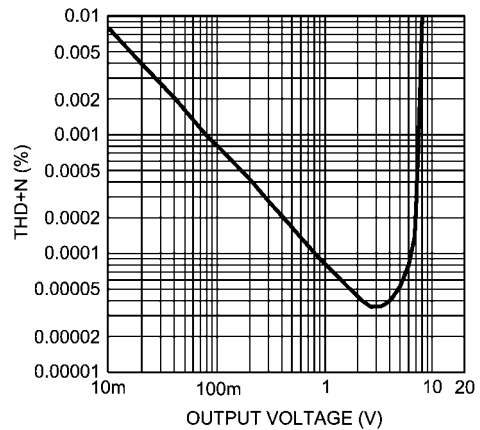

202151i0

THD+N vs Output Voltage
 $V_{CC} = 22V, V_{EE} = -22V$
 $R_L = 600\Omega$

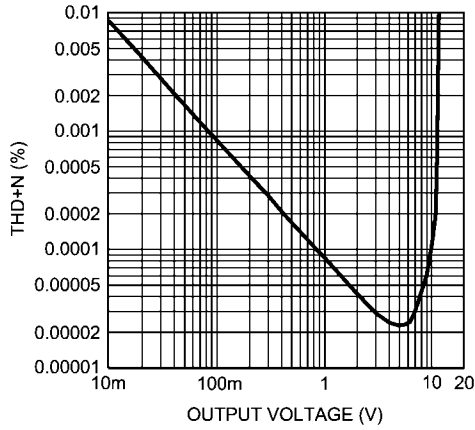

20215111

THD+N vs Output Voltage
 $V_{CC} = 2.5V, V_{EE} = -2.5V$
 $R_L = 600\Omega$

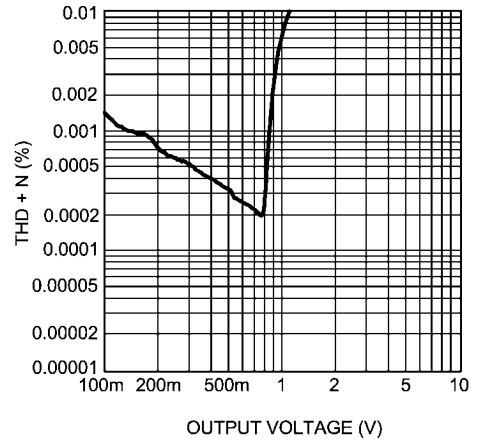

20215116

THD+N vs Output Voltage
 $V_{CC} = 15V, V_{EE} = -15V$
 $R_L = 10k\Omega$

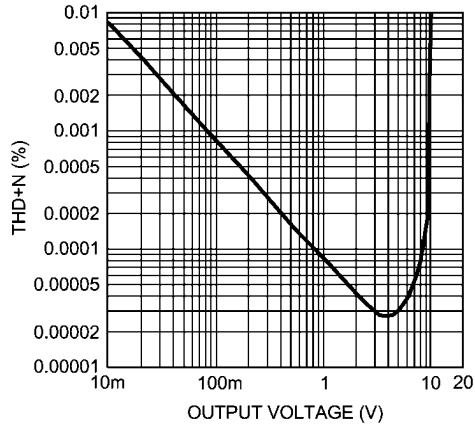

20215112

THD+N vs Output Voltage
 $V_{CC} = 12V, V_{EE} = -12V$
 $R_L = 10k\Omega$

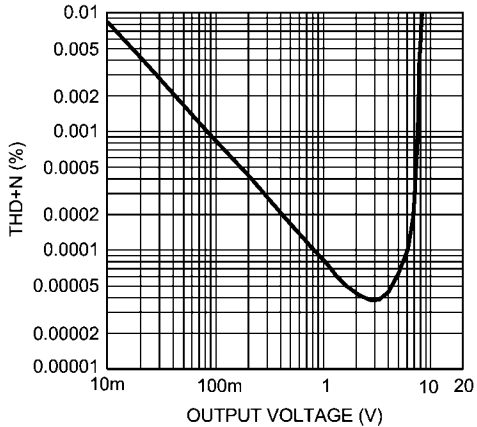

20215113

THD+N vs Output Voltage
 $V_{CC} = 22V, V_{EE} = -22V$
 $R_L = 10k\Omega$

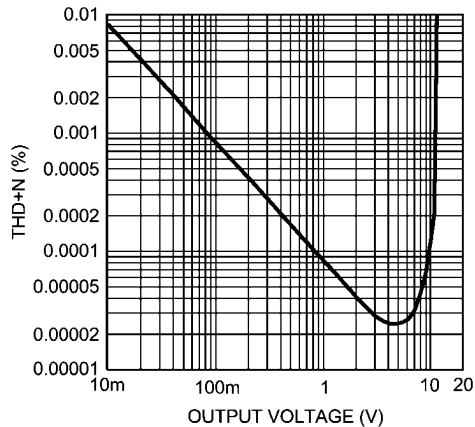

20215114

THD+N vs Output Voltage
 $V_{CC} = 2.5V, V_{EE} = -2.5V$
 $R_L = 10k\Omega$

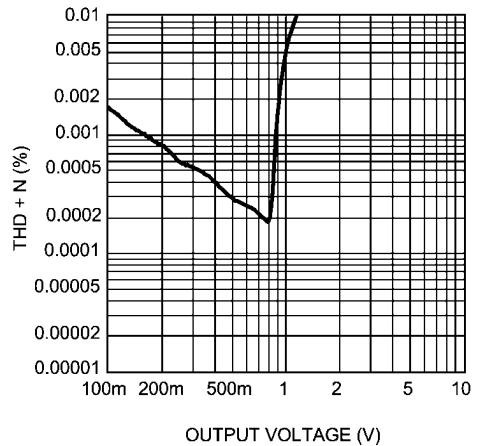

20215115

THD+N vs Frequency
 $V_{CC} = 15V, V_{EE} = -15V, V_{OUT} = 3V_{RMS}$
 $R_L = 2k\Omega$

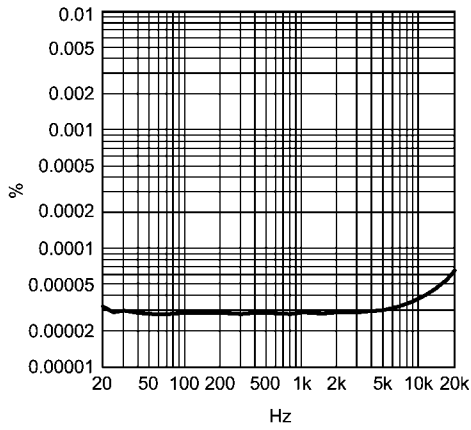

20215163

THD+N vs Frequency
 $V_{CC} = 12V, V_{EE} = -12V, V_{OUT} = 3V_{RMS}$
 $R_L = 2k\Omega$

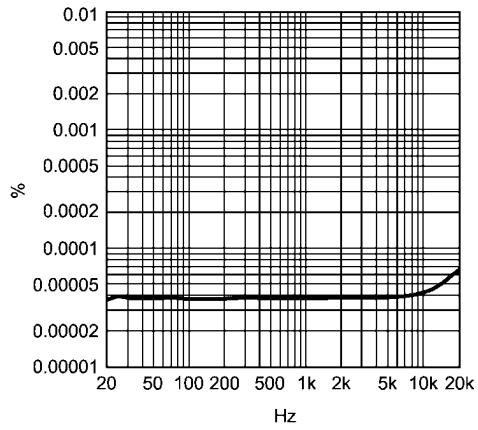

20215162

THD+N vs Frequency
 $V_{CC} = 22V, V_{EE} = -22V, V_{OUT} = 3V_{RMS}$
 $R_L = 2k\Omega$

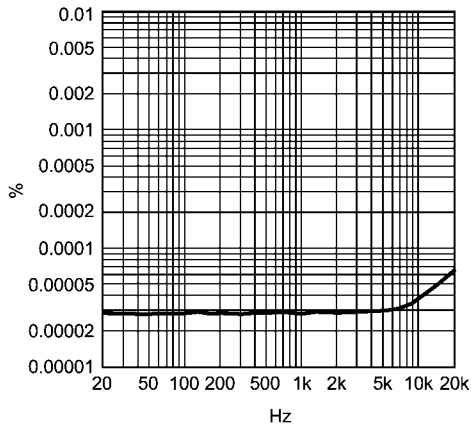

20215164

THD+N vs Frequency
 $V_{CC} = 15V, V_{EE} = -15V, V_{OUT} = 3V_{RMS}$
 $R_L = 600\Omega$

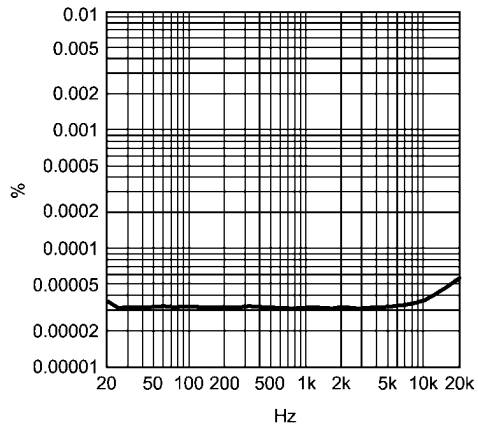

20215159

THD+N vs Frequency
 $V_{CC} = 12V, V_{EE} = -12V, V_{OUT} = 3V_{RMS}$
 $R_L = 600\Omega$

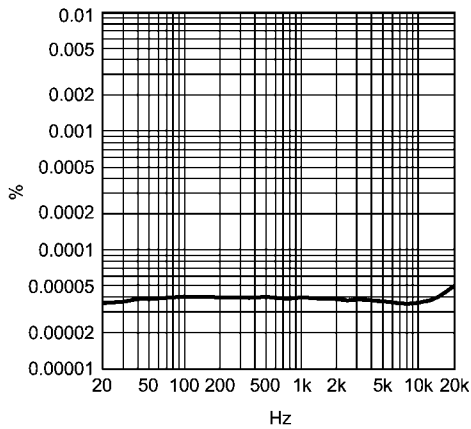

202151k3

THD+N vs Frequency
 $V_{CC} = 22V, V_{EE} = -22V, V_{OUT} = 3V_{RMS}$
 $R_L = 600\Omega$

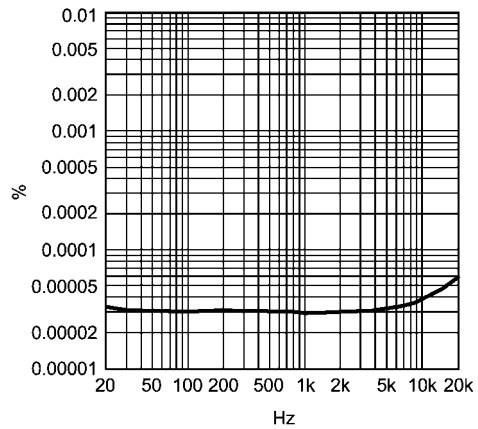

20215160

THD+N vs Frequency
 $V_{CC} = 15V, V_{EE} = -15V, V_{OUT} = 3V_{RMS}$
 $R_L = 10k\Omega$

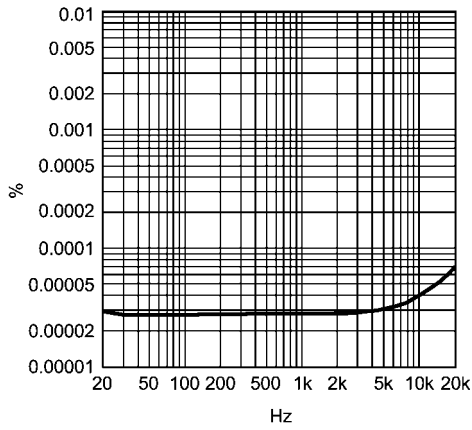

20215167

THD+N vs Frequency
 $V_{CC} = 12V, V_{EE} = -12V, V_{OUT} = 3V_{RMS}$
 $R_L = 10k\Omega$

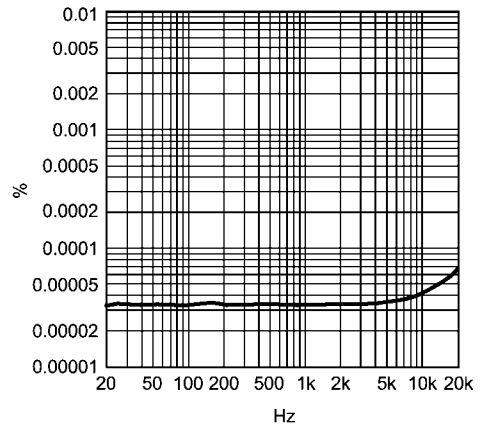

20215166

THD+N vs Frequency
 $V_{CC} = 22V, V_{EE} = -22V, V_{OUT} = 3V_{RMS}$
 $R_L = 10k\Omega$

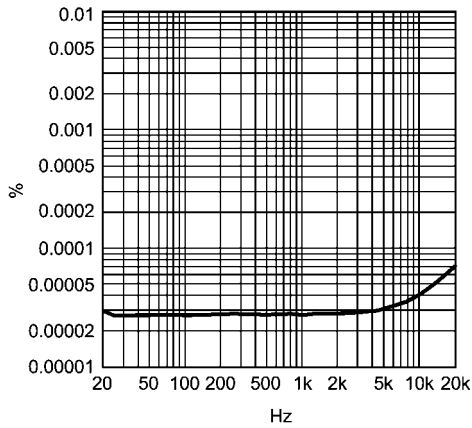

20215168

IMD vs Output Voltage
 $V_{CC} = 15V, V_{EE} = -15V$
 $R_L = 2k\Omega$

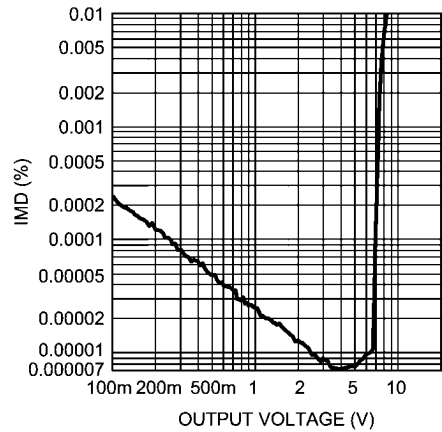

202151e6

IMD vs Output Voltage
 $V_{CC} = 12V, V_{EE} = -12V$
 $R_L = 2k\Omega$

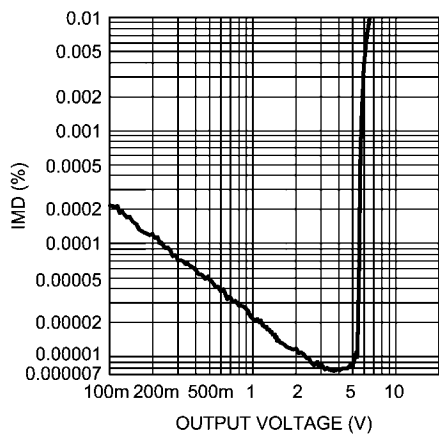

202151e5

IMD vs Output Voltage
 $V_{CC} = 22V, V_{EE} = -22V$
 $R_L = 2k\Omega$

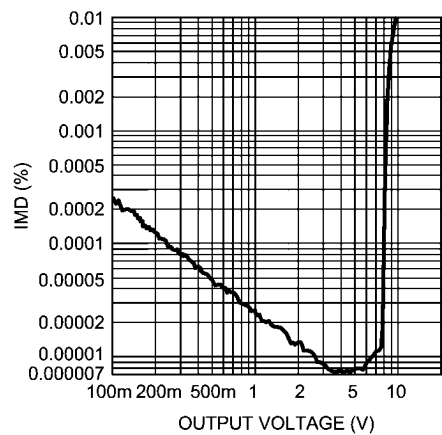

202151e7

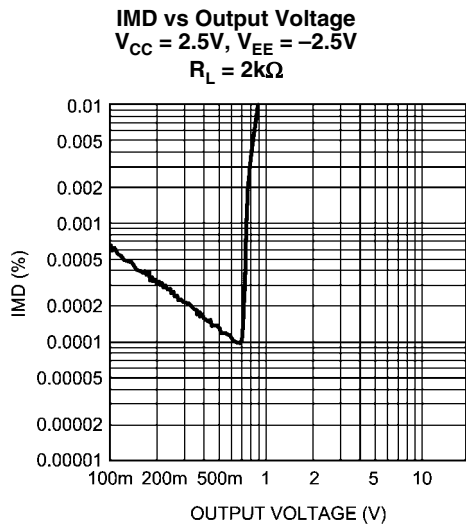

202151e4

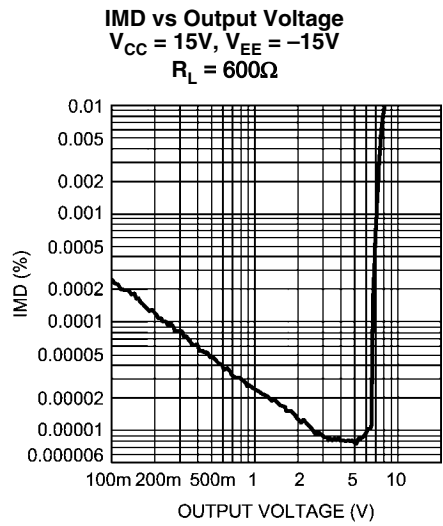

202151e2

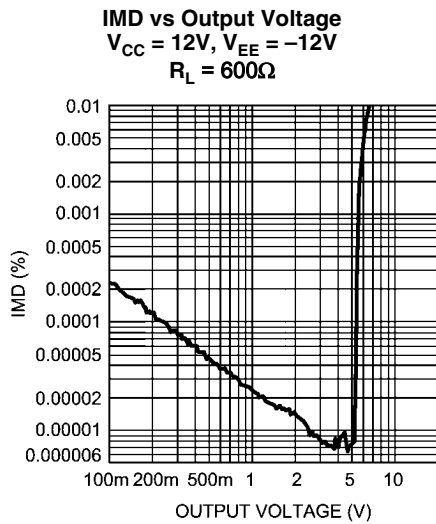

202151e0

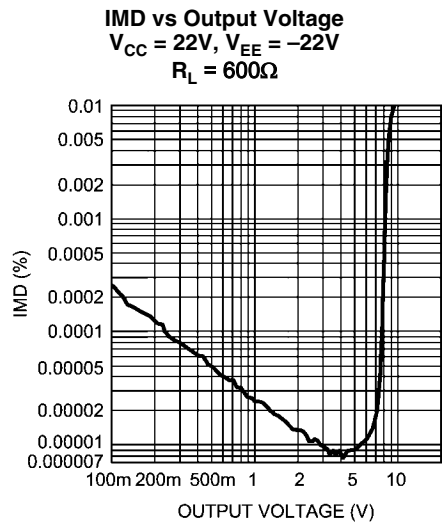

202151e3

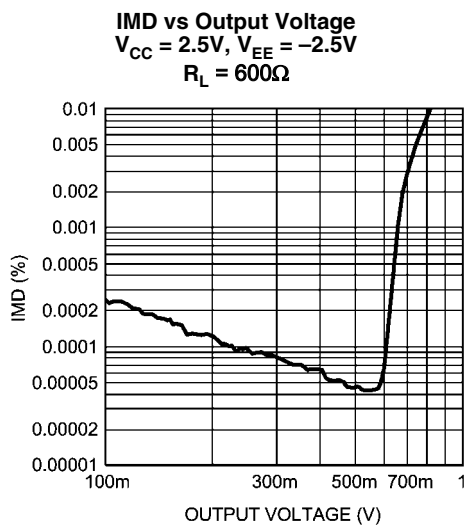

202151e1

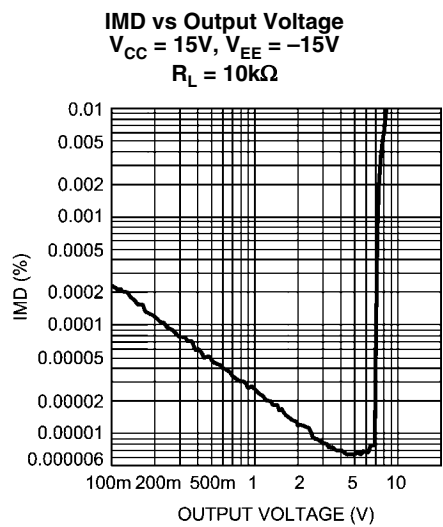

20215111

IMD vs Output Voltage
 $V_{CC} = 12V, V_{EE} = -12V$
 $R_L = 10k\Omega$

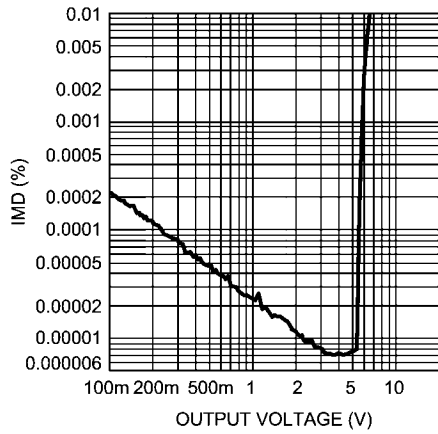

202151f0

IMD vs Output Voltage
 $V_{CC} = 22V, V_{EE} = -22V$
 $R_L = 10k\Omega$

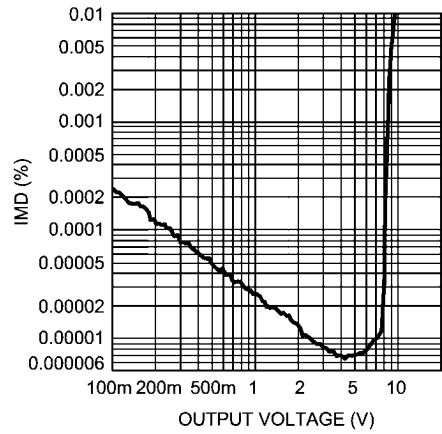

202151f2

IMD vs Output Voltage
 $V_{CC} = 2.5V, V_{EE} = -2.5V$
 $R_L = 10k\Omega$

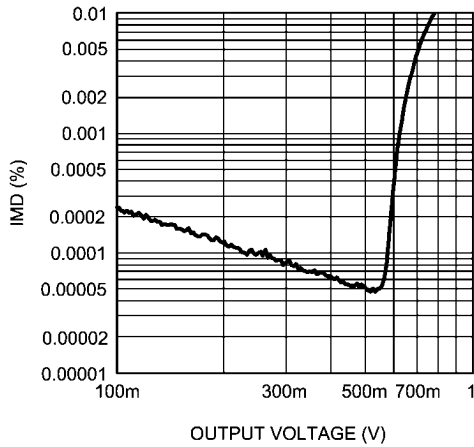

202151h6

Voltage Noise Density vs Frequency

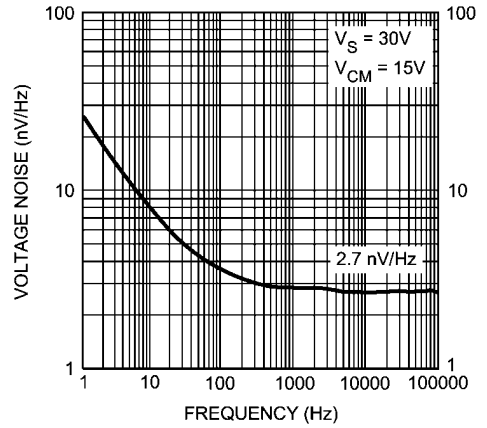

202151h6

Current Noise Density vs Frequency

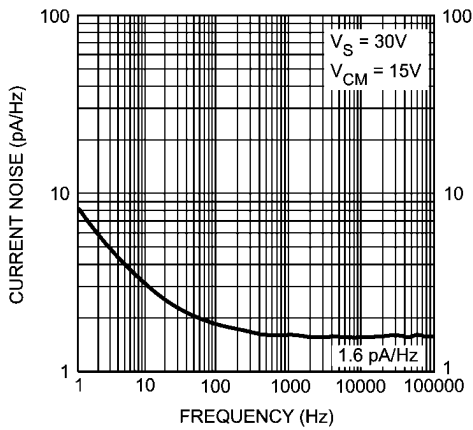

202151h7

Crosstalk vs Frequency
 $V_{CC} = 15V, V_{EE} = -15V, V_{OUT} = 3V_{RMS}$
 $A_V = 0dB, R_L = 2k\Omega$

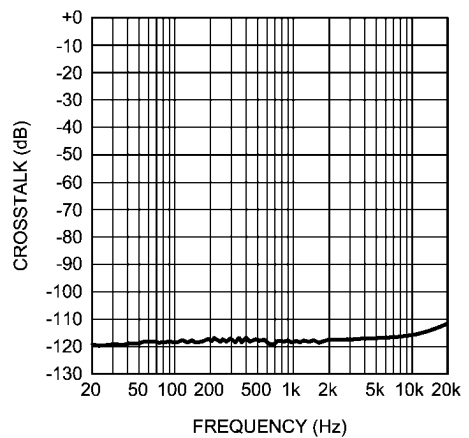

202151c8

Crosstalk vs Frequency
 $V_{CC} = 15V, V_{EE} = -15V, V_{OUT} = 10V_{RMS}$
 $A_V = 0dB, R_L = 2k\Omega$

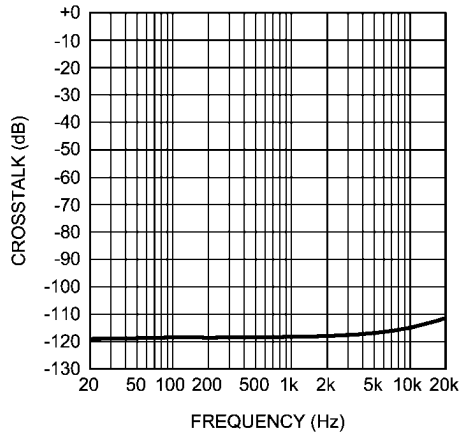

202151c9

Crosstalk vs Frequency
 $V_{CC} = 12V, V_{EE} = -12V, V_{OUT} = 3V_{RMS}$
 $A_V = 0dB, R_L = 2k\Omega$

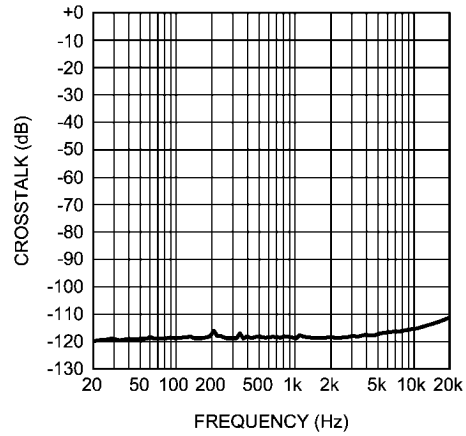

202151c6

Crosstalk vs Frequency
 $V_{CC} = 12V, V_{EE} = -12V, V_{OUT} = 10V_{RMS}$
 $A_V = 0dB, R_L = 2k\Omega$

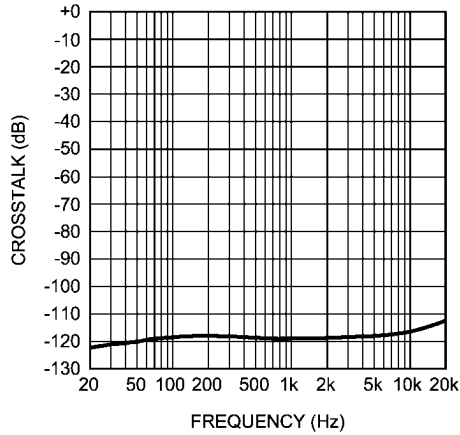

202151c7

Crosstalk vs Frequency
 $V_{CC} = 22V, V_{EE} = -22V, V_{OUT} = 3V_{RMS}$
 $A_V = 0dB, R_L = 2k\Omega$

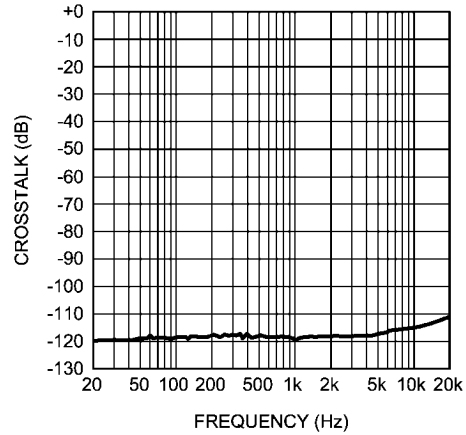

202151d0

Crosstalk vs Frequency
 $V_{CC} = 22V, V_{EE} = -22V, V_{OUT} = 10V_{RMS}$
 $A_V = 0dB, R_L = 2k\Omega$

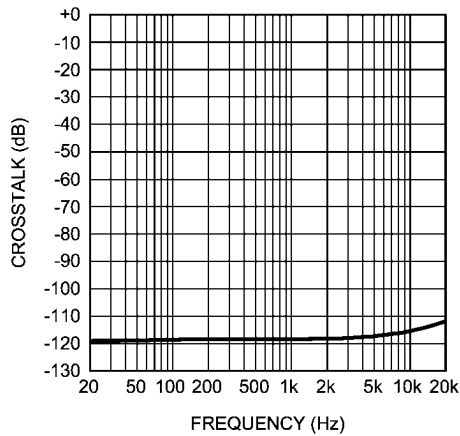

202151d1

Crosstalk vs Frequency
 $V_{CC} = 2.5V, V_{EE} = -2.5V, V_{OUT} = 1V_{RMS}$
 $A_V = 0dB, R_L = 2k\Omega$

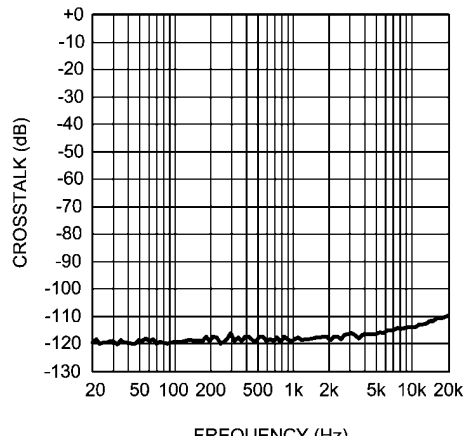

202151n8

Crosstalk vs Frequency
 $V_{CC} = 15V, V_{EE} = -15V, V_{OUT} = 3V_{RMS}$
 $A_V = 0dB, R_L = 600\Omega$

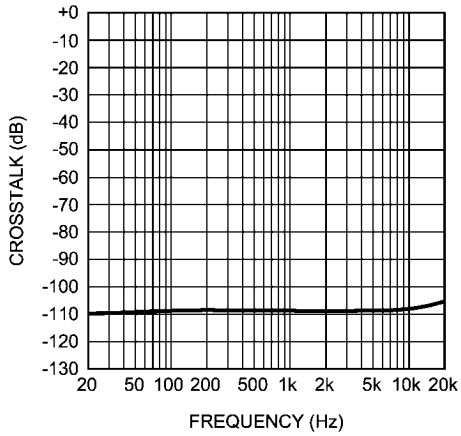

202151d6

Crosstalk vs Frequency
 $V_{CC} = 15V, V_{EE} = -15V, V_{OUT} = 10V_{RMS}$
 $A_V = 0dB, R_L = 600\Omega$

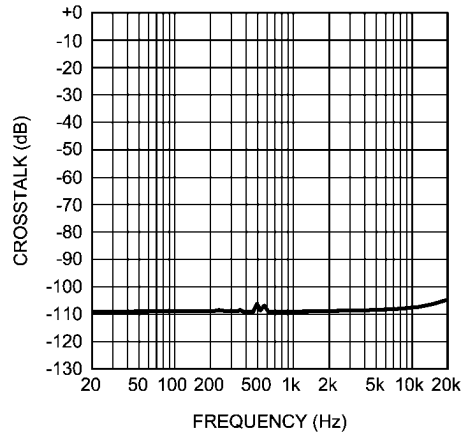

202151d7

Crosstalk vs Frequency
 $V_{CC} = 12V, V_{EE} = -12V, V_{OUT} = 3V_{RMS}$
 $A_V = 0dB, R_L = 600\Omega$

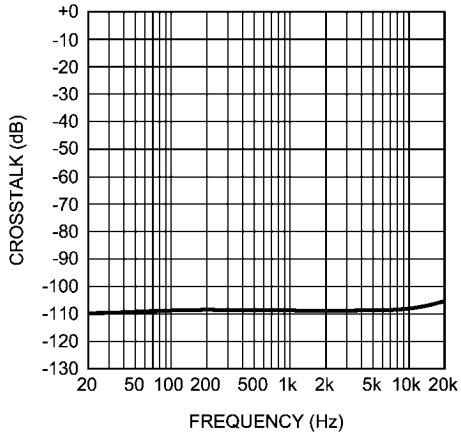

202151d4

Crosstalk vs Frequency
 $V_{CC} = 12V, V_{EE} = -12V, V_{OUT} = 10V_{RMS}$
 $A_V = 0dB, R_L = 600\Omega$

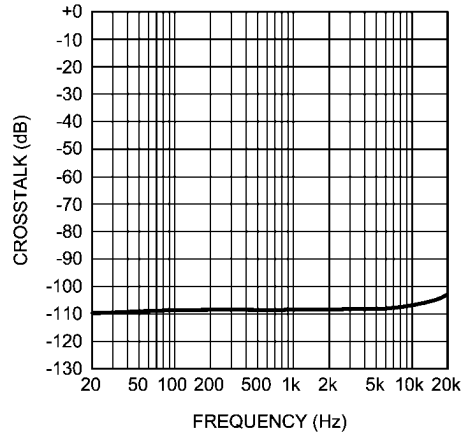

202151d5

Crosstalk vs Frequency
 $V_{CC} = 22V, V_{EE} = -22V, V_{OUT} = 3V_{RMS}$
 $A_V = 0dB, R_L = 600\Omega$

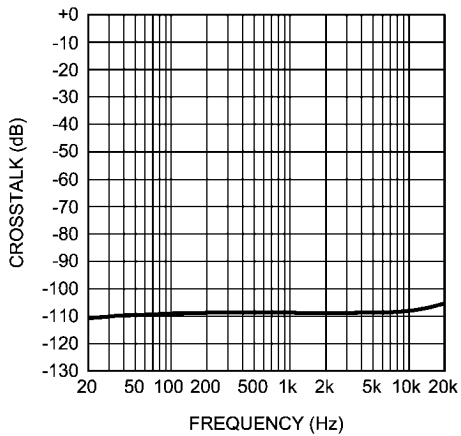

202151d8

Crosstalk vs Frequency
 $V_{CC} = 22V, V_{EE} = -22V, V_{OUT} = 10V_{RMS}$
 $A_V = 0dB, R_L = 600\Omega$

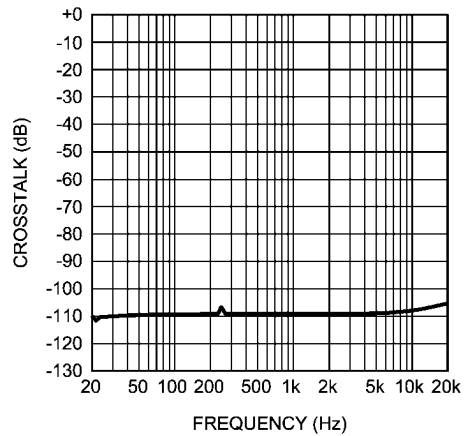

202151d9

Crosstalk vs Frequency
 $V_{CC} = 2.5V, V_{EE} = -2.5V, V_{OUT} = 1V_{RMS}$
 $A_V = 0dB, R_L = 600\Omega$

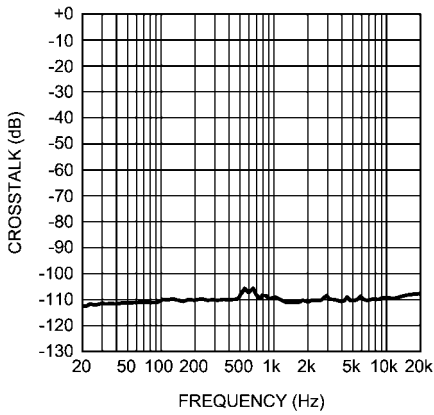

202151d2

Crosstalk vs Frequency
 $V_{CC} = 15V, V_{EE} = -15V, V_{OUT} = 3V_{RMS}$
 $A_V = 0dB, R_L = 10k\Omega$

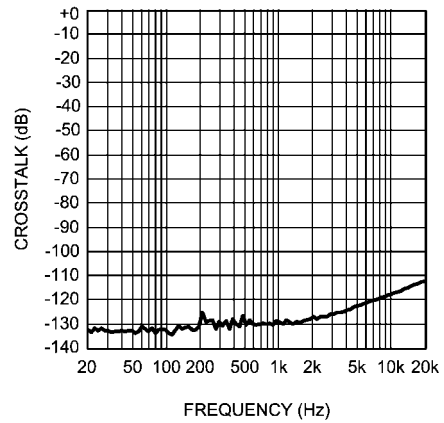

202151o0

Crosstalk vs Frequency
 $V_{CC} = 15V, V_{EE} = -15V, V_{OUT} = 10V_{RMS}$
 $A_V = 0dB, R_L = 10k\Omega$

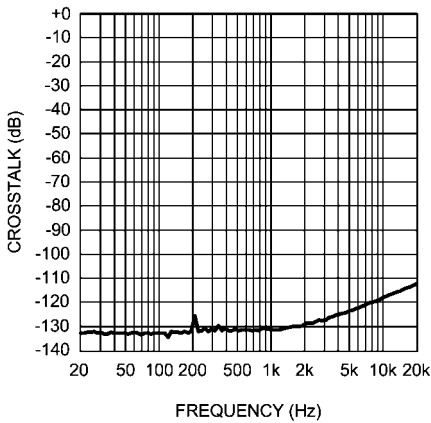

202151n7

Crosstalk vs Frequency
 $V_{CC} = 12V, V_{EE} = -12V, V_{OUT} = 3V_{RMS}$
 $A_V = 0dB, R_L = 10k\Omega$

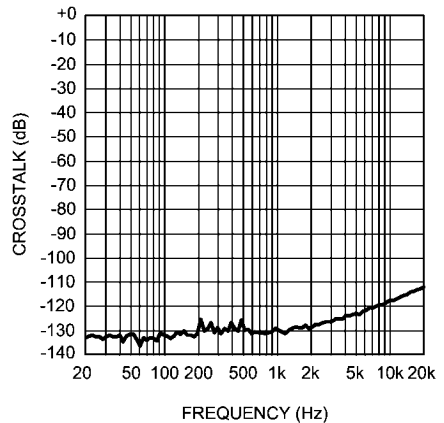

202151n9

Crosstalk vs Frequency
 $V_{CC} = 12V, V_{EE} = -12V, V_{OUT} = 10V_{RMS}$
 $A_V = 0dB, R_L = 10k\Omega$

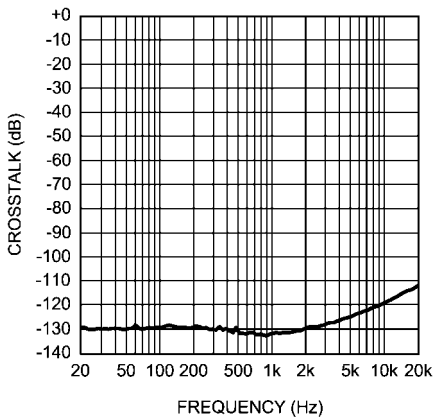

202151n6

Crosstalk vs Frequency
 $V_{CC} = 22V, V_{EE} = -22V, V_{OUT} = 3V_{RMS}$
 $A_V = 0dB, R_L = 10k\Omega$

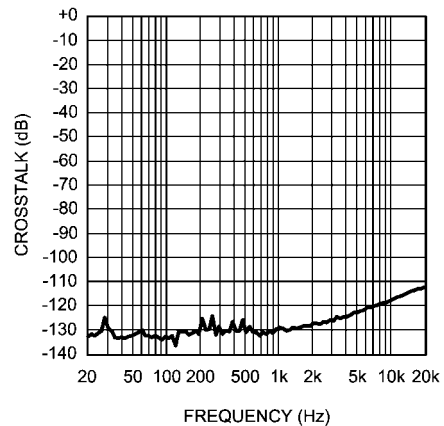

202151n5

Crosstalk vs Frequency
 $V_{CC} = 22V, V_{EE} = -22V, V_{OUT} = 10V_{RMS}$
 $A_V = 0dB, R_L = 10k\Omega$

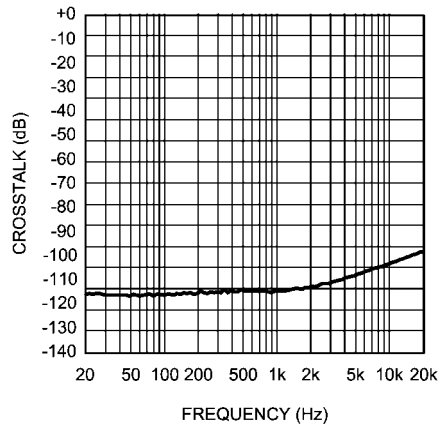

202151n3

Crosstalk vs Frequency
 $V_{CC} = 2.5V, V_{EE} = -2.5V, V_{OUT} = 1V_{RMS}$
 $A_V = 0dB, R_L = 10k\Omega$

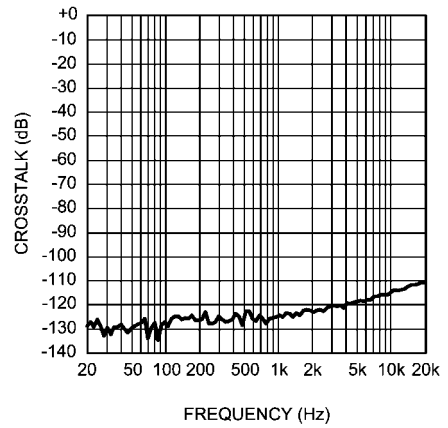

202151n4

PSRR+ vs Frequency
 $V_{CC} = 15V, V_{EE} = -15V$
 $R_L = 2k\Omega, V_{RIPPLE} = 200mVpp$

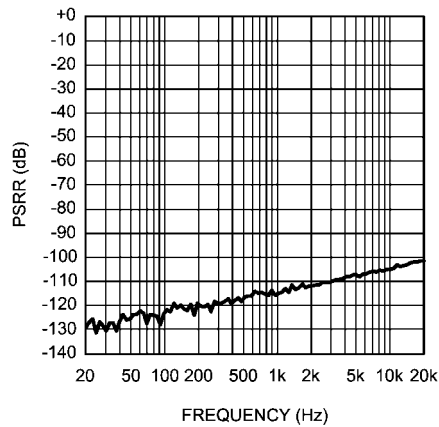

202151o1

PSRR- vs Frequency
 $V_{CC} = 15V, V_{EE} = -15V$
 $R_L = 2k\Omega, V_{RIPPLE} = 200mVpp$

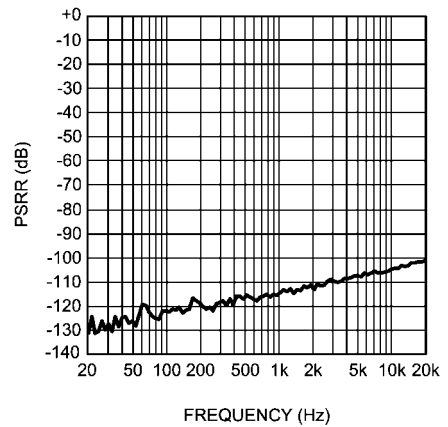

202151n2

PSRR+ vs Frequency
 $V_{CC} = 12V, V_{EE} = -12V$
 $R_L = 2k\Omega, V_{RIPPLE} = 200mVpp$

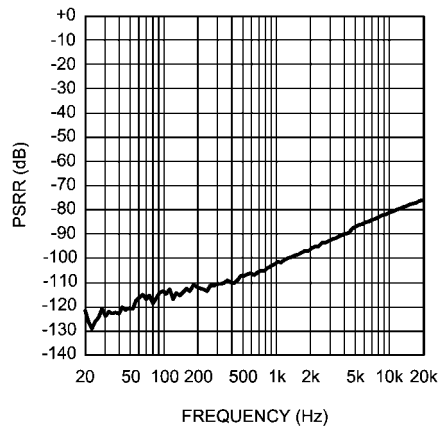

202151n1

PSRR- vs Frequency
 $V_{CC} = 12V, V_{EE} = -12V$
 $R_L = 2k\Omega, V_{RIPPLE} = 200mVpp$

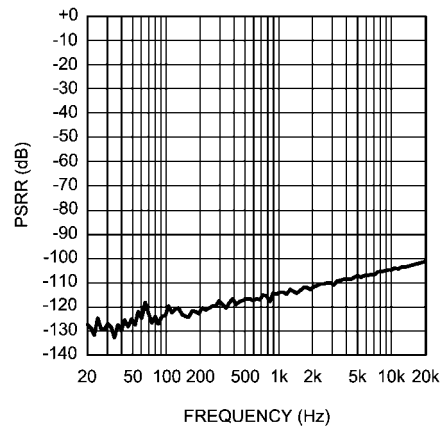

202151n0

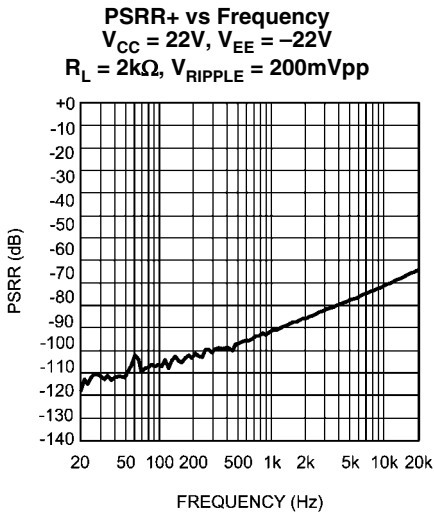

202151m9

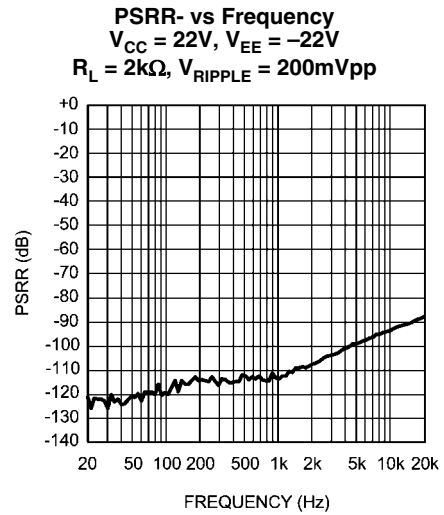

202151o3

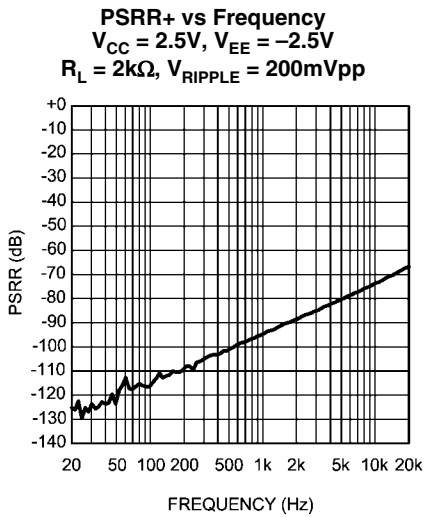

202151m8

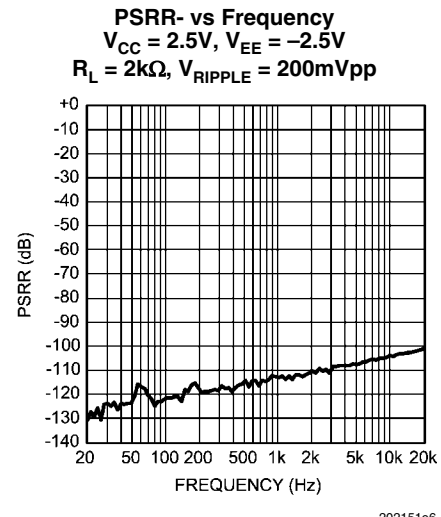

202151o6

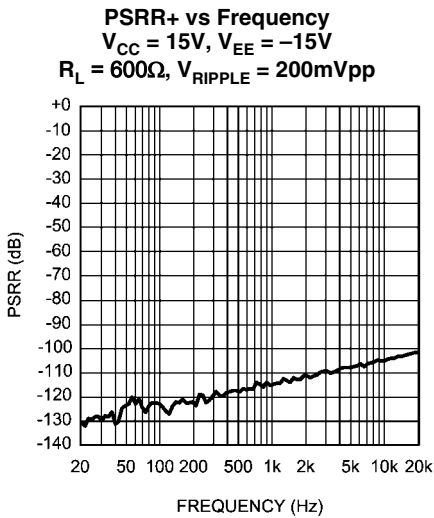

202151o2

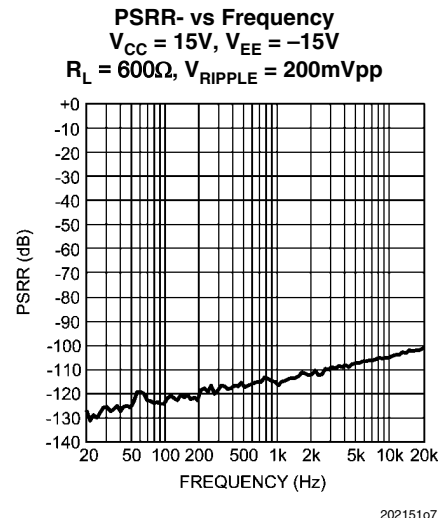

202151o7

PSRR+ vs Frequency
 $V_{CC} = 12V, V_{EE} = -12V$
 $R_L = 600\Omega, V_{RIPPLE} = 200mV_{pp}$

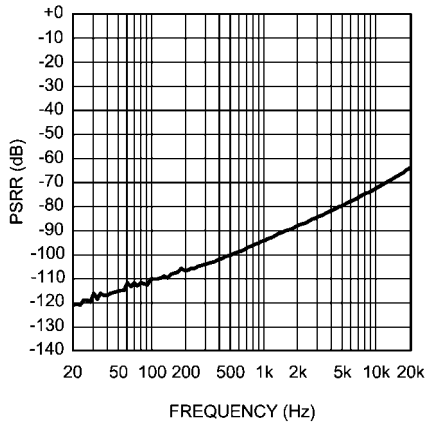

202151m7

PSRR- vs Frequency
 $V_{CC} = 12V, V_{EE} = -12V$
 $R_L = 600\Omega, V_{RIPPLE} = 200mV_{pp}$

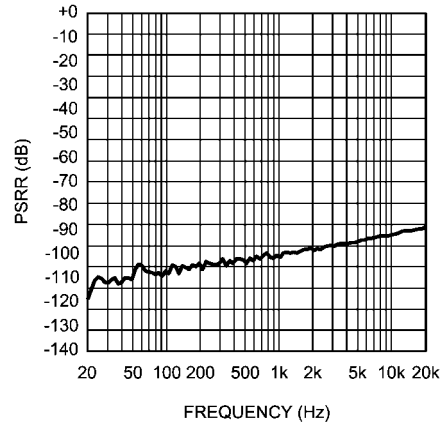

202151o4

PSRR+ vs Frequency
 $V_{CC} = 22V, V_{EE} = -22V$
 $R_L = 600\Omega, V_{RIPPLE} = 200mV_{pp}$

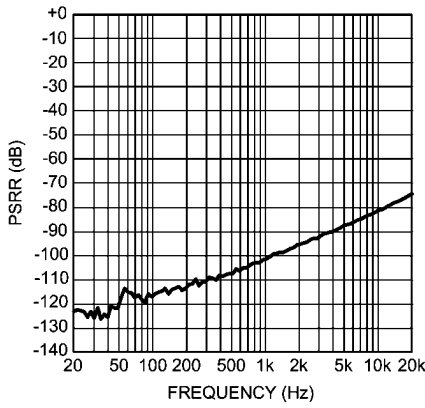

202151o5

PSRR- vs Frequency
 $V_{CC} = 22V, V_{EE} = -22V$
 $R_L = 600\Omega, V_{RIPPLE} = 200mV_{pp}$

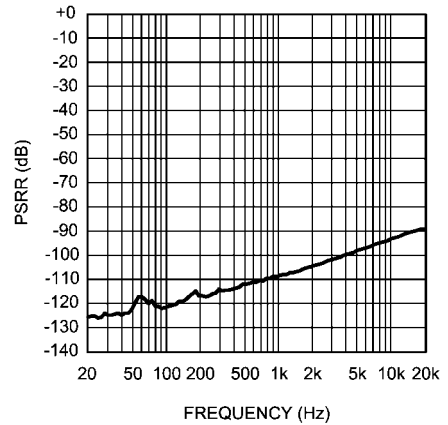

202151m6

PSRR+ vs Frequency
 $V_{CC} = 2.5V, V_{EE} = -2.5V$
 $R_L = 600\Omega, V_{RIPPLE} = 200mV_{pp}$

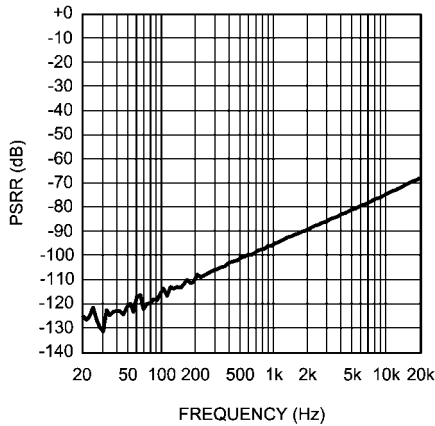

202151m5

PSRR- vs Frequency
 $V_{CC} = 2.5V, V_{EE} = -2.5V$
 $R_L = 600\Omega, V_{RIPPLE} = 200mV_{pp}$

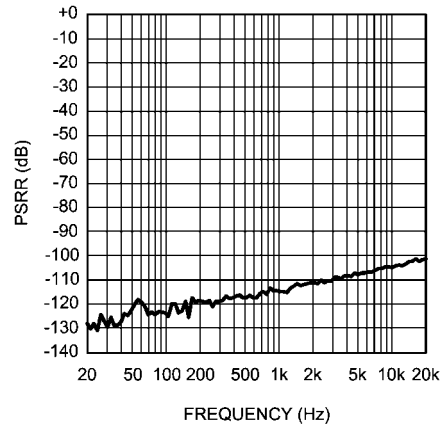

202151m4

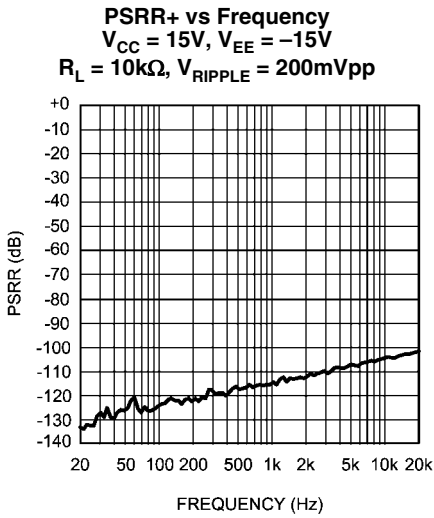

202151m3

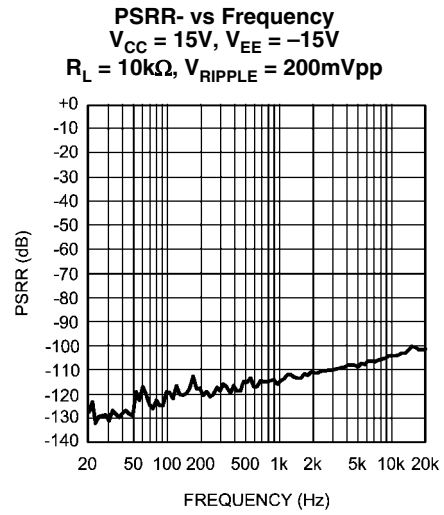

202151m2

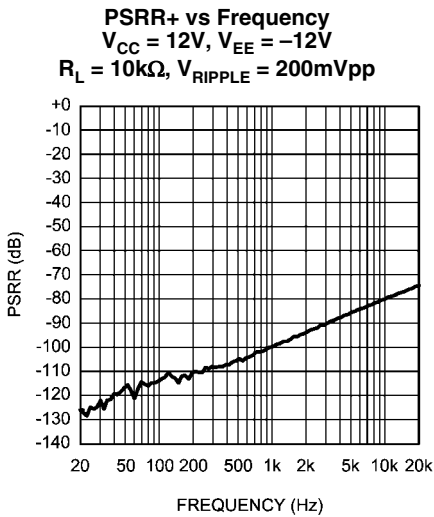

202151m1

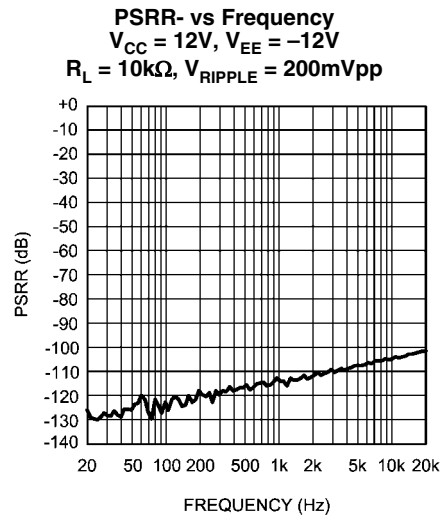

202151m0

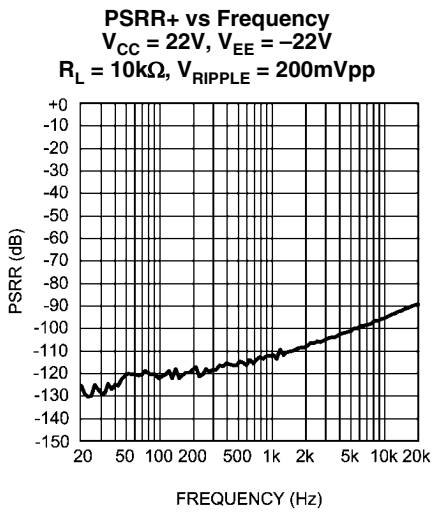

202151i9

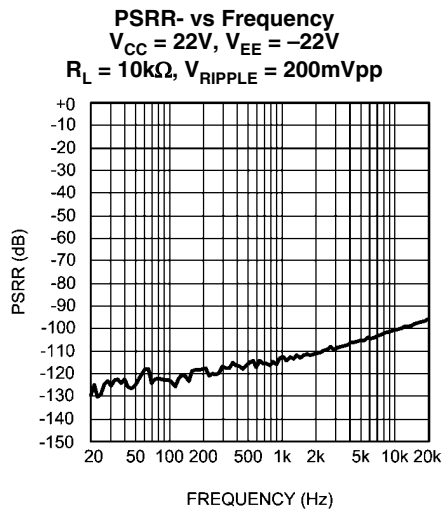

202151i8

PSRR+ vs Frequency
 $V_{CC} = 2.5V, V_{EE} = -2.5V$
 $R_L = 10k\Omega, V_{RIPPLE} = 200mV_{pp}$

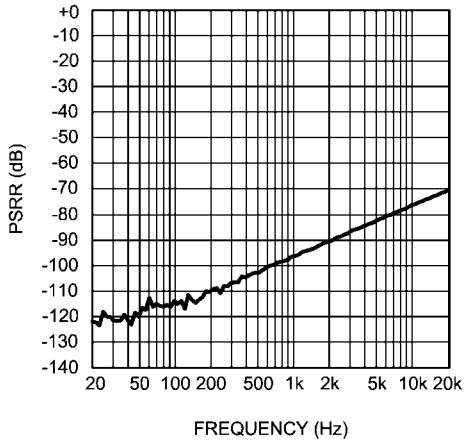

20215117

PSRR- vs Frequency
 $V_{CC} = 2.5V, V_{EE} = -2.5V$
 $R_L = 10k\Omega, V_{RIPPLE} = 200mV_{pp}$

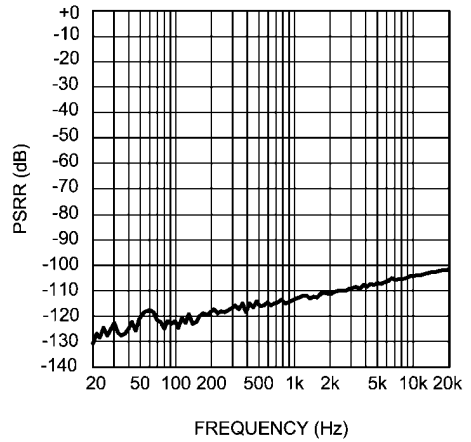

20215115

CMRR vs Frequency
 $V_{CC} = 15V, V_{EE} = -15V$
 $R_L = 2k\Omega$

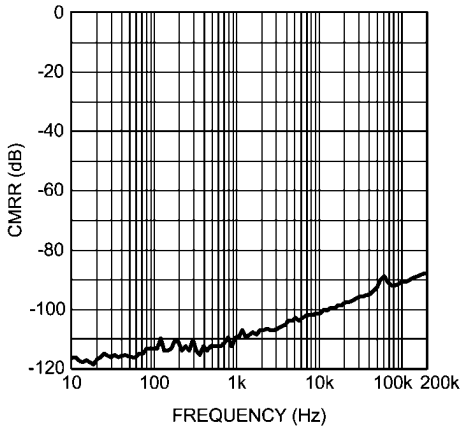

202151g0

CMRR vs Frequency
 $V_{CC} = 12V, V_{EE} = -12V$
 $R_L = 2k\Omega$

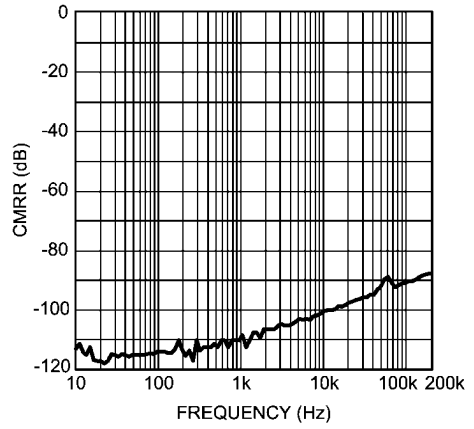

20215117

CMRR vs Frequency
 $V_{CC} = 22V, V_{EE} = -22V$
 $R_L = 2k\Omega$

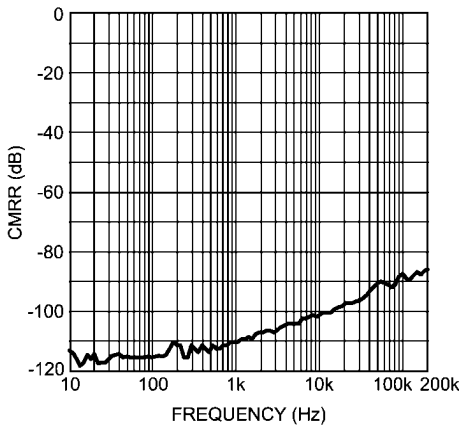

202151g3

CMRR vs Frequency
 $V_{CC} = 2.5V, V_{EE} = -2.5V$
 $R_L = 2k\Omega$

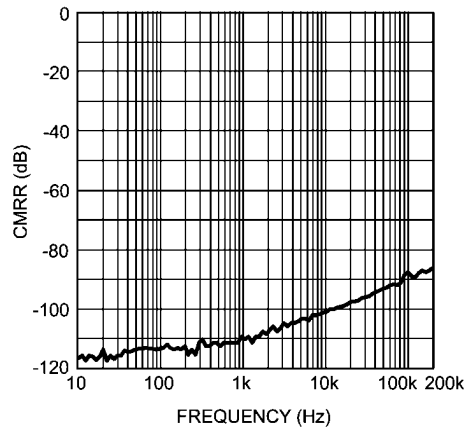

20215114

CMRR vs Frequency
 $V_{CC} = 15V, V_{EE} = -15V$
 $R_L = 600\Omega$

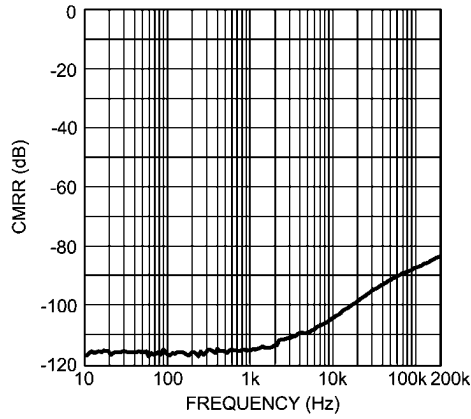

20215109

CMRR vs Frequency
 $V_{CC} = 12V, V_{EE} = -12V$
 $R_L = 600\Omega$

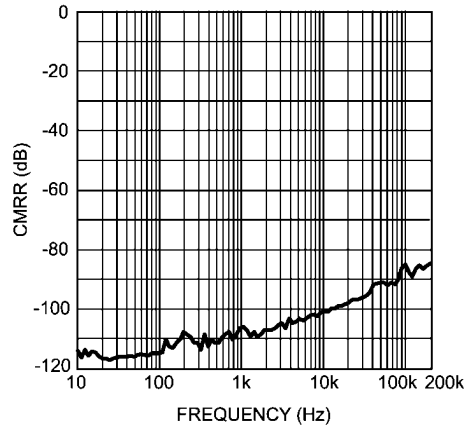

20215119

CMRR vs Frequency
 $V_{CC} = 22V, V_{EE} = -22V$
 $R_L = 600\Omega$

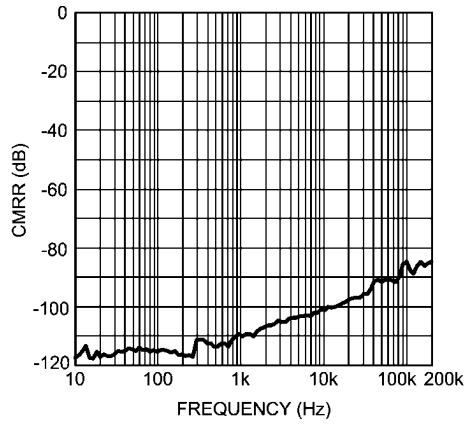

202151g5

CMRR vs Frequency
 $V_{CC} = 2.5V, V_{EE} = -2.5V$
 $R_L = 600\Omega$

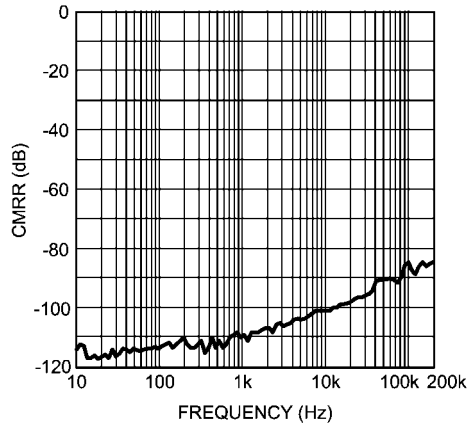

20215116

CMRR vs Frequency
 $V_{CC} = 15V, V_{EE} = -15V$
 $R_L = 10k\Omega$

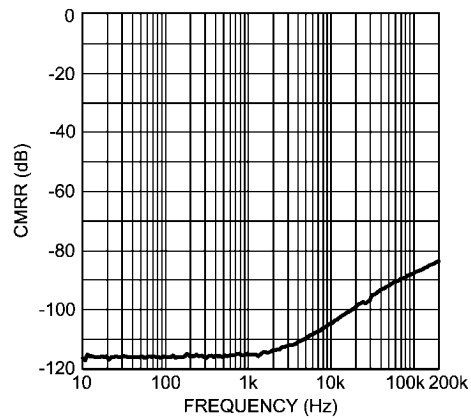

20215108

CMRR vs Frequency
 $V_{CC} = 12V, V_{EE} = -12V$
 $R_L = 10k\Omega$

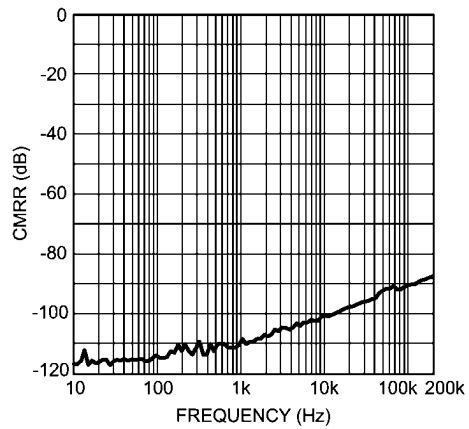

20215118

CMRR vs Frequency
 $V_{CC} = 22V, V_{EE} = -22V$
 $R_L = 10k\Omega$

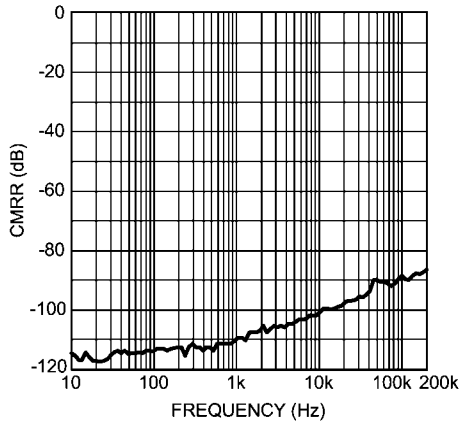

202151g4

CMRR vs Frequency
 $V_{CC} = 2.5V, V_{EE} = -2.5V$
 $R_L = 10k\Omega$

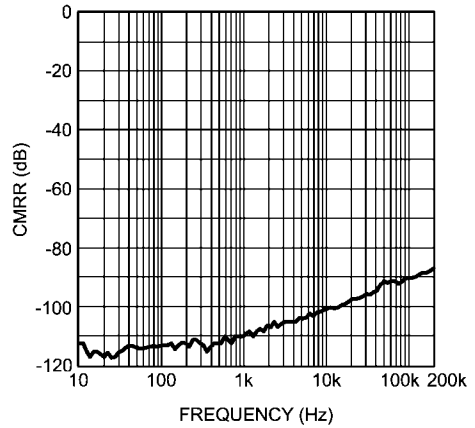

202151f5

Output Voltage vs Load Resistance
 $V_{CC} = 15V, V_{EE} = -15V$
 $THD+N = 1\%$

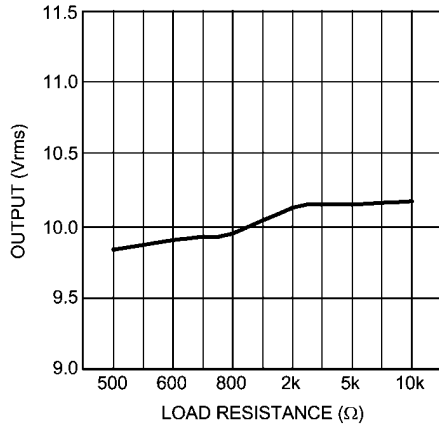

202151h1

Output Voltage vs Load Resistance
 $V_{CC} = 12V, V_{EE} = -12V$
 $THD+N = 1\%$

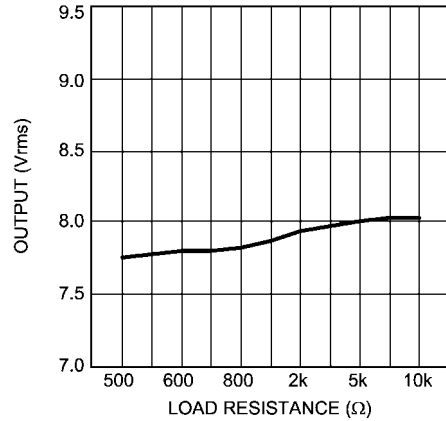

202151h0

Output Voltage vs Load Resistance
 $V_{CC} = 22V, V_{EE} = -22V$
 $THD+N = 1\%$

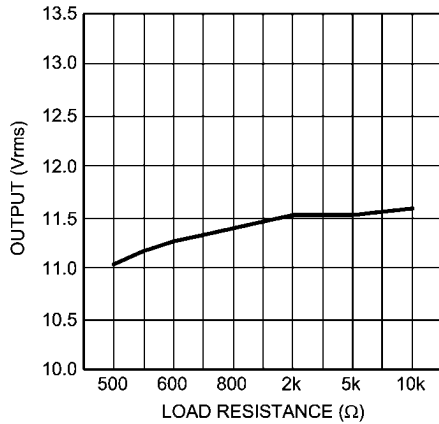

202151h2

Output Voltage vs Load Resistance
 $V_{CC} = 2.5V, V_{EE} = -2.5V$
 $THD+N = 1\%$

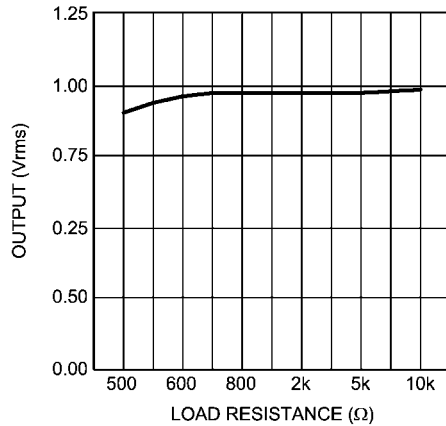

202151g9

Output Voltage vs Total Power Supply Voltage
 $R_L = 2k\Omega$, THD+N = 1%

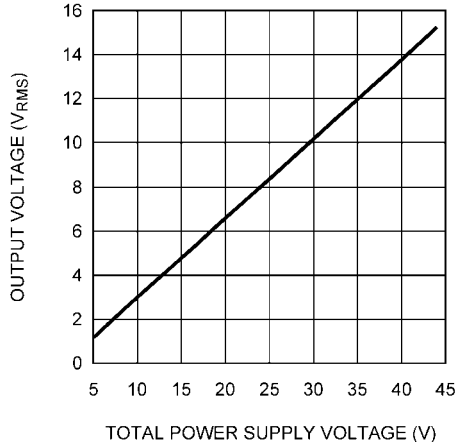

20215107

Output Voltage vs Total Power Supply Voltage
 $R_L = 600\Omega$, THD+N = 1%

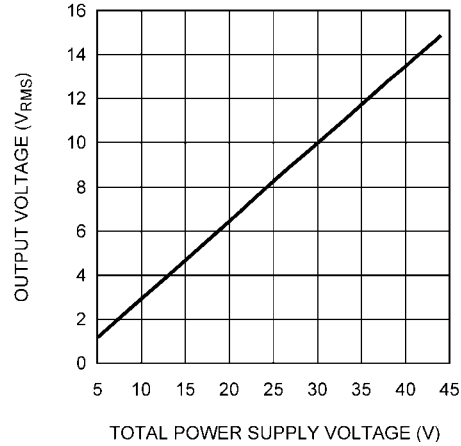

20215109

Output Voltage vs Total Power Supply Voltage
 $R_L = 10k\Omega$, THD+N = 1%

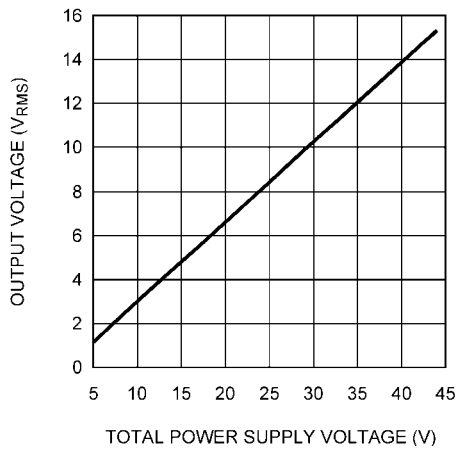

20215108

Power Supply Current vs Total Power Supply Voltage
 $R_L = 2k\Omega$

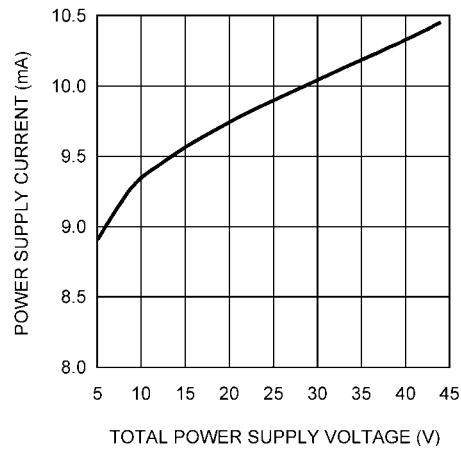

20215104

Power Supply Current vs Total Power Supply Voltage
 $R_L = 600\Omega$

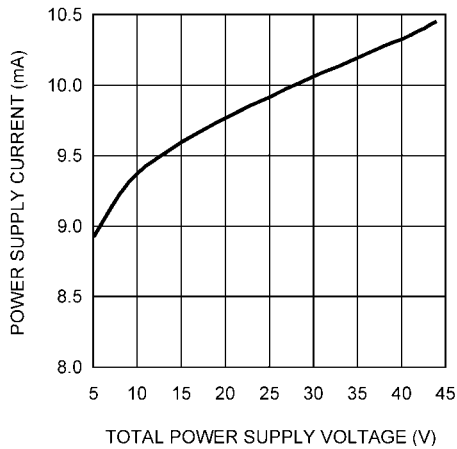

20215106

Power Supply Current vs Total Power Supply Voltage
 $R_L = 10k\Omega$

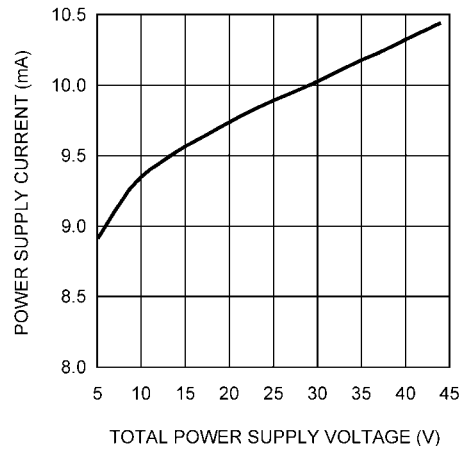

20215105

Full Power Bandwidth vs Frequency

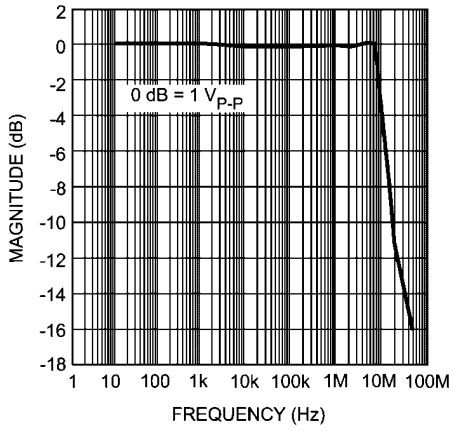

202151j0

Gain Phase vs Frequency

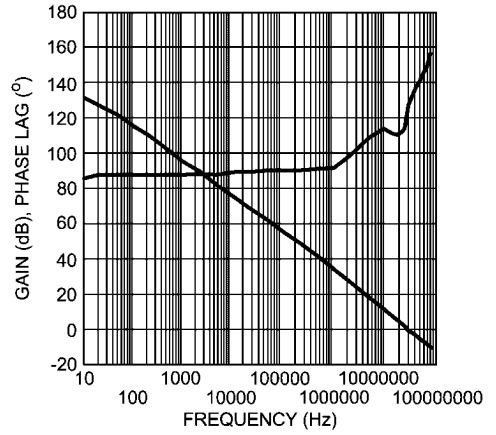

202151j1

Small-Signal Transient Response
 $A_V = 1, C_L = 10\text{pF}$

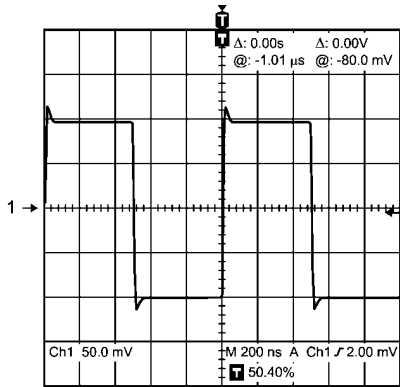

202151i7

Small-Signal Transient Response
 $A_V = 1, C_L = 100\text{pF}$

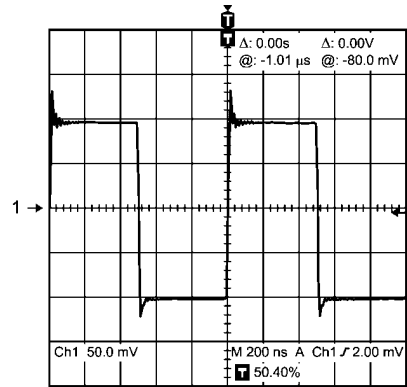

202151i8

Application Information

DISTORTION MEASUREMENTS

The vanishingly low residual distortion produced by LME49860 is below the capabilities of all commercially available equipment. This makes distortion measurements just slightly more difficult than simply connecting a distortion meter to the amplifier's inputs and outputs. The solution, however, is quite simple: an additional resistor. Adding this resistor extends the resolution of the distortion measurement equipment.

The LME49860's low residual distortion is an input referred internal error. As shown in Figure 1, adding the 10Ω resistor connected between the amplifier's inverting and non-inverting

inputs changes the amplifier's noise gain. The result is that the error signal (distortion) is amplified by a factor of 101. Although the amplifier's closed-loop gain is unaltered, the feedback available to correct distortion errors is reduced by 101, which means that measurement resolution increases by 101. To ensure minimum effects on distortion measurements, keep the value of R1 low as shown in Figure 1.

This technique is verified by duplicating the measurements with high closed loop gain and/or making the measurements at high frequencies. Doing so produces distortion components that are within the measurement equipment's capabilities. This datasheet's THD+N and IMD values were generated using the above described circuit connected to an Audio Precision System Two Cascade.

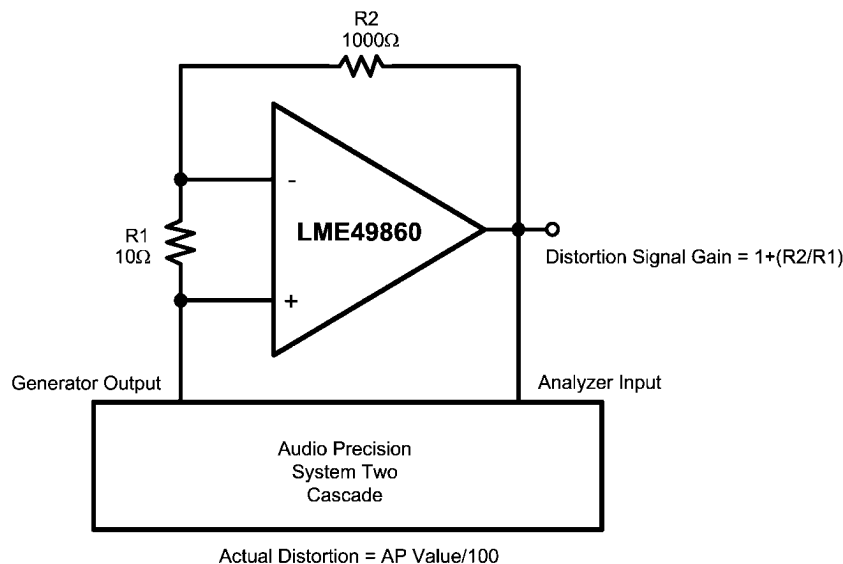

202151k4

FIGURE 1. THD+N and IMD Distortion Test Circuit

The LME49860 is a high speed op amp with excellent phase margin and stability. Capacitive loads up to 100pF will cause little change in the phase characteristics of the amplifiers and are therefore allowable.

Capacitive loads greater than 100pF must be isolated from the output. The most straightforward way to do this is to put

a resistor in series with the output. This resistor will also prevent excess power dissipation if the output is accidentally shorted.

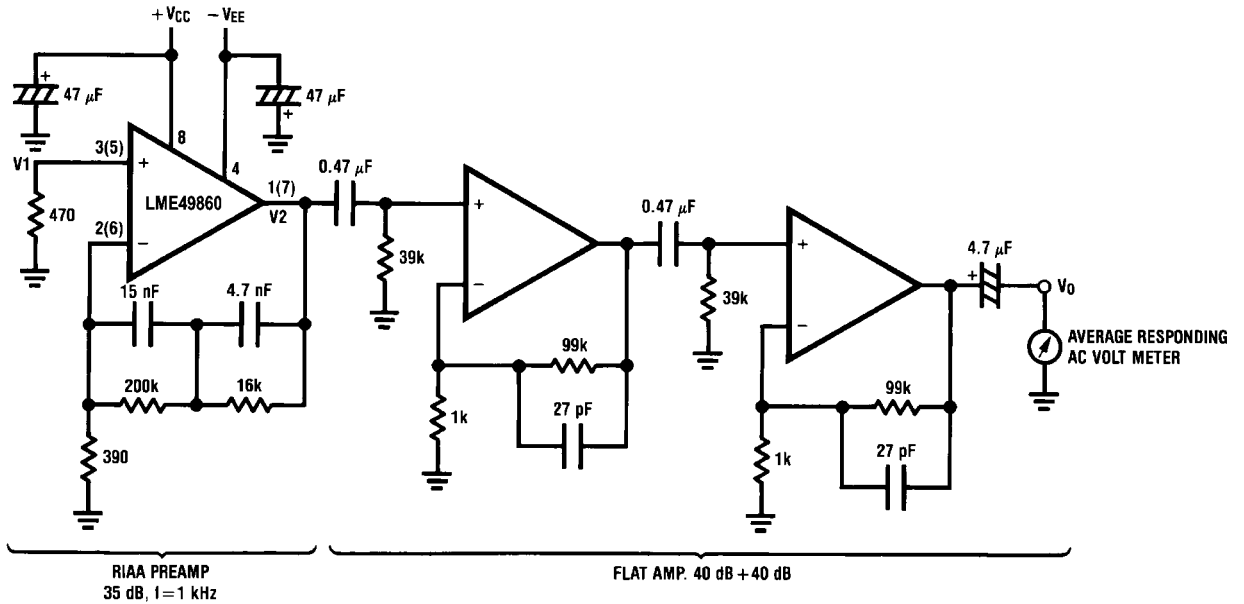

Complete shielding is required to prevent induced pick up from external sources. Always check with oscilloscope for power line noise.

20215127

Noise Measurement Circuit
Total Gain: 115 dB @f = 1 kHz
Input Referred Noise Voltage: $e_n = V_0/560,000$ (V)

RIAA Preamp Voltage Gain, RIAA Deviation vs Frequency

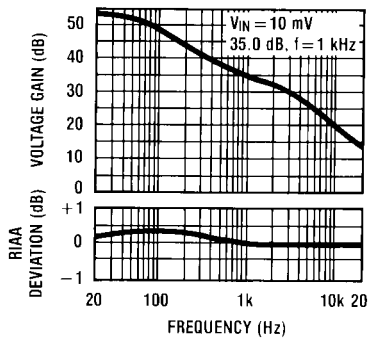

20215128

Flat Amp Voltage Gain vs Frequency

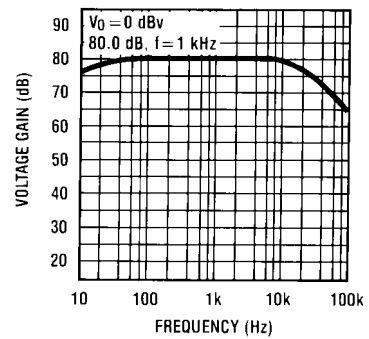

20215129

TYPICAL APPLICATIONS

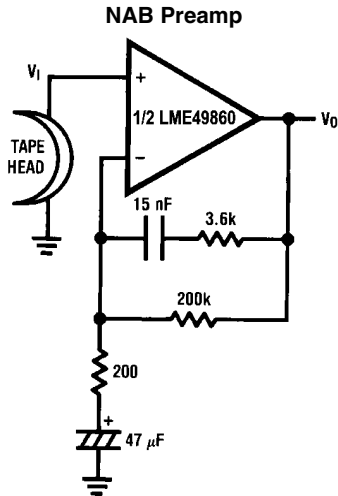

$A_v = 34.5$
 $F = 1 \text{ kHz}$
 $E_n = 0.38 \mu\text{V}$
 A Weighted

20215130

NAB Preamp Voltage Gain vs Frequency

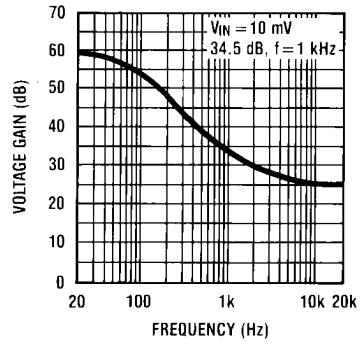

20215131

Balanced to Single Ended Converter

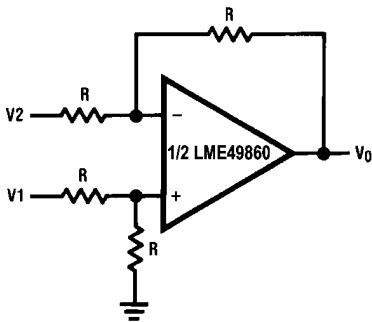

$V_o = V1 - V2$

20215132

Adder/Subtractor

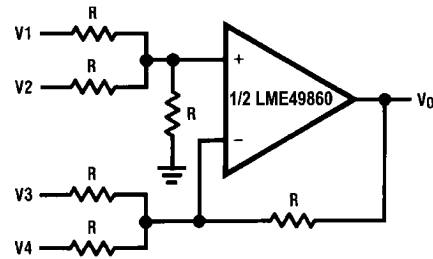

$V_o = V1 + V2 - V3 - V4$

20215133

Sine Wave Oscillator

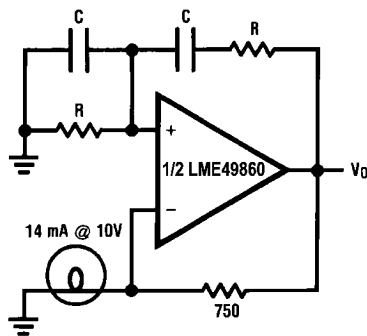

20215134

$f_o = \frac{1}{2\pi RC}$

Second Order High Pass Filter (Butterworth)

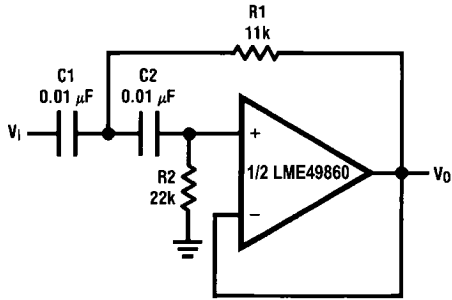

20215135

if $C1 = C2 = C$

$$R1 = \frac{\sqrt{2}}{2\omega_0 C}$$

$$R2 = 2 \cdot R1$$

Illustration is $f_0 = 1 \text{ kHz}$

Second Order Low Pass Filter (Butterworth)

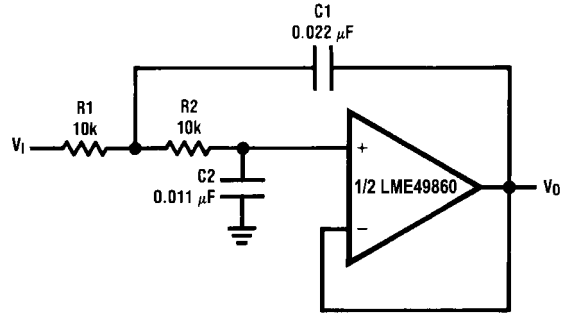

20215136

if $R1 = R2 = R$

$$C1 = \frac{\sqrt{2}}{\omega_0 R}$$

$$C2 = \frac{C1}{2}$$

Illustration is $f_0 = 1 \text{ kHz}$

State Variable Filter

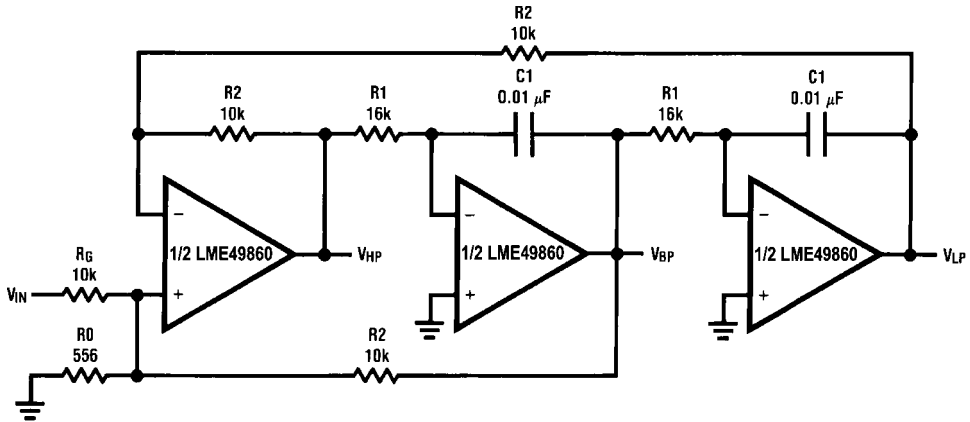

20215137

$$f_0 = \frac{1}{2\pi C1 R1}, Q = \frac{1}{2} \left(1 + \frac{R2}{R0} + \frac{R2}{RG} \right), A_{BP} = Q A_{LP} = Q A_{LH} = \frac{R2}{RG}$$

Illustration is $f_0 = 1 \text{ kHz}, Q = 10, A_{BP} = 1$

AC/DC Converter

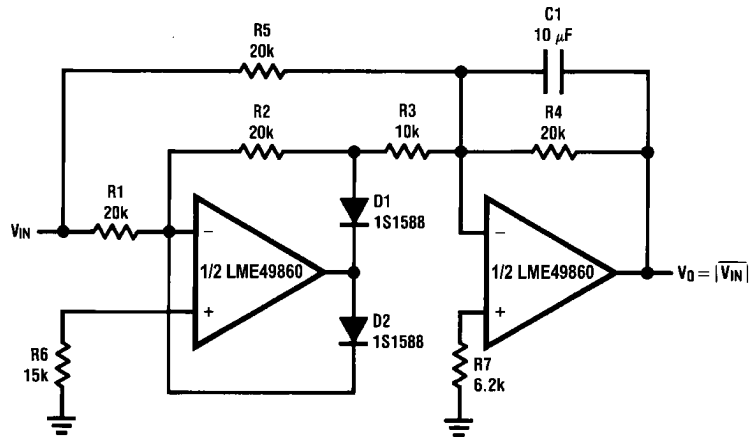

20215138

2 Channel Panning Circuit (Pan Pot)

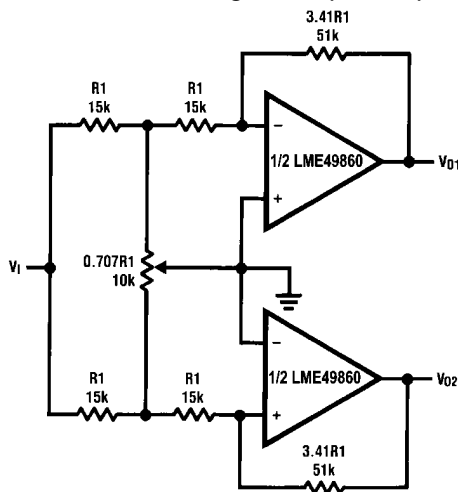

20215139

Line Driver

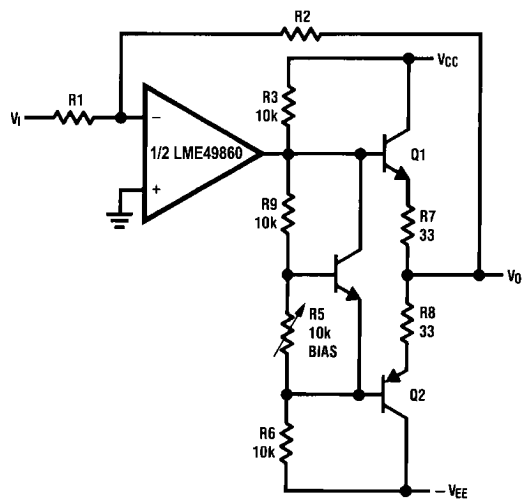

20215140

Tone Control

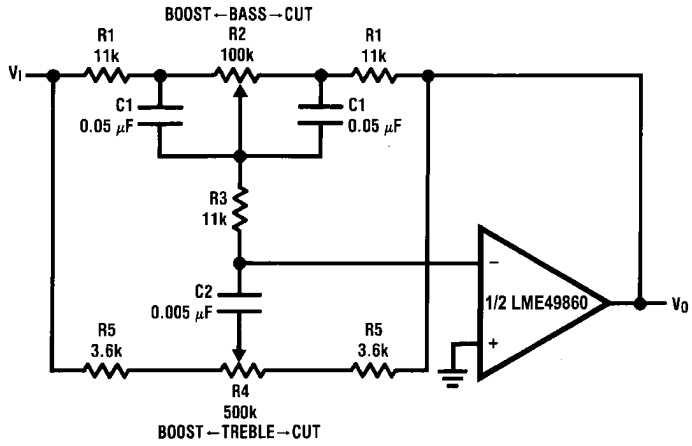

20215141

$$f_L = \frac{1}{2\pi R_2 C_1}, f_{LB} = \frac{1}{2\pi R_1 C_1}$$

$$f_H = \frac{1}{2\pi R_5 C_2}, f_{HB} = \frac{1}{2\pi (R_1 + R_5 + 2R_3) C_2}$$

Illustration is:

$f_L = 32 \text{ Hz}, f_{LB} = 320 \text{ Hz}$
 $f_H = 11 \text{ kHz}, f_{HB} = 1.1 \text{ kHz}$

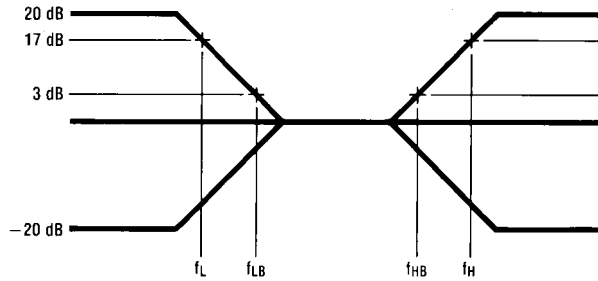

20215142

RIAA Preamp

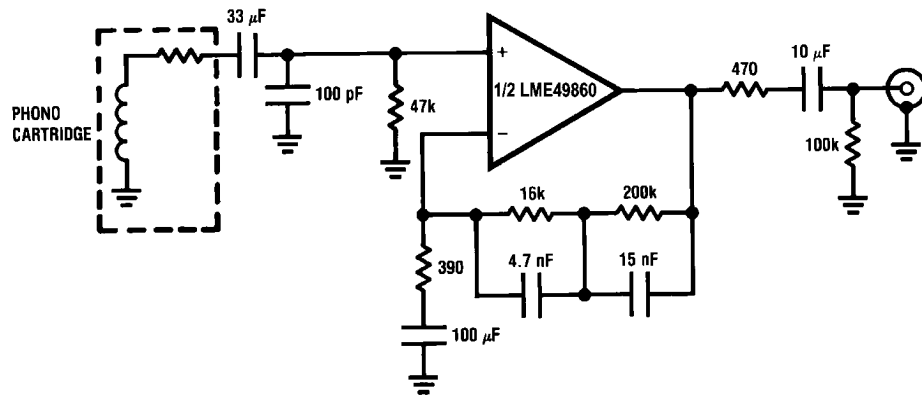

20215103

$A_v = 35 \text{ dB}$
 $E_n = 0.33 \mu\text{V}$
 $S/N = 90 \text{ dB}$
 $f = 1 \text{ kHz}$
 A Weighted
 A Weighted, $V_{IN} = 10 \text{ mV}$

@f = 1 kHz

Balanced Input Mic Amp

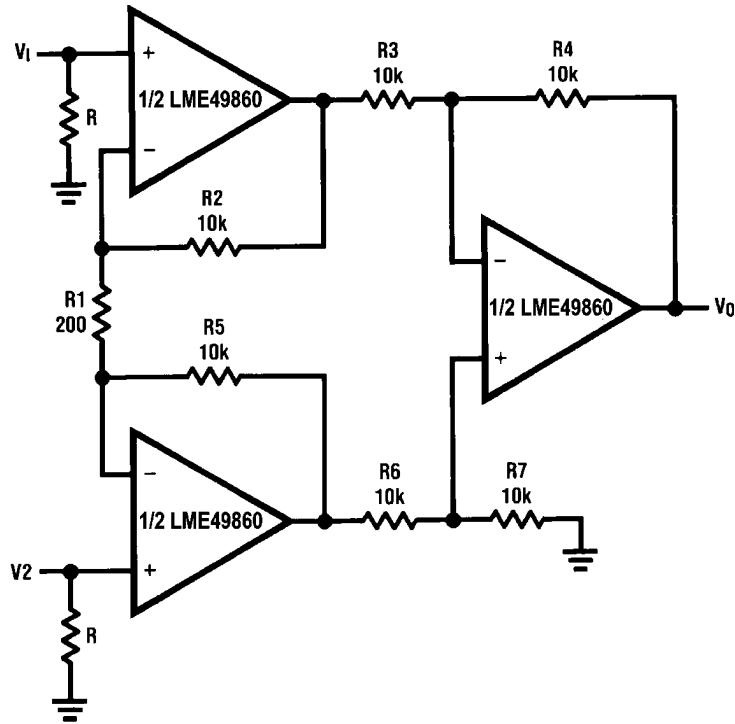

20215143

If $R2 = R5, R3 = R6, R4 = R7$

$$V_0 = \left(1 + \frac{2R_2}{R_1}\right) \frac{R_4}{R_3} (V_2 - V_1)$$

Illustration is:
 $V_0 = 101(V_2 - V_1)$

10 Band Graphic Equalizer

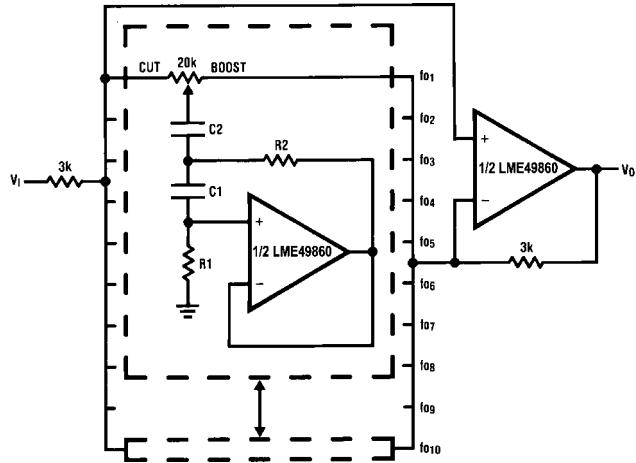

20215144

fo (Hz)	C ₁	C ₂	R ₁	R ₂
32	0.12μF	4.7μF	75kΩ	500Ω
64	0.056μF	3.3μF	68kΩ	510Ω
125	0.033μF	1.5μF	62kΩ	510Ω
250	0.015μF	0.82μF	68kΩ	470Ω
500	8200pF	0.39μF	62kΩ	470Ω
1k	3900pF	0.22μF	68kΩ	470Ω
2k	2000pF	0.1μF	68kΩ	470Ω
4k	1100pF	0.056μF	62kΩ	470Ω
8k	510pF	0.022μF	68kΩ	510Ω
16k	330pF	0.012μF	51kΩ	510Ω

Note 9: At volume of change = ±12 dB

Q = 1.7

Reference: "AUDIO/RADIO HANDBOOK", National Semiconductor, 1980, Page 2-61

Revision History

Rev	Date	Description
1.0	06/01/07	Initial release.
1.1	06/11/07	Added the LME49860MA and LME49860NA Top Mark Information.

Physical Dimensions inches (millimeters) unless otherwise noted

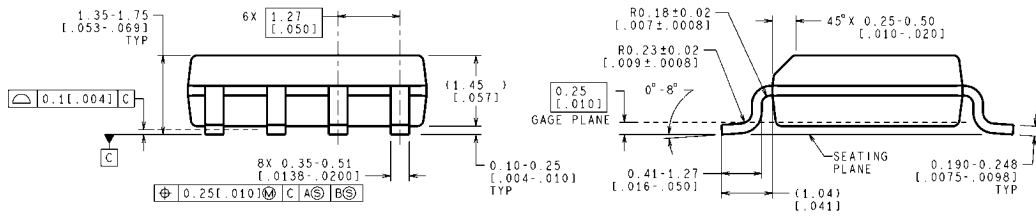
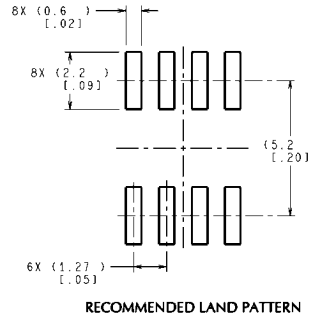
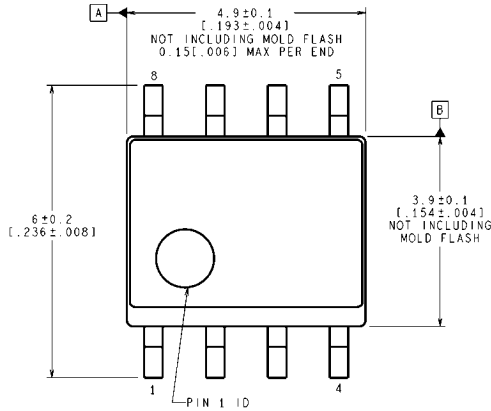

CONTROLLING DIMENSION IS MILLIMETER
VALUES IN [] ARE INCHES
DIMENSIONS IN () FOR REFERENCE ONLY

M08A (Rev L)

Narrow SOIC Package
Order Number LME49860MA
NS Package Number M08A

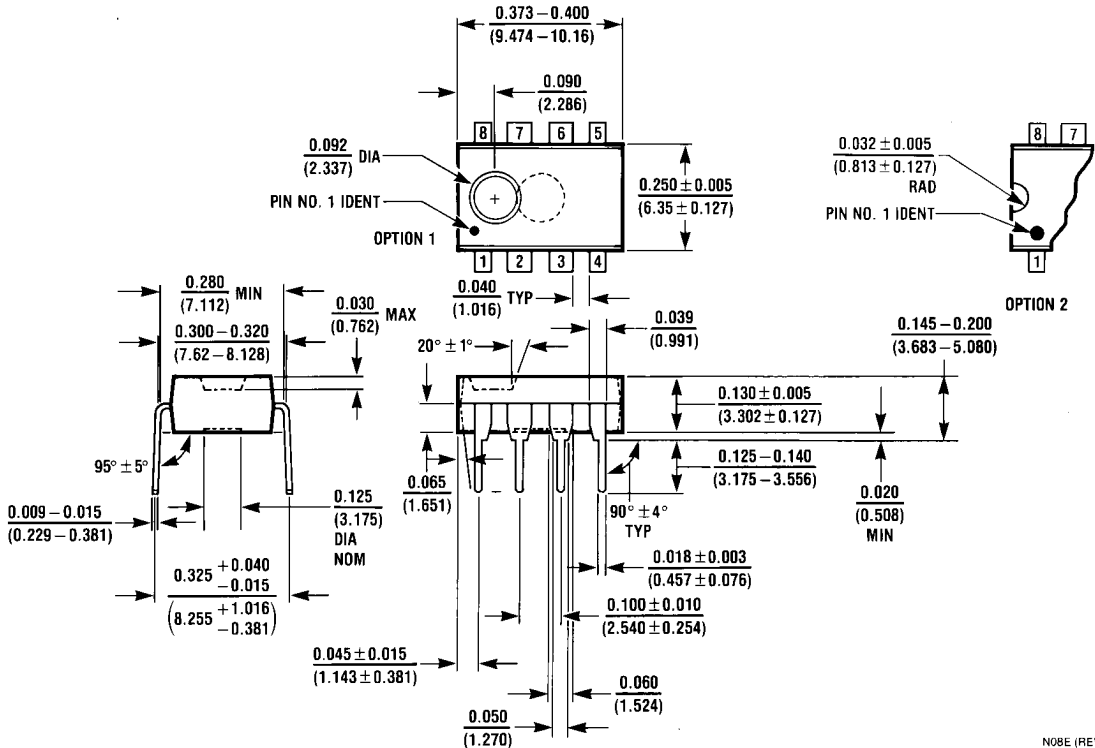

Dual-In-Line Package
Order Number LME49860NA
NS Package Number N08E

N08E (REV F)

Notes

LME49860

Notes

THE CONTENTS OF THIS DOCUMENT ARE PROVIDED IN CONNECTION WITH NATIONAL SEMICONDUCTOR CORPORATION ("NATIONAL") PRODUCTS. NATIONAL MAKES NO REPRESENTATIONS OR WARRANTIES WITH RESPECT TO THE ACCURACY OR COMPLETENESS OF THE CONTENTS OF THIS PUBLICATION AND RESERVES THE RIGHT TO MAKE CHANGES TO SPECIFICATIONS AND PRODUCT DESCRIPTIONS AT ANY TIME WITHOUT NOTICE. NO LICENSE, WHETHER EXPRESS, IMPLIED, ARISING BY ESTOPPEL OR OTHERWISE, TO ANY INTELLECTUAL PROPERTY RIGHTS IS GRANTED BY THIS DOCUMENT.

TESTING AND OTHER QUALITY CONTROLS ARE USED TO THE EXTENT NATIONAL DEEMS NECESSARY TO SUPPORT NATIONAL'S PRODUCT WARRANTY. EXCEPT WHERE MANDATED BY GOVERNMENT REQUIREMENTS, TESTING OF ALL PARAMETERS OF EACH PRODUCT IS NOT NECESSARILY PERFORMED. NATIONAL ASSUMES NO LIABILITY FOR APPLICATIONS ASSISTANCE OR BUYER PRODUCT DESIGN. BUYERS ARE RESPONSIBLE FOR THEIR PRODUCTS AND APPLICATIONS USING NATIONAL COMPONENTS. PRIOR TO USING OR DISTRIBUTING ANY PRODUCTS THAT INCLUDE NATIONAL COMPONENTS, BUYERS SHOULD PROVIDE ADEQUATE DESIGN, TESTING AND OPERATING SAFEGUARDS.

EXCEPT AS PROVIDED IN NATIONAL'S TERMS AND CONDITIONS OF SALE FOR SUCH PRODUCTS, NATIONAL ASSUMES NO LIABILITY WHATSOEVER, AND NATIONAL DISCLAIMS ANY EXPRESS OR IMPLIED WARRANTY RELATING TO THE SALE AND/OR USE OF NATIONAL PRODUCTS INCLUDING LIABILITY OR WARRANTIES RELATING TO FITNESS FOR A PARTICULAR PURPOSE, MERCHANTABILITY, OR INFRINGEMENT OF ANY PATENT, COPYRIGHT OR OTHER INTELLECTUAL PROPERTY RIGHT.

LIFE SUPPORT POLICY

NATIONAL'S PRODUCTS ARE NOT AUTHORIZED FOR USE AS CRITICAL COMPONENTS IN LIFE SUPPORT DEVICES OR SYSTEMS WITHOUT THE EXPRESS PRIOR WRITTEN APPROVAL OF THE CHIEF EXECUTIVE OFFICER AND GENERAL COUNSEL OF NATIONAL SEMICONDUCTOR CORPORATION. As used herein:

Life support devices or systems are devices which (a) are intended for surgical implant into the body, or (b) support or sustain life and whose failure to perform when properly used in accordance with instructions for use provided in the labeling can be reasonably expected to result in a significant injury to the user. A critical component is any component in a life support device or system whose failure to perform can be reasonably expected to cause the failure of the life support device or system or to affect its safety or effectiveness.

National Semiconductor and the National Semiconductor logo are registered trademarks of National Semiconductor Corporation. All other brand or product names may be trademarks or registered trademarks of their respective holders.

Copyright© 2007 National Semiconductor Corporation

For the most current product information visit us at www.national.com



National Semiconductor Americas Customer Support Center
 Email: new.feedback@nsc.com
 Tel: 1-800-272-9959

National Semiconductor Europe Customer Support Center
 Fax: +49 (0) 180-530-85-86
 Email: europe.support@nsc.com
 Deutsch Tel: +49 (0) 69 9508 6208
 English Tel: +49 (0) 870 24 0 2171
 Français Tel: +33 (0) 1 41 91 8790

National Semiconductor Asia Pacific Customer Support Center
 Email: ap.support@nsc.com

National Semiconductor Japan Customer Support Center
 Fax: 81-3-5639-7507
 Email: jpn.feedback@nsc.com
 Tel: 81-3-5639-7560