

# MJW21193 (PNP) MJW21194 (NPN)

## Silicon Power Transistors

The MJW21193 and MJW21194 utilize Perforated Emitter technology and are specifically designed for high power audio output, disk head positioners and linear applications.

### Features

- Total Harmonic Distortion Characterized
- High DC Current Gain –  
 $h_{FE} = 20 \text{ Min @ } I_C = 8 \text{ Adc}$
- Excellent Gain Linearity
- High SOA: 2.25 A, 80 V, 1 Second
- Pb-Free Packages are Available

### MAXIMUM RATINGS

Rating	Symbol	Value	Unit
Collector–Emitter Voltage	$V_{CEO}$	250	Vdc
Collector–Base Voltage	$V_{CBO}$	400	Vdc
Emitter–Base Voltage	$V_{EBO}$	5.0	Vdc
Collector–Emitter Voltage – 1.5 V	$V_{CEX}$	400	Vdc
Collector Current – Continuous – Peak (Note 1)	$I_C$	16 30	Adc
Base Current – Continuous	$I_B$	5.0	Adc
Total Power Dissipation @ $T_C = 25^\circ\text{C}$ Derate Above $25^\circ\text{C}$	$P_D$	200 1.43	W W/ $^\circ\text{C}$
Operating and Storage Junction Temperature Range	$T_J, T_{stg}$	– 65 to +150	$^\circ\text{C}$

### THERMAL CHARACTERISTICS

Characteristic	Symbol	Max	Unit
Thermal Resistance, Junction–to–Case	$R_{\theta JC}$	0.7	$^\circ\text{C}/\text{W}$
Thermal Resistance, Junction–to–Ambient	$R_{\theta JA}$	40	$^\circ\text{C}/\text{W}$

Stresses exceeding Maximum Ratings may damage the device. Maximum Ratings are stress ratings only. Functional operation above the Recommended Operating Conditions is not implied. Extended exposure to stresses above the Recommended Operating Conditions may affect device reliability.

1. Pulse Test: Pulse Width = 5  $\mu\text{s}$ , Duty Cycle  $\leq 10\%$ .



**ON Semiconductor®**

<http://onsemi.com>

**16 AMPERES  
COMPLEMENTARY SILICON  
POWER TRANSISTORS  
250 VOLTS, 200 WATTS**

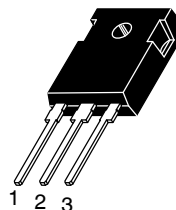

TO-247  
CASE 340L  
STYLE 3

### MARKING DIAGRAM

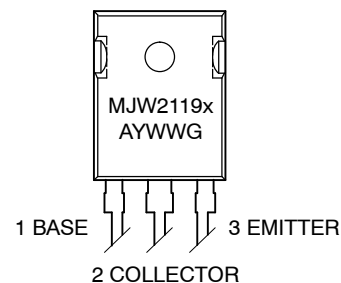

x = 3 or 4  
A = Assembly Location  
Y = Year  
WW = Work Week  
G = Pb-Free Package

### ORDERING INFORMATION

Device	Package	Shipping
MJW21193	TO-247	30 Units/Rail
MJW21193G	TO-247 (Pb-Free)	30 Units/Rail
MJW21194	TO-247	30 Units/Rail
MJW21194G	TO-247 (Pb-Free)	30 Units/Rail

# MJW21193 (PNP) MJW21194 (NPN)

## ELECTRICAL CHARACTERISTICS (T<sub>C</sub> = 25°C unless otherwise noted)

Characteristic	Symbol	Min	Typ	Max	Unit
----------------	--------	-----	-----	-----	------

### OFF CHARACTERISTICS

Collector-Emitter Sustaining Voltage (I <sub>C</sub> = 100 mA <sub>dc</sub> , I <sub>B</sub> = 0)	V <sub>CEO(sus)</sub>	250	-	-	V <sub>dc</sub>
Collector Cutoff Current (V <sub>CE</sub> = 200 V <sub>dc</sub> , I <sub>B</sub> = 0)	I <sub>CEO</sub>	-	-	100	μA <sub>dc</sub>
Emitter Cutoff Current (V <sub>CE</sub> = 5 V <sub>dc</sub> , I <sub>C</sub> = 0)	I <sub>EBO</sub>	-	-	100	μA <sub>dc</sub>
Collector Cutoff Current (V <sub>CE</sub> = 250 V <sub>dc</sub> , V <sub>BE(off)</sub> = 1.5 V <sub>dc</sub> )	I <sub>CEx</sub>	-	-	100	μA <sub>dc</sub>

### SECOND BREAKDOWN

Second Breakdown Collector Current with Base Forward Biased (V <sub>CE</sub> = 50 V <sub>dc</sub> , t = 1 s (non-repetitive)) (V <sub>CE</sub> = 80 V <sub>dc</sub> , t = 1 s (non-repetitive))	I <sub>S/b</sub>	4.0 2.25	- -	- -	A <sub>dc</sub>
---	------------------	-------------	--------	--------	-----------------

### ON CHARACTERISTICS

DC Current Gain (I <sub>C</sub> = 8 A <sub>dc</sub> , V <sub>CE</sub> = 5 V <sub>dc</sub> ) (I <sub>C</sub> = 16 A <sub>dc</sub> , I <sub>B</sub> = 5 A <sub>dc</sub> )	h <sub>FE</sub>	20 8	- -	80 -	
Base-Emitter On Voltage (I <sub>C</sub> = 8 A <sub>dc</sub> , V <sub>CE</sub> = 5 V <sub>dc</sub> )	V <sub>BE(on)</sub>	-	-	2.2	V <sub>dc</sub>
Collector-Emitter Saturation Voltage (I <sub>C</sub> = 8 A <sub>dc</sub> , I <sub>B</sub> = 0.8 A <sub>dc</sub> ) (I <sub>C</sub> = 16 A <sub>dc</sub> , I <sub>B</sub> = 3.2 A <sub>dc</sub> )	V <sub>CE(sat)</sub>	- -	- -	1.4 4	V <sub>dc</sub>

### DYNAMIC CHARACTERISTICS

Total Harmonic Distortion at the Output V <sub>RMS</sub> = 28.3 V, f = 1 kHz, P <sub>LOAD</sub> = 100 W <sub>RMS</sub> (Matched pair h <sub>FE</sub> = 50 @ 5 A/5 V)	h <sub>FE</sub> unmatched h <sub>FE</sub> matched	T <sub>HD</sub>	- -	0.8 0.08	- -	%
Current Gain Bandwidth Product (I <sub>C</sub> = 1 A <sub>dc</sub> , V <sub>CE</sub> = 10 V <sub>dc</sub> , f <sub>test</sub> = 1 MHz)		f <sub>T</sub>	4	-	-	MHz
Output Capacitance (V <sub>CB</sub> = 10 V <sub>dc</sub> , I <sub>E</sub> = 0, f <sub>test</sub> = 1 MHz)		C <sub>ob</sub>	-	-	500	pF

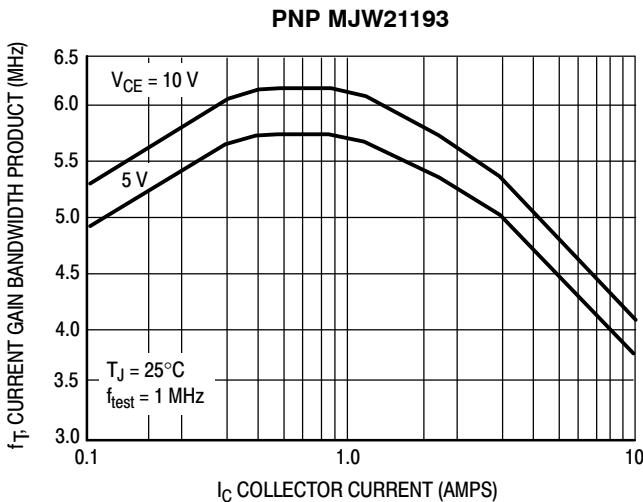

**Figure 1. Typical Current Gain Bandwidth Product**

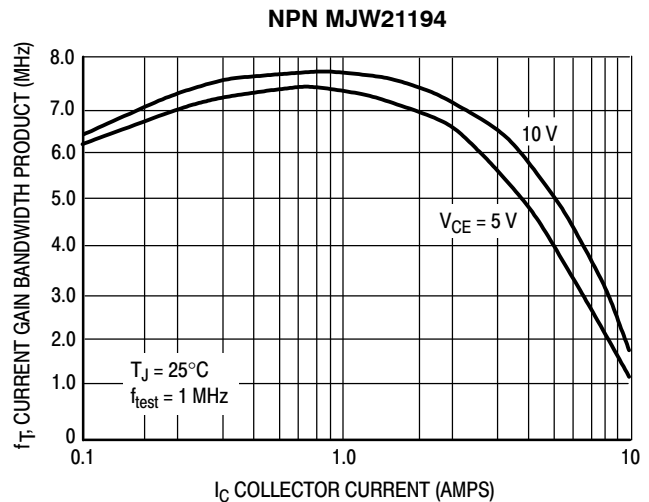

**Figure 2. Typical Current Gain Bandwidth Product**

# MJW21193 (PNP) MJW21194 (NPN)

## TYPICAL CHARACTERISTICS

PNP MJW21193

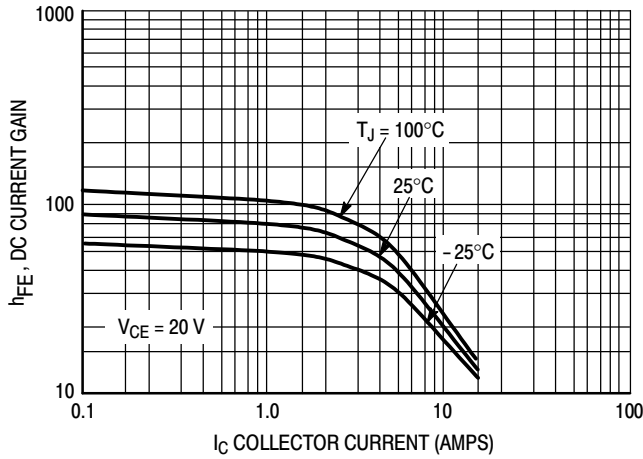

Figure 3. DC Current Gain,  $V_{CE} = 20\text{ V}$

NPN MJW21194

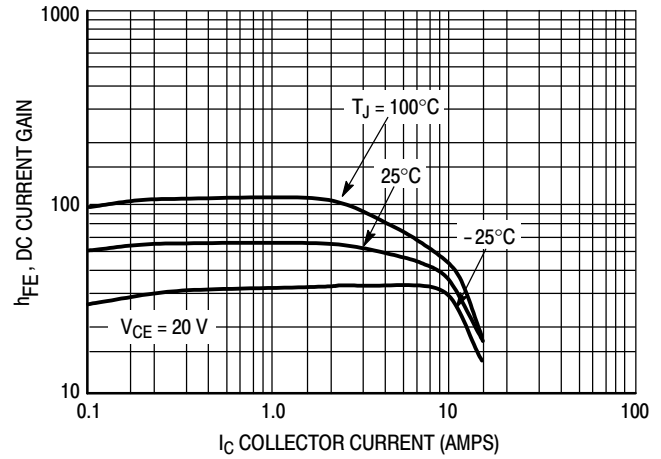

Figure 4. DC Current Gain,  $V_{CE} = 20\text{ V}$

PNP MJW21193

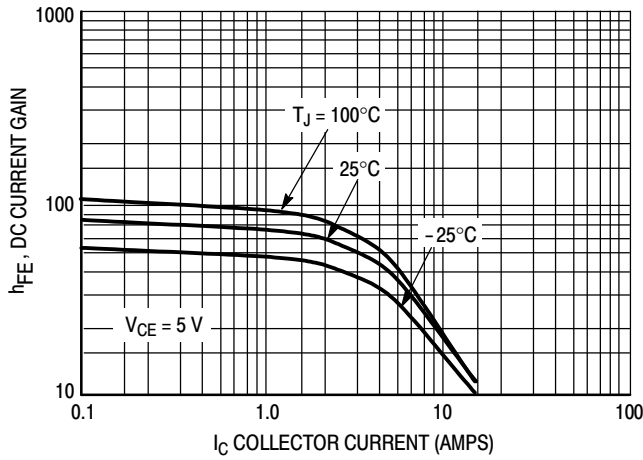

Figure 5. DC Current Gain,  $V_{CE} = 5\text{ V}$

NPN MJW21194

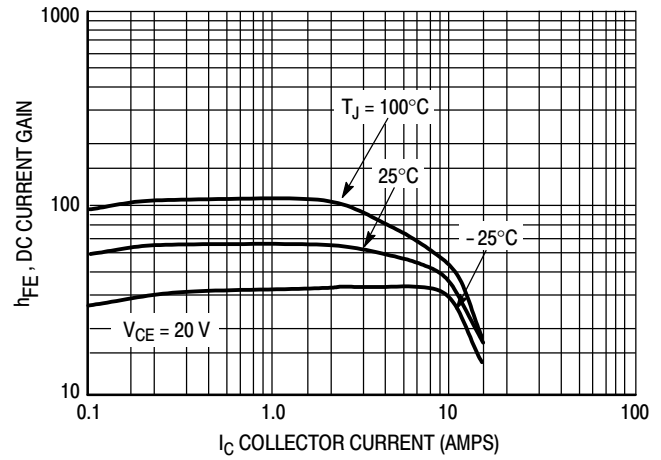

Figure 6. DC Current Gain,  $V_{CE} = 5\text{ V}$

PNP MJW21193

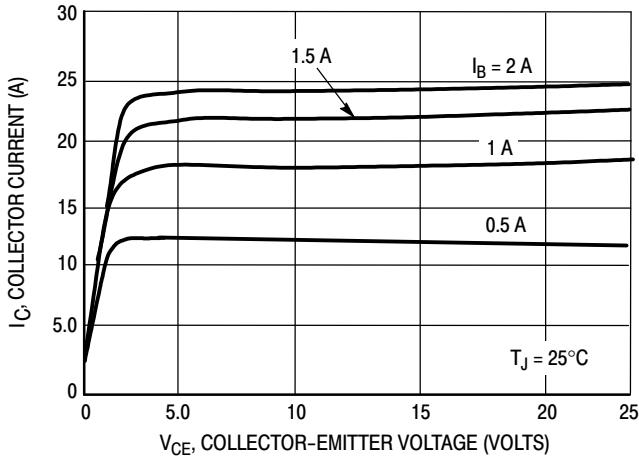

Figure 7. Typical Output Characteristics

NPN MJW21194

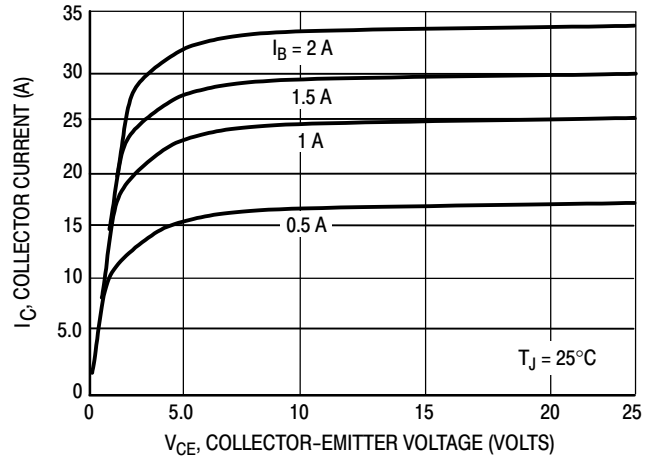
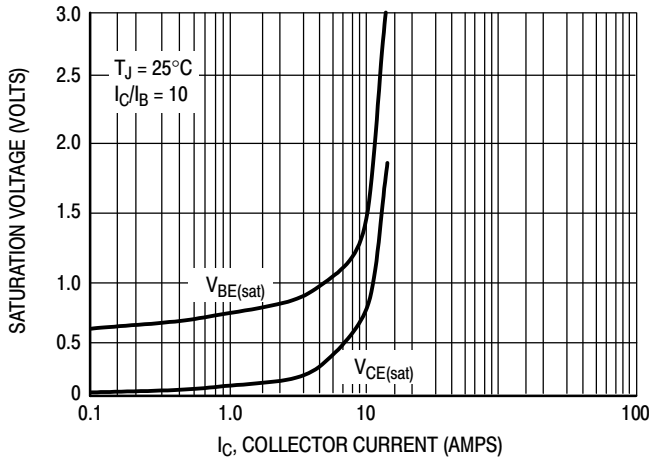

Figure 8. Typical Output Characteristics

# MJW21193 (PNP) MJW21194 (NPN)

## TYPICAL CHARACTERISTICS

**PNP MJW21193**



**Figure 9. Typical Saturation Voltages**

**NPN MJW21194**

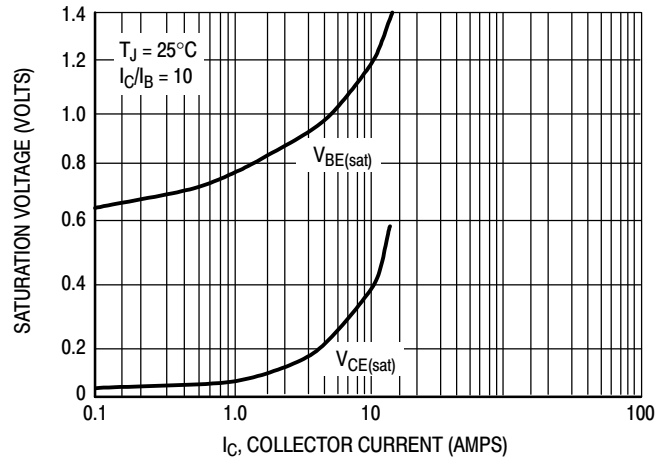

**Figure 10. Typical Saturation Voltages**

**PNP MJW21193**

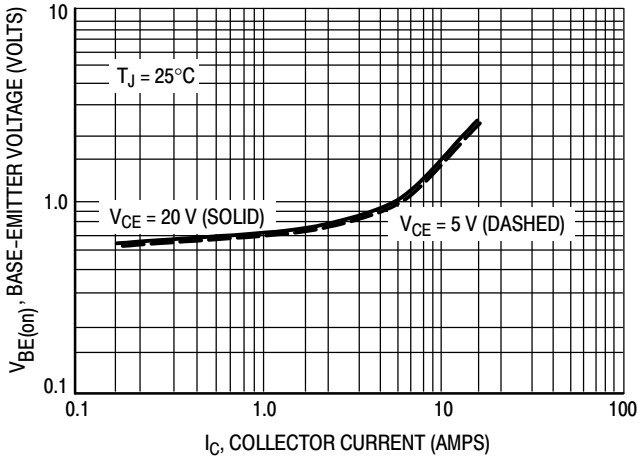

**Figure 11. Typical Base-Emitter Voltage**

**NPN MJW21194**

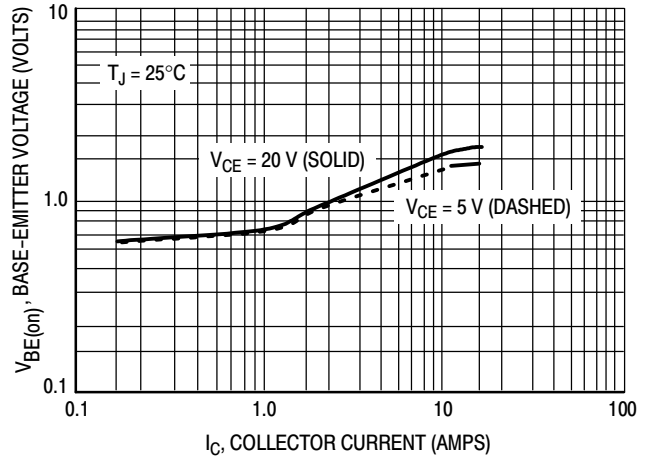

**Figure 12. Typical Base-Emitter Voltage**

**PNP MJW21193**

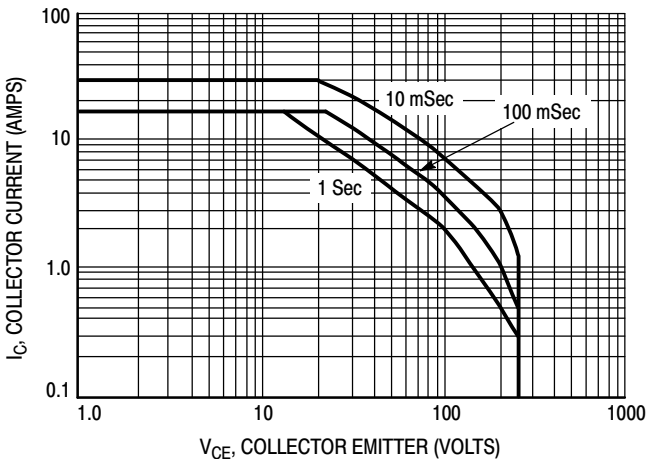

**Figure 13. Active Region Safe Operating Area**

**NPN MJW21194**

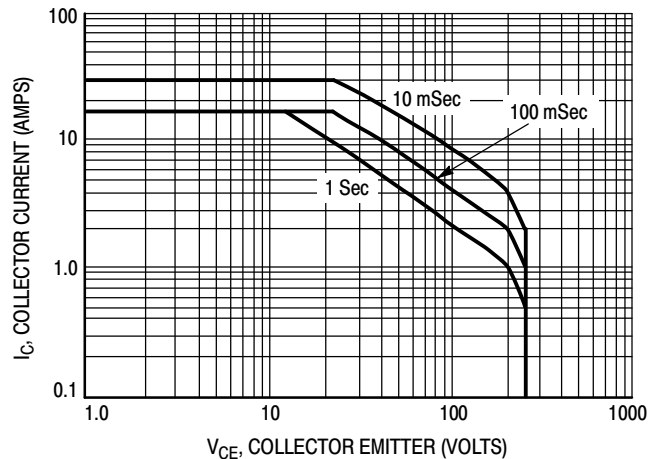

**Figure 14. Active Region Safe Operating Area**

## MJW21193 (PNP) MJW21194 (NPN)

There are two limitations on the power handling ability of a transistor; average junction temperature and secondary breakdown. Safe operating area curves indicate  $I_C - V_{CE}$  limits of the transistor that must be observed for reliable operation; i.e., the transistor must not be subjected to greater dissipation than the curves indicate.

The data of Figure 13 is based on  $T_{J(pk)} = 150^\circ\text{C}$ ;  $T_C$  is variable depending on conditions. At high case temperatures, thermal limitations will reduce the power that can be handled to values less than the limitations imposed by second breakdown.

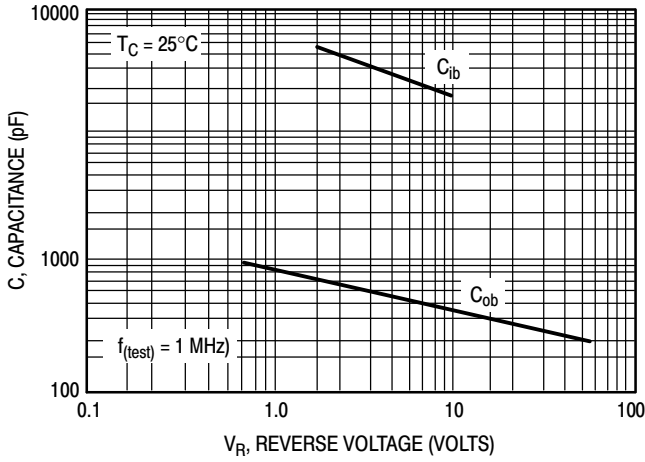

Figure 15. MJW21193 Typical Capacitance

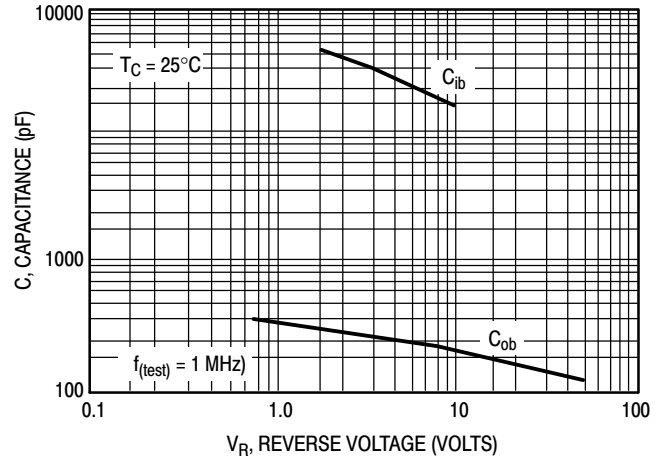

Figure 16. MJW21194 Typical Capacitance

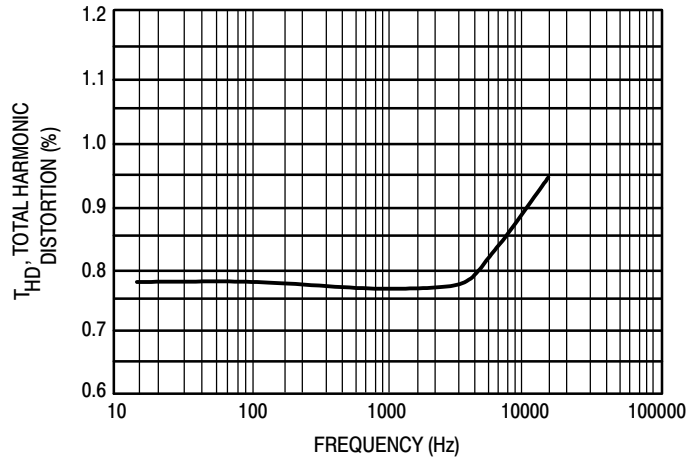

Figure 17. Typical Total Harmonic Distortion

# MJW21193 (PNP) MJW21194 (NPN)

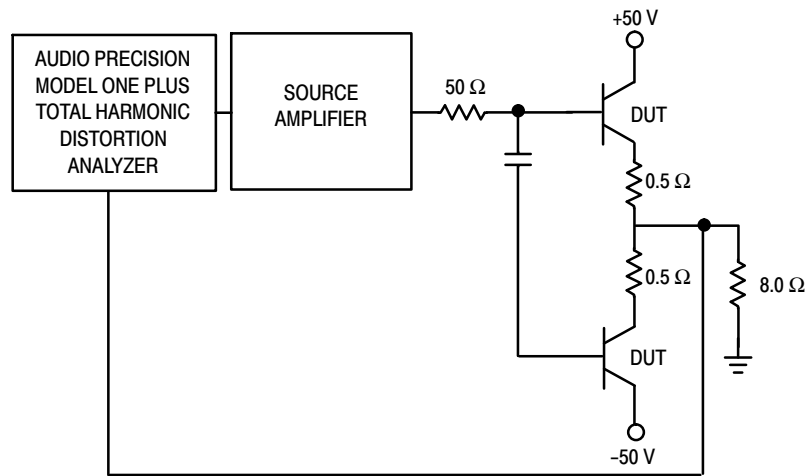
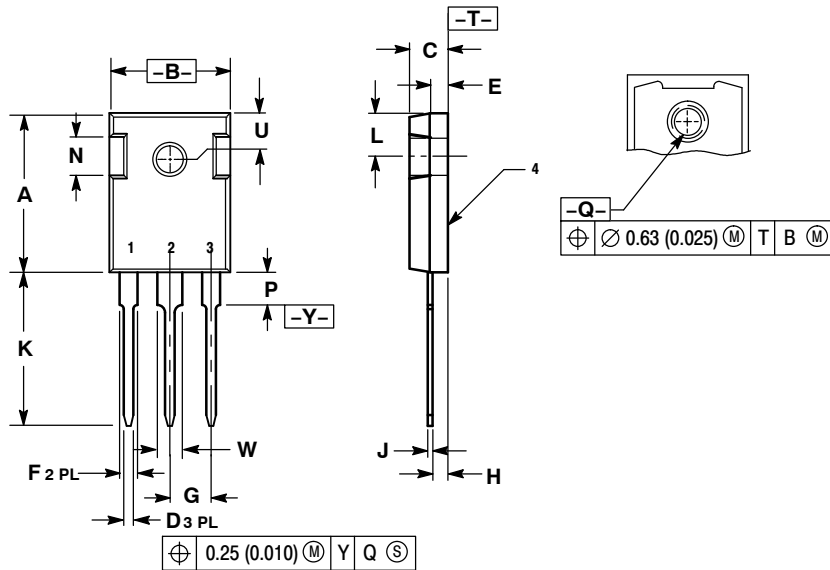

Figure 18. Total Harmonic Distortion Test Circuit

# MJW21193 (PNP) MJW21194 (NPN)

## PACKAGE DIMENSIONS

TO-247  
CASE 340L-02  
ISSUE E



- NOTES:  
1. DIMENSIONING AND TOLERANCING PER ANSI Y14.5M, 1982.  
2. CONTROLLING DIMENSION: MILLIMETER.

DIM	MILLIMETERS		INCHES	
	MIN	MAX	MIN	MAX
A	20.32	21.08	0.800	0.830
B	15.75	16.26	0.620	0.640
C	4.70	5.30	0.185	0.209
D	1.00	1.40	0.040	0.055
E	1.90	2.60	0.075	0.102
F	1.65	2.13	0.065	0.084
G	5.45 BSC		0.215 BSC	
H	1.50	2.49	0.059	0.098
J	0.40	0.80	0.016	0.031
K	19.81	20.83	0.780	0.820
L	5.40	6.20	0.212	0.244
N	4.32	5.49	0.170	0.216
P	---	4.50	---	0.177
Q	3.55	3.65	0.140	0.144
U	6.15 BSC		0.242 BSC	
W	2.87	3.12	0.113	0.123

- STYLE 3:  
1. BASE  
2. COLLECTOR  
3. EMITTER

ON Semiconductor and are registered trademarks of Semiconductor Components Industries, LLC (SCILLC). SCILLC reserves the right to make changes without further notice to any products herein. SCILLC makes no warranty, representation or guarantee regarding the suitability of its products for any particular purpose, nor does SCILLC assume any liability arising out of the application or use of any product or circuit, and specifically disclaims any and all liability, including without limitation special, consequential or incidental damages. "Typical" parameters which may be provided in SCILLC data sheets and/or specifications can and do vary in different applications and actual performance may vary over time. All operating parameters, including "Typicals" must be validated for each customer application by customer's technical experts. SCILLC does not convey any license under its patent rights nor the rights of others. SCILLC products are not designed, intended, or authorized for use as components in systems intended for surgical implant into the body, or other applications intended to support or sustain life, or for any other application in which the failure of the SCILLC product could create a situation where personal injury or death may occur. Should Buyer purchase or use SCILLC products for any such unintended or unauthorized application, Buyer shall indemnify and hold SCILLC and its officers, employees, subsidiaries, affiliates, and distributors harmless against all claims, costs, damages, and expenses, and reasonable attorney fees arising out of, directly or indirectly, any claim of personal injury or death associated with such unintended or unauthorized use, even if such claim alleges that SCILLC was negligent regarding the design or manufacture of the part. SCILLC is an Equal Opportunity/Affirmative Action Employer. This literature is subject to all applicable copyright laws and is not for resale in any manner.

### PUBLICATION ORDERING INFORMATION

**LITERATURE FULFILLMENT:**  
Literature Distribution Center for ON Semiconductor  
P.O. Box 5163, Denver, Colorado 80217 USA  
**Phone:** 303-675-2175 or 800-344-3860 Toll Free USA/Canada  
**Fax:** 303-675-2176 or 800-344-3867 Toll Free USA/Canada  
**Email:** orderlit@onsemi.com

**N. American Technical Support:** 800-282-9855 Toll Free USA/Canada  
**Europe, Middle East and Africa Technical Support:**  
Phone: 421 33 790 2910  
**Japan Customer Focus Center**  
Phone: 81-3-5773-3850

**ON Semiconductor Website:** [www.onsemi.com](http://www.onsemi.com)  
**Order Literature:** <http://www.onsemi.com/orderlit>

For additional information, please contact your local Sales Representative