

MJL4281A (NPN) MJL4302A (PNP)

Preferred Device

Complementary NPN-PNP Silicon Power Bipolar Transistors

The MJL4281A and MJL4302A are PowerBase™ power transistors for high power audio.

- 350 V Collector–Emitter Sustaining Voltage
- Gain Complementary:
 - Gain Linearity from 100 mA to 5 A
 - High Gain – 80 to 240
 - $h_{FE} = 50$ (min) @ $I_C = 8$ A
- Low Harmonic Distortion
- High Safe Operation Area – 1.0 A/100 V @ 1 Second
- High f_T

MAXIMUM RATINGS ($T_J = 25^\circ\text{C}$ unless otherwise noted)

Rating	Symbol	Value	Unit
Collector–Emitter Voltage	V_{CEO}	350	Vdc
Collector–Base Voltage	V_{CBO}	350	Vdc
Emitter–Base Voltage	V_{EBO}	5.0	Vdc
Collector–Emitter Voltage – 1.5 V	V_{CEX}	350	Vdc
Collector Current – Continuous – Peak (Note 1)	I_C	15 30	Adc
Base Current – Continuous	I_B	1.5	Adc
Total Power Dissipation @ $T_C = 25^\circ\text{C}$ Derate Above 25°C	P_D	230 1.84	Watts $^\circ\text{C}/\text{W}$
Operating and Storage Junction Temperature Range	T_J, T_{stg}	– 65 to +150	$^\circ\text{C}$

THERMAL CHARACTERISTICS

Characteristic	Symbol	Max	Unit
Thermal Resistance, Junction to Case	$R_{\theta JC}$	0.54	$^\circ\text{C}/\text{W}$

1. Pulse Test: Pulse Width = 5 ms, Duty Cycle < 10%.



ON Semiconductor®

<http://onsemi.com>

**15 AMPERES
COMPLEMENTARY
SILICON POWER
TRANSISTORS
350 VOLTS
230 WATTS**

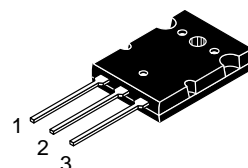

TO-264
CASE 340G
STYLE 2

MARKING DIAGRAM

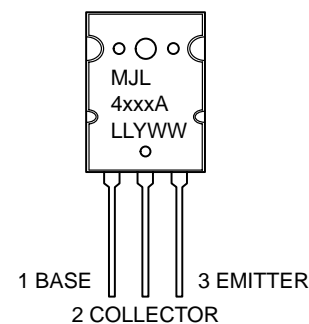

MJL4xxxA = Device Code
xxx = 281 OR 302
LL = Location Code
Y = Year
WW = Work Week

ORDERING INFORMATION

Device	Package	Shipping
MJL4281A	TO-264	25 Units/Rail
MJL4302A	TO-264	25 Units/Rail

Preferred devices are recommended choices for future use and best overall value.

MJL4281A (NPN) MJL4302A (PNP)

ELECTRICAL CHARACTERISTICS (T_C = 25°C unless otherwise noted)

Characteristic	Symbol	Min	Max	Unit
OFF CHARACTERISTICS				
Collector Emitter Sustaining Voltage (I _C = 50 mA, I _B = 0)	V _{CE(sus)}	350		Vdc
Collector Cut-off Current (V _{CE} = 200 V, I _B = 0)	I _{CEO}		100	μAdc
Collector Cutoff Current (V _{CB} = 350 Vdc, I _E = 0)	I _{CB0}	–	50	μAdc
Emitter Cutoff Current (V _{EB} = 5.0 Vdc, I _C = 0)	I _{EBO}	–	5.0	μAdc
SECOND BREAKDOWN				
Second Breakdown Collector with Base Forward Biased (V _{CE} = 50 Vdc, t = 1.0 s (non-repetitive) (V _{CE} = 100 Vdc, t = 1.0 s (non-repetitive)	I _{S/b}	4.5 1.0	– –	Adc
ON CHARACTERISTICS				
DC Current Gain (I _C = 100 mAdc, V _{CE} = 5.0 Vdc) (I _C = 1.0 Adc, V _{CE} = 5.0 Vdc) (I _C = 3.0 Adc, V _{CE} = 5.0 Vdc) (I _C = 5.0 Adc, V _{CE} = 5.0 Vdc) (I _C = 8.0 Adc, V _{CE} = 5.0 Vdc) (I _C = 15 Adc, V _{CE} = 5.0 Vdc)	h _{FE}	80 80 80 80 50 10	250 250 250 250 – –	–
Collector–Emitter Saturation Voltage (I _C = 8.0 Adc, I _B = 0.8 Adc)	V _{CE(sat)}	–	1.0	Vdc
Emitter–Base Saturation Voltage (I _C = 8.0 Adc, I _B = 0.8 A)	V _{BE(sat)}	–	1.4	Vdc
Base–Emitter ON Voltage (I _C = 8.0 Adc, V _{CE} = 5.0 Vdc)	V _{BE(on)}	–	1.5	Vdc
DYNAMIC CHARACTERISTICS				
Current–Gain – Bandwidth Product (I _C = 1.0 Adc, V _{CE} = 5.0 Vdc, f _{test} = 1.0 MHz)	f _T	35	–	MHz
Output Capacitance (V _{CB} = 10 Vdc, I _E = 0, f _{test} = 1.0 MHz)	C _{ob}	–	600	pF

MJL4281A (NPN) MJL4302A (PNP)

TYPICAL CHARACTERISTICS

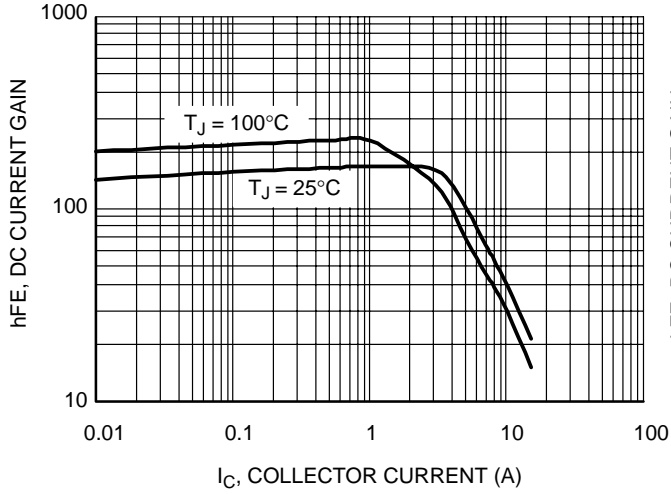

Figure 1. DC Current Gain, $V_{CE} = 5\text{ V}$, NPN MJL4281A

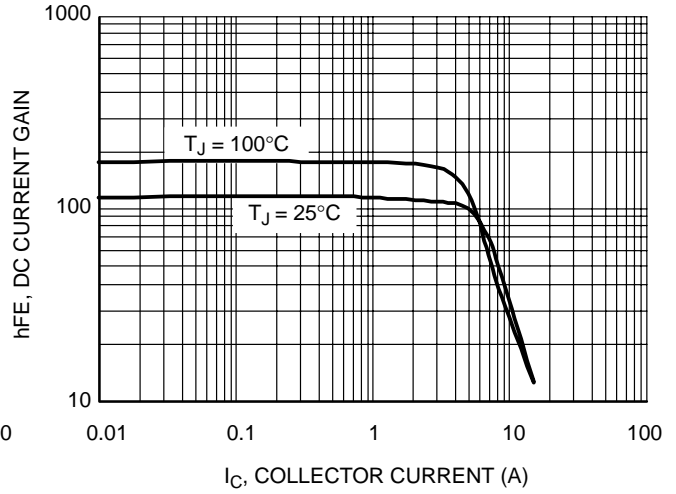

Figure 2. DC Current Gain, $V_{CE} = 5\text{ V}$, PNP MJL4302A

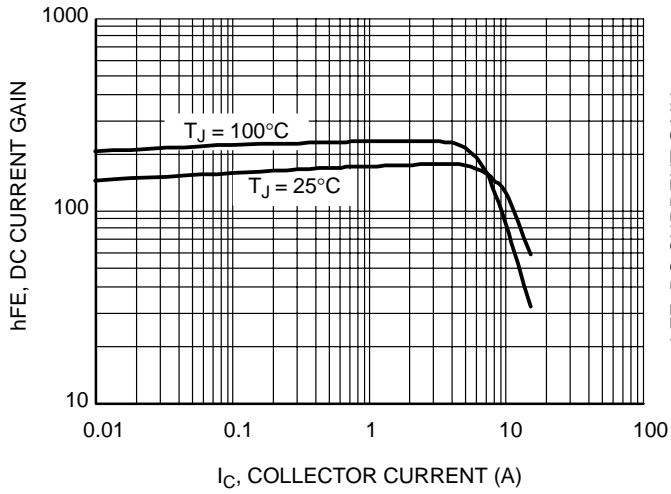

Figure 3. DC Current Gain, $V_{CE} = 20\text{ V}$, NPN MJL4281A

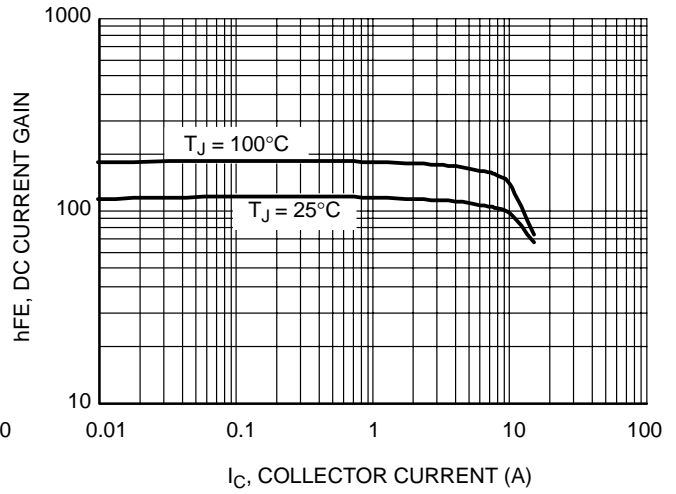

Figure 4. DC Current Gain, $V_{CE} = 20\text{ V}$, PNP MJL4302A

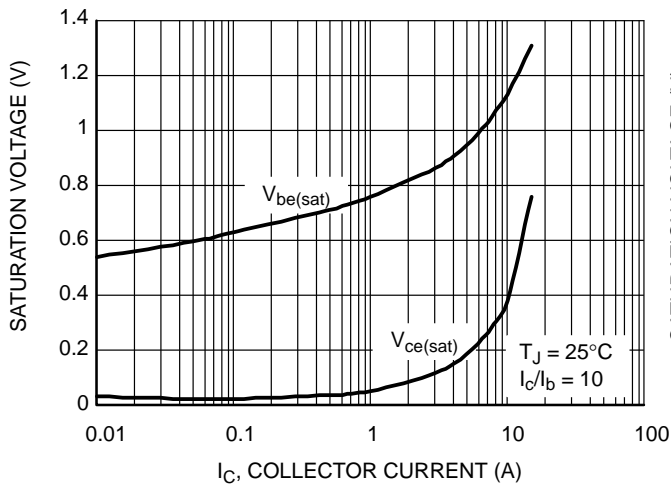

Figure 5. Typical Saturation Voltage, NPN MJL4281A

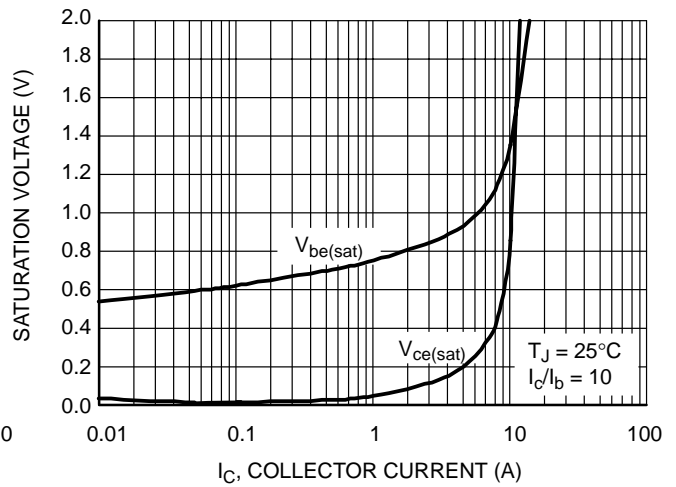

Figure 6. Typical Saturation Voltage, PNP MJL4302A

MJL4281A (NPN) MJL4302A (PNP)

TYPICAL CHARACTERISTICS

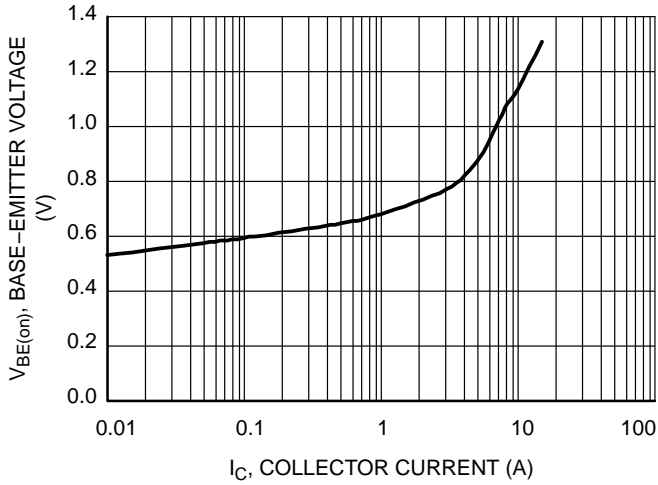

Figure 7. Typical Base-Emitter Voltages, NPN MJL4281A

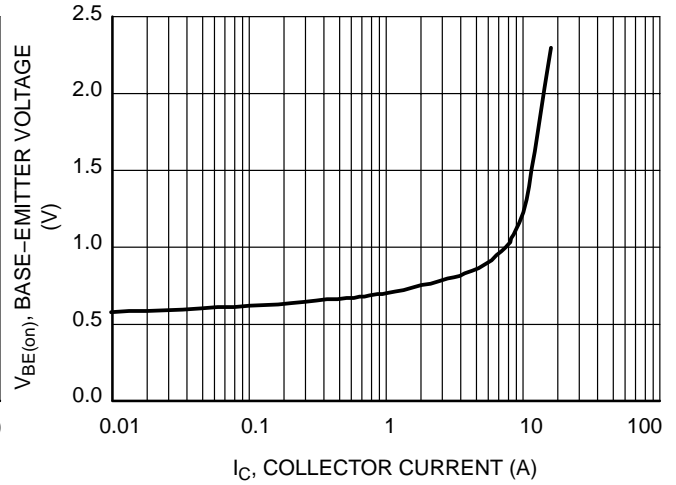

Figure 8. Typical Base-Emitter Voltages, PNP MJL4302A

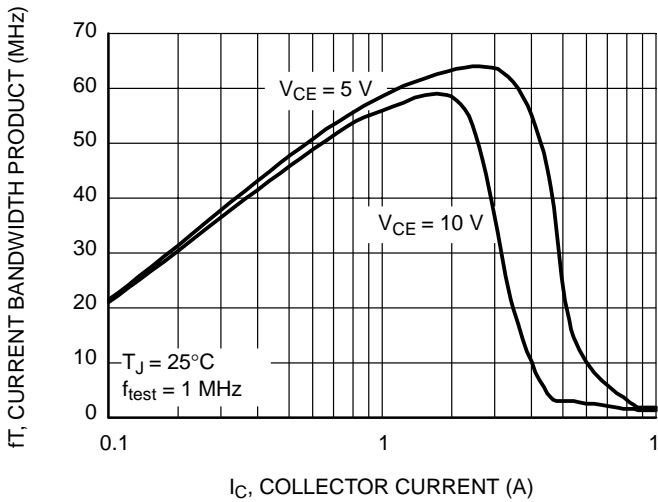

Figure 9. Typical Current Gain Bandwidth Product, NPN MJL4281A

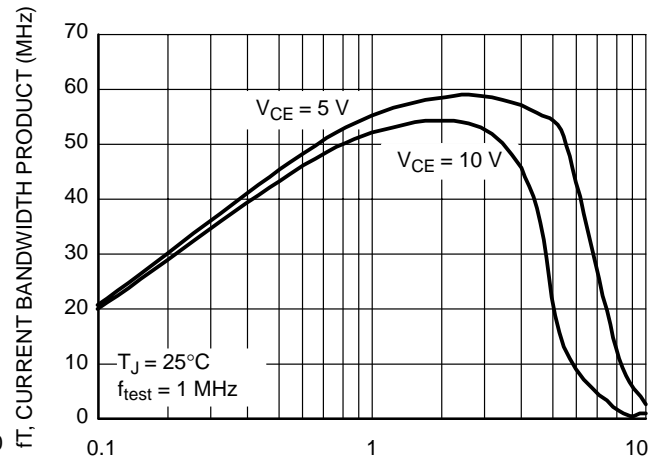

Figure 10. Typical Current Gain Bandwidth Product, PNP MJL4302A

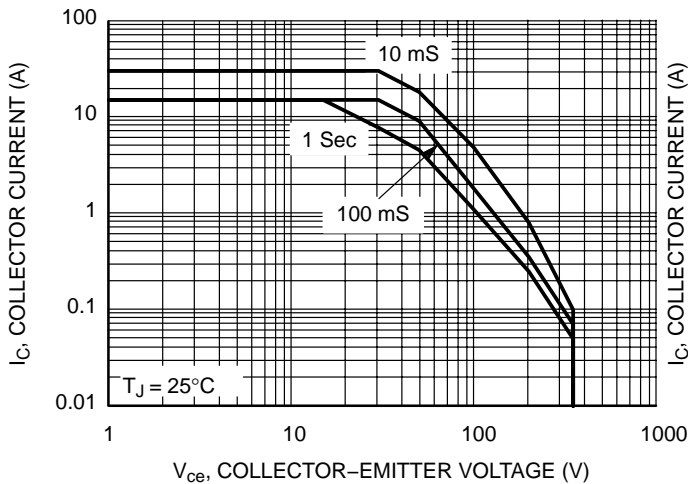

Figure 11. Active Region Safe Operating Area, NPN MJL4281A

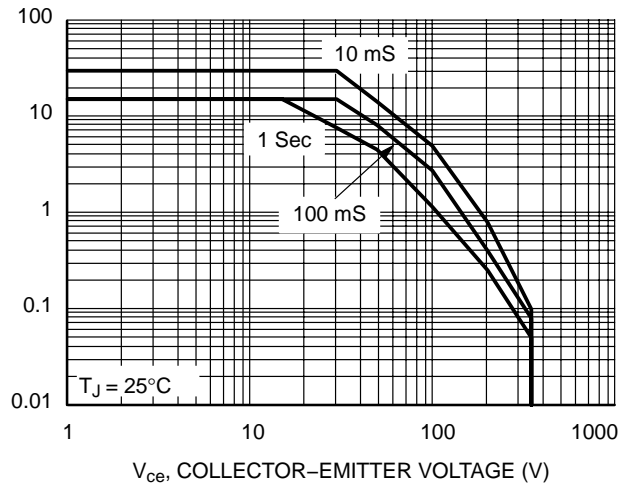
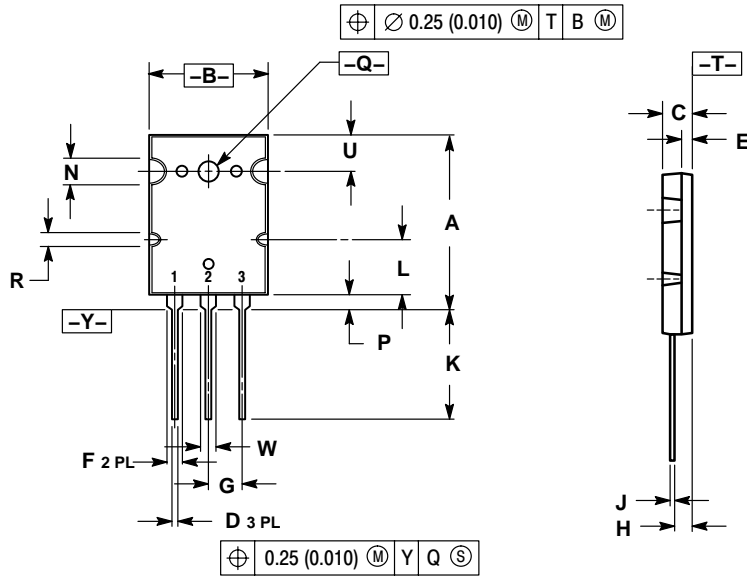

Figure 12. Active Region Safe Operating Area, PNP MJL4302A

MJL4281A (NPN) MJL4302A (PNP)

PACKAGE DIMENSIONS

TO-3PBL (TO-264)
CASE 340G-02
ISSUE H



- NOTES:
1. DIMENSIONING AND TOLERANCING PER ANSI Y14.5M, 1982.
2. CONTROLLING DIMENSION: MILLIMETER.

DIM	MILLIMETERS		INCHES	
	MIN	MAX	MIN	MAX
A	28.0	29.0	1.102	1.142
B	19.3	20.3	0.760	0.800
C	4.7	5.3	0.185	0.209
D	0.93	1.48	0.037	0.058
E	1.9	2.1	0.075	0.083
F	2.2	2.4	0.087	0.102
G	5.45 BSC		0.215 BSC	
H	2.6	3.0	0.102	0.118
J	0.43	0.78	0.017	0.031
K	17.6	18.8	0.693	0.740
L	11.0	11.4	0.433	0.449
N	3.95	4.75	0.156	0.187
P	2.2	2.6	0.087	0.102
Q	3.1	3.5	0.122	0.137
R	2.15	2.35	0.085	0.093
U	6.1	6.5	0.240	0.256
W	2.8	3.2	0.110	0.125

- STYLE 2:
PIN 1. BASE
2. COLLECTOR
3. EMITTER

MJL4281A (NPN) MJL4302A (PNP)

PowerBase is a trademark of Semiconductor Components Industries, LLC.

ON Semiconductor and  are registered trademarks of Semiconductor Components Industries, LLC (SCILLC). SCILLC reserves the right to make changes without further notice to any products herein. SCILLC makes no warranty, representation or guarantee regarding the suitability of its products for any particular purpose, nor does SCILLC assume any liability arising out of the application or use of any product or circuit, and specifically disclaims any and all liability, including without limitation special, consequential or incidental damages. "Typical" parameters which may be provided in SCILLC data sheets and/or specifications can and do vary in different applications and actual performance may vary over time. All operating parameters, including "Typicals" must be validated for each customer application by customer's technical experts. SCILLC does not convey any license under its patent rights nor the rights of others. SCILLC products are not designed, intended, or authorized for use as components in systems intended for surgical implant into the body, or other applications intended to support or sustain life, or for any other application in which the failure of the SCILLC product could create a situation where personal injury or death may occur. Should Buyer purchase or use SCILLC products for any such unintended or unauthorized application, Buyer shall indemnify and hold SCILLC and its officers, employees, subsidiaries, affiliates, and distributors harmless against all claims, costs, damages, and expenses, and reasonable attorney fees arising out of, directly or indirectly, any claim of personal injury or death associated with such unintended or unauthorized use, even if such claim alleges that SCILLC was negligent regarding the design or manufacture of the part. SCILLC is an Equal Opportunity/Affirmative Action Employer.

PUBLICATION ORDERING INFORMATION

Literature Fulfillment:

Literature Distribution Center for ON Semiconductor
P.O. Box 5163, Denver, Colorado 80217 USA
Phone: 303-675-2175 or 800-344-3860 Toll Free USA/Canada
Fax: 303-675-2176 or 800-344-3867 Toll Free USA/Canada
Email: orderlit@onsemi.com

N. American Technical Support: 800-282-9855 Toll Free USA/Canada

JAPAN: ON Semiconductor, Japan Customer Focus Center
2-9-1 Kamimeguro, Meguro-ku, Tokyo, Japan 153-0051
Phone: 81-3-5773-3850

ON Semiconductor Website: <http://onsemi.com>

For additional information, please contact your local Sales Representative.