

# B3F

轻触式开关

6mm方形、12mm方形  
具有横向操作、高负载、  
镀金型等全系列产品

- 实现轻快的接触感及高寿命
- 备有可用于通用的径向带状部件插入机的带状规格
- 备有可以在长时间内保持稳定接触和绝缘的镀金型。
- 可安装键顶(B32系列)，有凸型柱塞。

符合RoHS

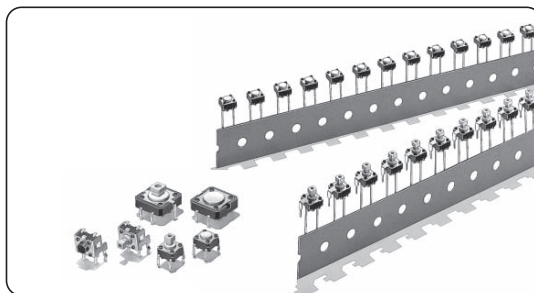

B  
3  
F

## ■ 种类

### 6mm方形

型号	柱塞的种类	高度	动作力	接地端子 包装形态 柱塞颜色	无	有
					袋装 (100个/袋)	
6mm方形 标准型 (B3F-1000系列)	(平型)	4.3mm	0.98N	象牙色	B3F-1000	B3F-1100
			1.47N	黄	B3F-1002	B3F-1102
			2.55N	橙	B3F-1005	B3F-1105
			4.9N	红	B3F-1006	—
		5.0mm	0.98N	黑	B3F-1020	B3F-1120
			1.47N	灰	B3F-1022	B3F-1122
	2.55N		粉红	B3F-1025	B3F-1125	
	5.0mm (7.5mm节距)	4.9N	蓝	B3F-1026	—	
	(凸型)	7.0mm	0.98N	黑	B3F-1060	—
			1.47N	黄	B3F-1062	—
			0.98N	黑	B3F-1070	—
		9.5mm	1.47N	黄	B3F-1072	—
			2.55N	橙	B3F-1075	—
			0.98N	象牙色	B3F-1050	B3F-1150
		7.3mm	1.47N	黄	B3F-1052	B3F-1152
2.55N			橙	B3F-1055	B3F-1155	
4.9N			红	B3F-1056	—	
6mm方形 横向操作型 (B3F-3000系列)	(平型)	3.15mm	0.98N	象牙色	—	B3F-3100
			1.47N	黄	—	B3F-3102
			2.55N	橙	—	B3F-3105
	(凸型)	3.85mm	0.98N	黑	—	B3F-3120
			1.47N	灰	—	B3F-3122
			2.55N	粉红	—	B3F-3125
	(平型)	6.15mm	0.98N	象牙色	—	B3F-3150
			1.47N	黄	—	B3F-3152
			2.55N	橙	—	B3F-3155
6mm方形 镀金型 (B3F-G系列)	(平型)	4.3mm	黄	B3F-1002-G	B3F-1102-G	
		5.0mm	灰	B3F-1022-G	B3F-1122-G	
		7.0mm	黄	B3F-1062-G	—	
		9.5mm	黄	B3F-1072-G	—	
	(凸型)	7.3mm	1.76N	黄	B3F-1052-G	—
	(平型)	3.85mm	灰	—	B3F-3122-G	

注. 订购数量必须为100个的整数倍。

# B3F

# 轻触式开关

## 12mm方形

型号	柱塞的种类	高度	动作力	柱塞颜色	接地端子	
					无	有
12mm方形 标准型 (B3F-4000系列)	平型	4.3mm	1.27N	象牙色	B3F-4000	B3F-4100
			2.55N	黄	B3F-4005	B3F-4105
	凸型	7.3mm	1.27N	象牙色	B3F-4050	B3F-4150
			2.55N	黄	B3F-4055	B3F-4155
12mm方形 长寿型 (B3F-5000系列)	平型	4.3mm	1.27N	蓝	B3F-5000	B3F-5100
	凸型	7.3mm		蓝	B3F-5050	B3F-5150
12mm方形 高信赖型 (B3F-5001系列)	平型	4.3mm	1.27N	蓝	B3F-5001	B3F-5101
	凸型	7.3mm		蓝	B3F-5051	B3F-5151

注.订购数量必须为100个的整数倍。

## 6mm方形柱塞型(压花带装规格)

型号	柱塞的种类	高度	动作力	柱塞颜色	接地端子	
					无	有
柱塞型 (B3F-6000系列)	平型	4.3mm	0.98N	象牙色	B3F-6000	B3F-6100
			1.47N	黄	B3F-6002	B3F-6102
		5.0mm	0.98N	黑	B3F-6020	B3F-6120
			1.47N	灰	B3F-6022	B3F-6122
	凸型	7.3mm	0.98N	象牙色	B3F-6050	B3F-6150
			1.47N	黄	B3F-6052	B3F-6152

注.订购数量必须为1,000个的整数倍。注意不可以端子数发货。

## ■额定值/性能

电气规格	DC5~24V 1~50mA 阻性负载 (B3F-G系列: DC5~24V 100μA~50mA)
使用环境温度	-25~+70℃, 60%RH以下(无结冰、无凝露)
使用环境湿度	35~85%RH (+5~+35℃)
接点结构	1a常开接点
接触电阻	100mΩ以下(初始值)(DC5V 1mA通电)(B3F-G系列: DC5V 100μA通电)
绝缘电阻	100MΩ以上(DC250V兆欧表)
耐电压	AC500V 50/60Hz 1min
震荡时间	5ms以下
振动	误动作 频率10~55Hz 双振幅1.5mm
冲击	耐久 最大1,000m/s <sup>2</sup>
	误动作 最大100m/s <sup>2</sup>
寿命	B3F-1000系列、B3F-3000系列、B3F-6000系列 100万次以上(OE:0.98N型、B3F-1070在50万次以上) 30万次以上(OE:1.47N型) 10万次以上(OE:2.55N型) 5万次以上(OE:4.9N型) B3F-4000系列 300万次以上(OE:1.27N型) 100万次以上(OE:2.55N型) B3F-5000系列: 1000万次以上 B3F-G系列: 30万次以上
重量	6mm方形: 约0.25g、12mm方形: 约0.85g(标准数值)、开孔形: 约0.25g

## ■动作特性

项目	类型 动作力(OF) 型号	B3F-1000、-3000、-6000系列				B3F-4000、-5000系列		B3F-G系列
		0.98N型	1.47N型	2.55N型	4.9N型	1.27N型	2.55N型	1.76N型
动作力(OF)	B3F-1□□0 B3F-3□□0 B3F-6□□0	B3F-1□□2 B3F-3□□2 B3F-6□□2	B3F-1□□5 B3F-3□□5	B3F-10□□6	B3F-4□□0 B3F-5□□0	B3F-4□□5	B3F-1□□2-G B3F-3□□2-G	
动作力(OF)		0.98±0.29N	1.47±0.49N	2.55±0.69N	4.9±1.47N	1.27±0.49N	2.55±0.69N	1.76±0.49N
回复力(RF)		最小0.2N	最小0.49N	最小0.49N	最小0.7N	最小0.29N	最小0.49N	最小0.49N
过行程(PT)		0.25 <sup>+0.1</sup> mm				0.3 <sup>+0.1</sup> mm		0.25 <sup>+0.1</sup> mm

OMRON

A-181

# B3F

## 轻触式开关

### ■外形尺寸 (单位:mm)

6mm方形

注: BOTTOM VIEW 中“OMRON”的标识在正常状态下(见右图), 端子编号如右图。  
(横压型和径向型除外)



#### ●标准型、平型 (无接地端子)

B3F-1000 B3F-1002 B3F-1005 B3F-1006  
B3F-1020\* B3F-1022\* B3F-1025\* B3F-1026\*  
B3F-1002-G  
B3F-1022-G\*

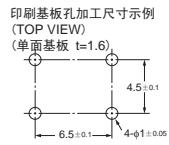
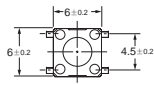

端子配置/内部连接图  
(TOP VIEW)

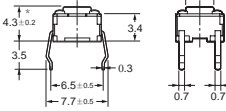
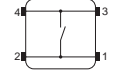

\* B3F-1020、B3F-1022、B3F-1025、B3F-1026、B3F-1022-G高度在5±0.2mm

#### ●标准型、平型 (有接地端子、间距6.5mm)

B3F-1100 B3F-1102 B3F-1105  
B3F-1120\* B3F-1122\* B3F-1125\*  
B3F-1102-G  
B3F-1122-G\*

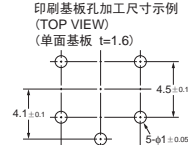
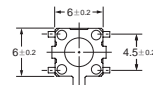

端子配置/内部连接图  
(TOP VIEW)

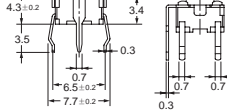
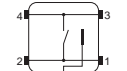

\* B3F-1120、B3F-1122、B3F-1125、B3F-1122-G高度在5±0.2mm

#### ●标准型、平型 (有接地端子、间距7.5mm)

B3F-1110

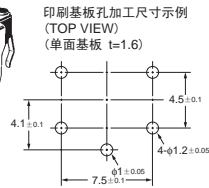
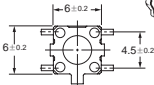

端子配置/内部连接图  
(TOP VIEW)

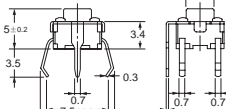

#### ●标准型、平型 (无接地端子)

B3F-1060 B3F-1062 B3F-1062-G

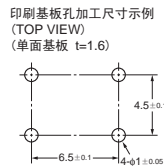
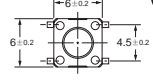

端子配置/内部连接图  
(TOP VIEW)

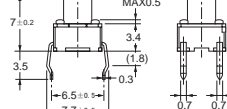
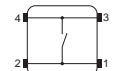

#### ●标准型、平型 (无接地端子)

B3F-1070 B3F-1072 B3F-1075 B3F-1072-G

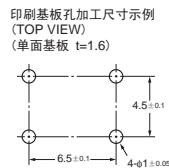
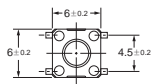

端子配置/内部连接图  
(TOP VIEW)

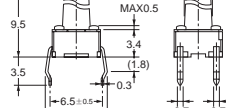
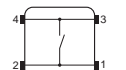

#### ●标准型、凸型 (无接地端子)

B3F-1050 B3F-1052  
B3F-1055 B3F-1056  
B3F-1052-G

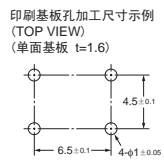
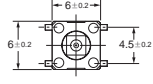

端子配置/内部连接图  
(TOP VIEW)

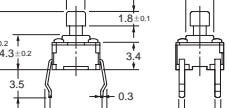

注: 上述外形尺寸图中, 未注公差为±0.4mm。开关本体上没有标明端子编号。

# B3F

# 轻触式开关

## ●标准型、凸型（有接地端子）

B3F-1150 B3F-1152 B3F-1155

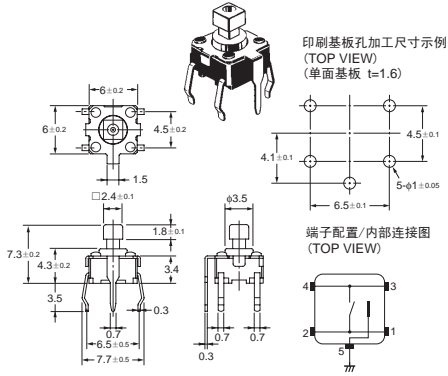

## ●横向操作型、平型

B3F-3100 B3F-3102 B3F-3105

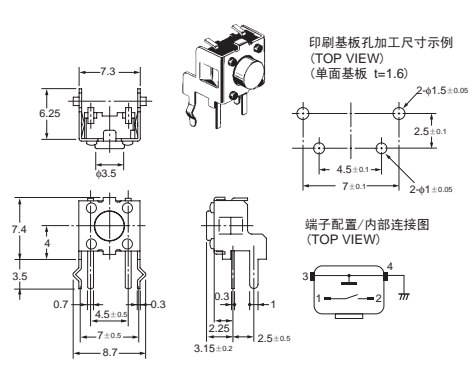

## ●横向操作型、平型(高度3.85m)

B3F-3120 B3F-3122 B3F-3125  
B3F-3122-G

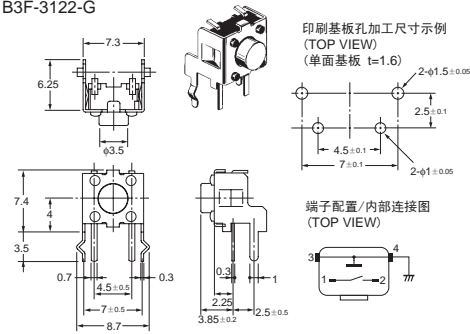

## ●横向操作型、凸型

B3F-3150 B3F-3152 B3F-3155

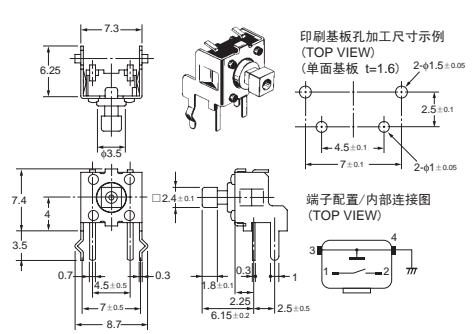

注. 上述外形尺寸图中, 未注公差为±0.4mm. 开关本体上没有标明端子编号.

B  
3  
F

# B3F

# 轻触式开关

## 12mm方形

- 标准型、长寿命型、高信赖型  
平型（无接地端子）  
B3F-4000 B3F-4005  
B3F-5000 B3F-5001

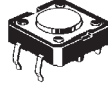

印刷基板孔加工尺寸示例  
(TOP VIEW)  
(单面基板 t=1.6)

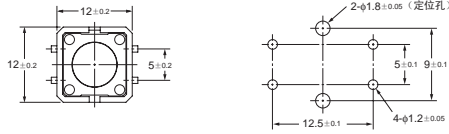

端子配置/内部连接图  
(TOP VIEW)

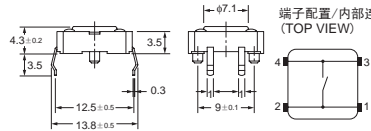

- 标准型、长寿命型、高信赖型  
平型（有接地端子）  
B3F-4100 B3F-4105  
B3F-5100 B3F-5101

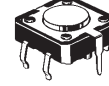

印刷基板孔加工尺寸示例  
(TOP VIEW)  
(单面基板 t=1.6)

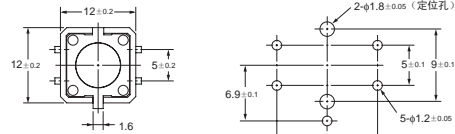

端子配置/内部连接图  
(TOP VIEW)

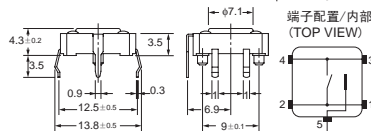

- 标准型、长寿命型、高信赖型  
凸型（无接地端子）  
B3F-4050 B3F-4055  
B3F-5050 B3F-5051

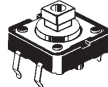

印刷基板孔加工尺寸示例  
(TOP VIEW)  
(单面基板 t=1.6)

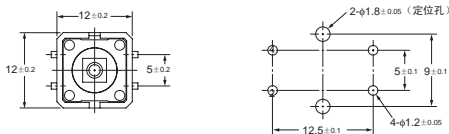

端子配置/内部连接图  
(TOP VIEW)

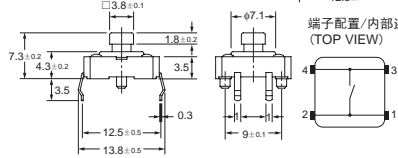

- 标准型、长寿命型、高信赖型  
凸型（有接地端子）  
B3F-4150 B3F-4155  
B3F-5150 B3F-5151

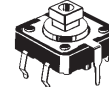

印刷基板孔加工尺寸示例  
(TOP VIEW)  
(单面基板 t=1.6)

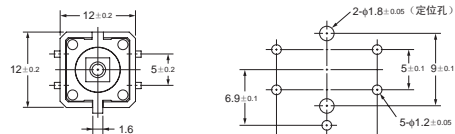

端子配置/内部连接图  
(TOP VIEW)

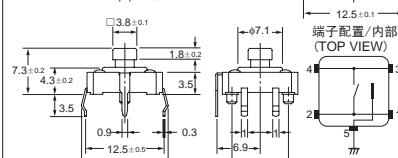

注. 上述外形尺寸图中, 未注公差为±0.4mm.

# B3F

# 轻触式开关

6mm方形柱塞型 (袋装规格)

注. BOTTOM VIEW 中“OMRON”的标识在正常状态下(见右图), 端子编号如右图。



●平型(无接地端子)  
B3F-6000  
B3F-6002

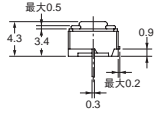
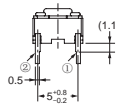
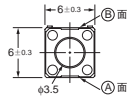
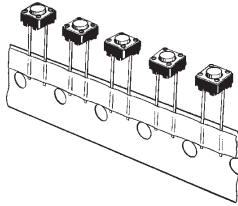

印刷基板孔加工尺寸示例  
(TOP VIEW)  
(单面基板t=1.6)

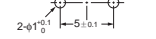

端子配置/内部连接图  
(TOP VIEW)

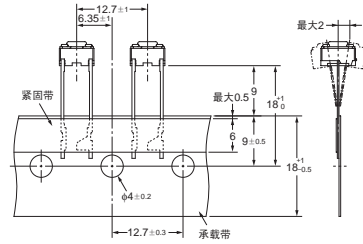

注. 带子的方向随机为㉑面或㉒面

●平型(有接地端子)  
B3F-6100  
B3F-6102

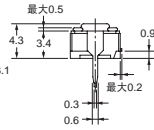
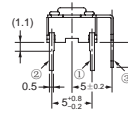
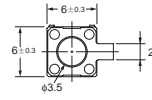
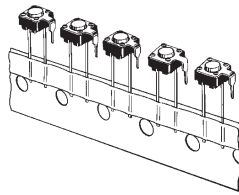

印刷基板孔加工尺寸示例  
(TOP VIEW)  
(单面基板t=1.6)

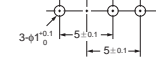

端子配置/内部连接图  
(TOP VIEW)

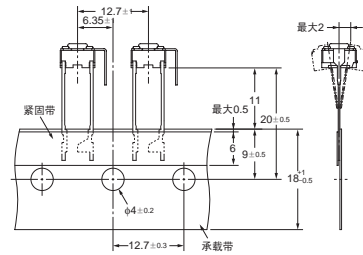

●平型(无接地端子)  
B3F-6020  
B3F-6022

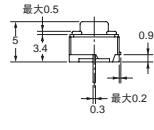
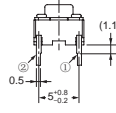
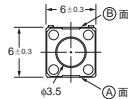
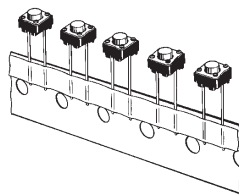

印刷基板孔加工尺寸示例  
(TOP VIEW)  
(单面基板t=1.6)

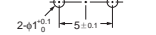

端子配置/内部连接图  
(TOP VIEW)

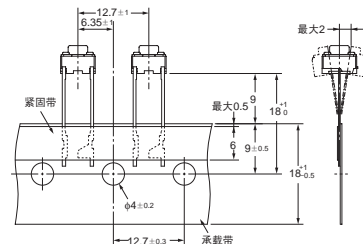

注. 带子的方向随机为㉑面或㉒面

注. 上述的各种机型外型尺寸, 未注公差为±0.4mm. 开关本体上没有标明端子编号。

# B3F

# 轻触式开关

●平型(有接地端子)  
B3F-6120  
B3F-6122

B  
3  
F

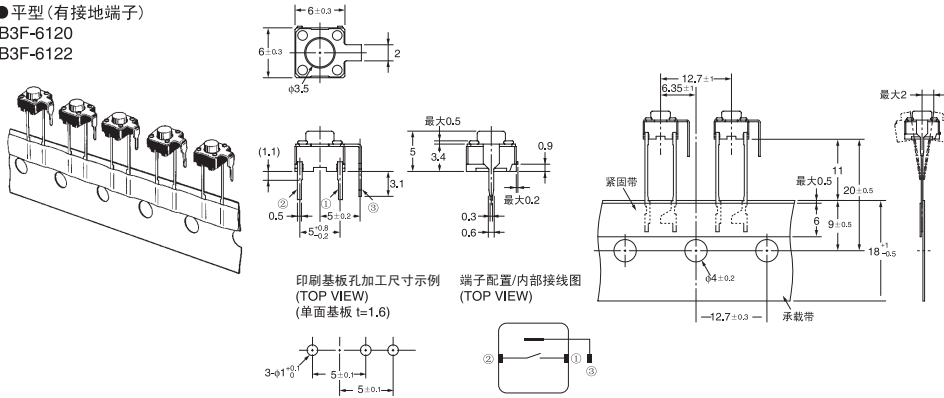

●凸型(无接地端子)  
B3F-6050  
B3F-6052

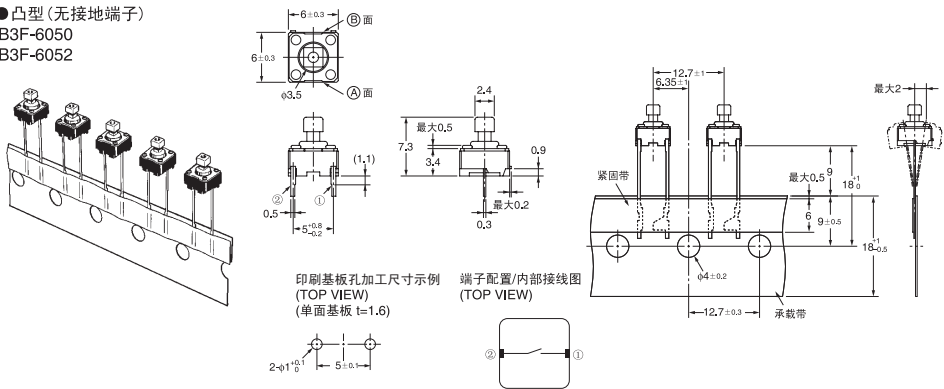

注. 带子的方向随机为①面或②面

●凸型(有接地端子)  
B3F-6150  
B3F-6152

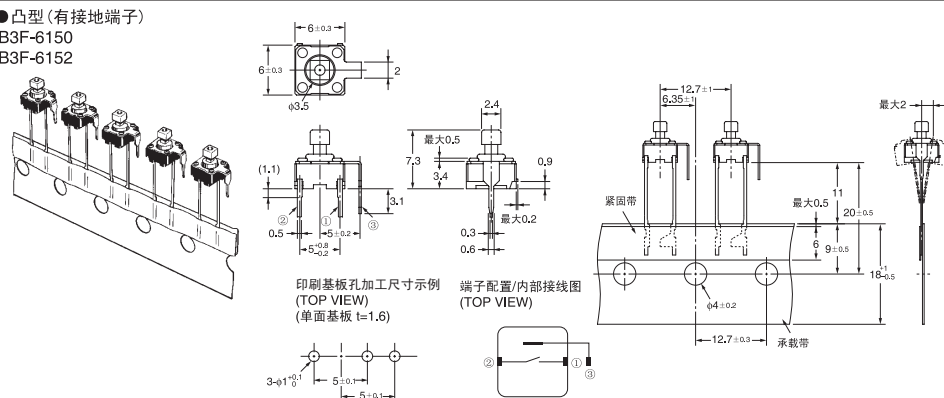

注. 上述的各种机型外型尺寸, 未注公差为±0.4mm. 开关本体上没有标明端子编号。

## ■键顶

凸柱基型, 备有专用的键顶及B32型系列详细内容请参见有关章节。

## ■请正确使用

★「共通注意事项」请参考相关页。