

# SRPH1 Series

## Single phase, Analog input type SSR

NEW

### Features

- Power control/ Cycle control/Phase control (fixed cycle/ variable cycle) are available with 4-20mA analog input
- Superior dielectric strength : 4,000VAC
- Improved reliability by maximizing heat protection efficiency with heatsink integrated design and ceramic board
- Various mounting methods (DIN rail, panel front)
- Checks input status by Input LED(green)



⚠ Please read "Caution for your safety" in operation manual before using.



### Ordering information

SRP H 1 - A 2 30

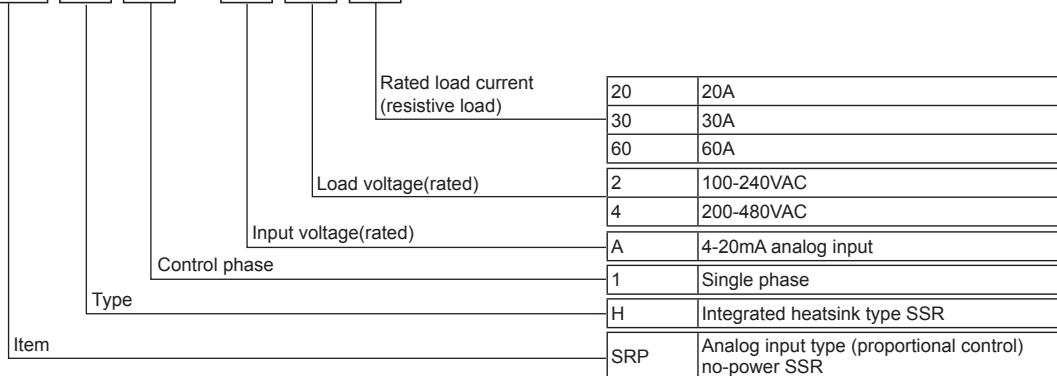

Model	Rated load current	Load voltage
SRPH1-A220	20A	100-240VAC
SRPH1-A230	30A	
SRPH1-A260	60A	

Model	Rated load current	Load voltage
SRPH1-A420	20A	200-480VAC
SRPH1-A430	30A	
SRPH1-A460	60A	

### Specifications

#### Input

4-20mA analog input	
Max. allowable input current	50mA
Pick-up current	4.2mA
Static off current	0.2mA
Power factor	Min. 0.9 (max. 25° of difference between voltage phase and current phase)
Input LED	Green
Start-up time	60Hz: 200ms, 50Hz: 250ms
Operation time	60Hz: 16.6ms, 50Hz:20ms
Operation mode*1	Cycle control(fixed cycle, variable cycle) Phase control(phase equality division type, power equality division type)

\*1: You can change operation mode by jumper pin. Default is Phase control(Power equality division type).

# Analog Input Type SSR

## Specifications

### Output

100-240VAC load voltage			
Load voltage range(50/60Hz)		90-264VACrms(50/60Hz)	
Rated load current Ta=25°C	Resistive load (AC-51)	20Arms	30Arms
			60Arms
Min. load current		0.5Arms	
Max. 1 cycle surge current (60Hz)		300A	500A
			1000A
Max. non-repetitive surge current(I <sup>2</sup> t, t=8.3ms)		350A <sup>2</sup> S	1000A <sup>2</sup> S
			4000A <sup>2</sup> S
Peak voltage(Non-repetitive)		600V	
Leakage current (240VAC/60Hz, Ta=25°C)		Max. 10mArms	
Output ON voltage drop[Vpk] (max. load current)		Max. 1.6V	
Static off state dv/dt		500V/μs	
200-480VAC load voltage			
Load voltage range(50/60Hz)		200-528VACrms	
Rated load current Ta=25°C	Resistive load (AC-51)	20Arms	30Arms
	Motor load (AC-53a)	5Arms	8Arms
			15Arms
Min. load current		0.5Arms	
Max. 1 cycle surge current (60Hz)		300A	500A
			1000A
Max. non-repetitive surge current(I <sup>2</sup> t, t=8.3ms)		350A <sup>2</sup> S	1000A <sup>2</sup> S
			4000A <sup>2</sup> S
Peak voltage(non-repetitive)		1000V	
Leakage current (480VAC/60Hz, Ta=25°C)		Max. 10mArms	
Output ON voltage drop [Vpk](Max. load current)		Max. 1.6V	
Static off state dv/dt		500V/μs	

### General Specifications

Certification	UL508, CSA22.2, No.14, IEC/EN 60947-4-3		
Phase control (phase equality division type)	5 to 99%		
Phase control (power equality division type)	10 to 99%		
Frequency reading function	Yes		
Dielectric strength(Vrms)	4000VAC 50/60Hz for 1min. (Input-Output, Input/Output-Case)		
Insulation resistance	Min. 100MΩ(at 500VDC megger)		
Vibration	10 to 55Hz double amplitude 0.75mm in each of X, Y, Z directions for 1 hour		
Environ-ment	Ambient temperature	-20 to 70°C, storage : -20 to 100°C (The rated load current capacity is different depending on ambient temperature. Refer to '■ SSR Derating curve'.)	
	Ambient humidity	45 to 85%RH	
Input terminal connection	Min. 1×0.5mm <sup>2</sup> (1×AWG20) Max. 1×1.5mm <sup>2</sup> (1×AWG6) or Max. 2×1.5mm <sup>2</sup> (2×AWG16)		
Output terminal connection	Min. 1×1.5mm <sup>2</sup> (1×AWG16) Max.1×16mm <sup>2</sup> (1×AWG6) or Max. 2×6mm <sup>2</sup> (2×AWG10) ※Connect appropriate cable for the load current capacity to output terminal.		
Input terminal fixed torque	0.75 to 0.95N·m		
Output terminal fixed torque	1.6 to 2.2N·m		
Unit weight	• SRPH1-A220, SRPH1-A230, SRPH1-A420, SRPH1-A430 : Approx. 410g • SRPH1-A260, SRPH1-A460 : Approx. 680g		

※For wiring the terminal, an O-ring terminal must be used.

※Environment resistance is rated at no freezing or condensation.

(A)	Photo electric sensor
(B)	Fiber optic sensor
(C)	Door/Area sensor
(D)	Proximity sensor
(E)	Pressure sensor
(F)	Rotary encoder
(G)	Connector/Socket
(H)	Temp. controller
(I)	SSR/ Power controller
(J)	Counter
(K)	Timer
(L)	Panel meter
(M)	Tacho/ Speed/ Pulse meter
(N)	Display unit
(O)	Sensor controller
(P)	Switching mode power supply
(Q)	Stepper motor& Driver&Controller
(R)	Graphic/ Logic panel
(S)	Field network device
(T)	Software
(U)	Other

# SRPH1 Series

## Dimensions & Mounting

(unit: mm)

### Dimensions

#### 20A/30A rated load current

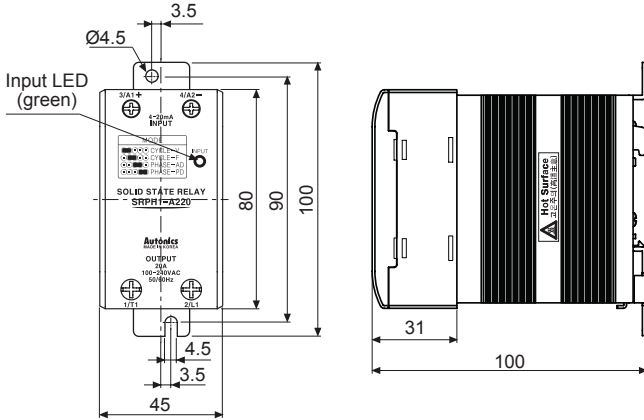

#### 60A rated load current

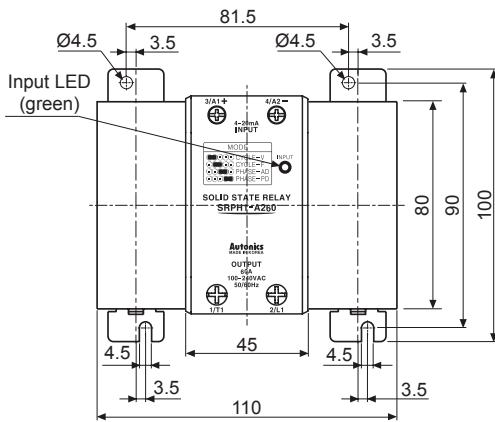

### Hole cut-out for panel front mounting

#### 20A/30A rated load current

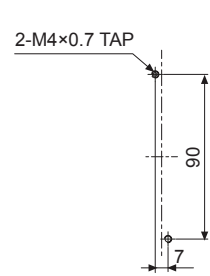

#### 60A rated load current

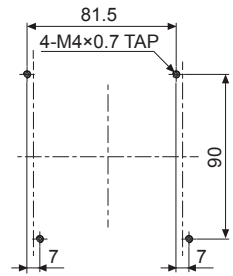

※Tightening torque for mounting: 1.8 to 2.5N·m

### DIN rail mounting

#### DIN rail attachment

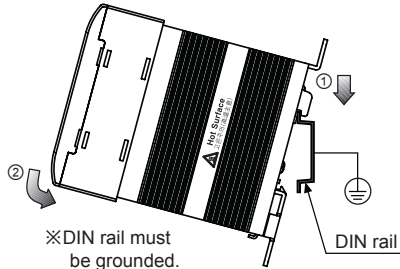

#### DIN rail detachment

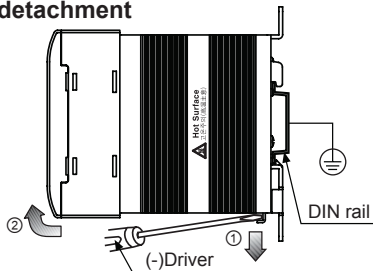

### Installation interval

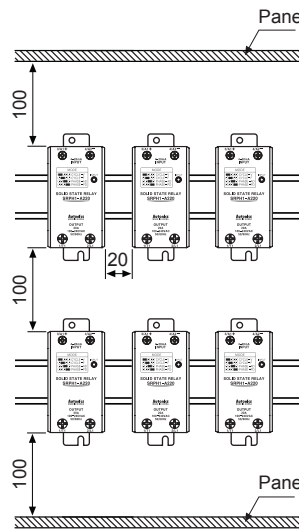

※For mounting multiple SSR, please keep certain installation intervals for heat prevention.  
For horizontal installation (when the heights of input part and output part are equal), it is recommended to apply 50% of rated load current.

**High temperature caution**  
Make sure do not touch the heat sink or the unit body while power is supplied or right after load power is turned off.  
If not, it may cause a burn.

# Analog Input Type SSR

## Connections

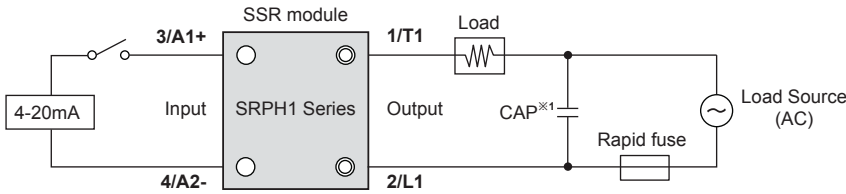

※1: As above connection, connect a capacitor. It is proper to EMC.

CAP: Load voltage 100-240VAC → 1uF/250VAC, Load voltage 200-480VAC → 0.47uF/500VAC

## SSR Characteristic curve

○ SRPH1-A220/A420

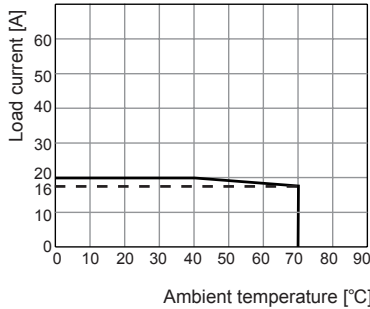

○ SRPH1-A230/A430

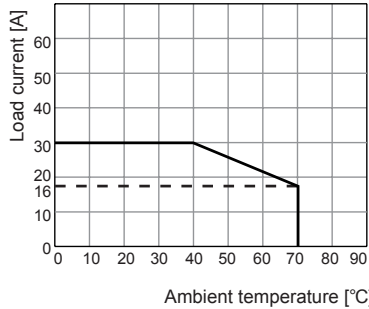

○ SRPH1-A260/A460

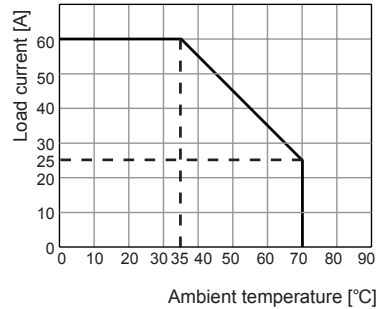

## Operation setting

### Detach front cover

Press front cover connection 4 parts at right and left side with (-) driver, and front cover is detached.

※Before detaching front cover, you must cut off load current and input.

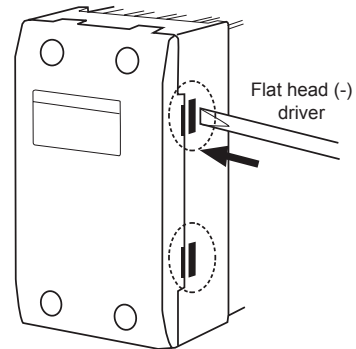

### Jumper pin setting

Operation mode is decided by jumper position.

After changing operation mode, re-supply input signal.

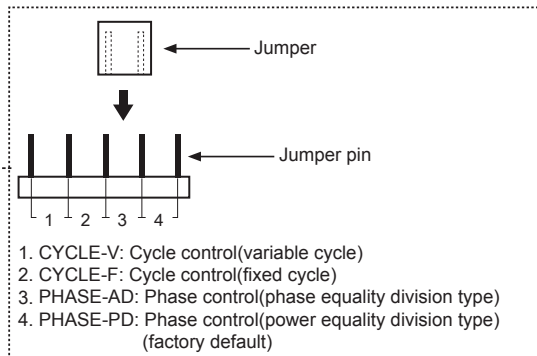
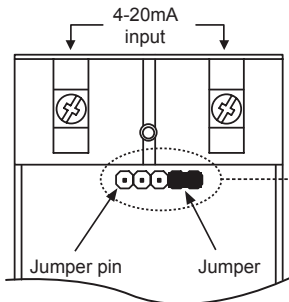

- (A) Photo electric sensor
- (B) Fiber optic sensor
- (C) Door/Area sensor
- (D) Proximity sensor
- (E) Pressure sensor
- (F) Rotary encoder
- (G) Connector/ Socket
- (H) Temp. controller
- (I) SSR/ Power controller
- (J) Counter
- (K) Timer
- (L) Panel meter
- (M) Tacho/ Speed/ Pulse meter
- (N) Display unit
- (O) Sensor controller
- (P) Switching mode power supply
- (Q) Stepper motor& Driver&Controller
- (R) Graphic/ Logic panel
- (S) Field network device
- (T) Software
- (U) Other

# SRPH1 Series

## ■ Operation mode

### ○ Phase control

#### ● Output waveform of phase control

- When control input signal is 25%
- When control input signal is 50%
- When control input signal is 75%

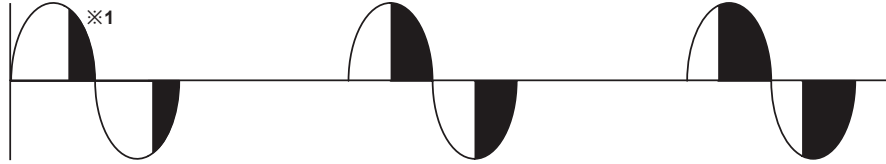

※1: The black parts of output waveform are output on the load.

#### ● Power equality division type

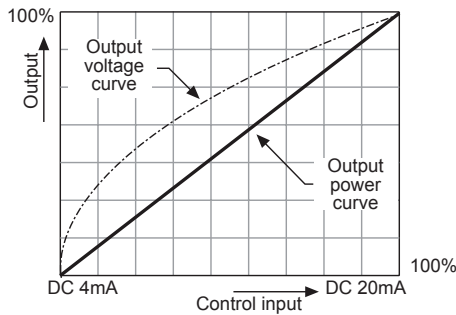

Controls output power which is proportional to control input(4-20mA) level.

#### ● Phase equality division type

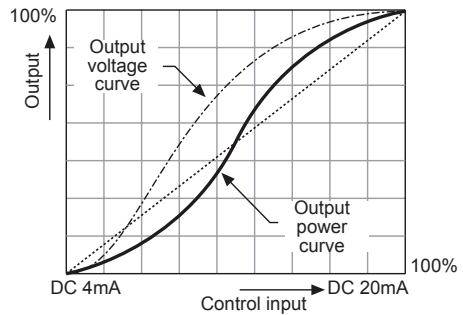

Controls phase angle which is proportional control input(4-20mA) level.

### ○ Cycle control

#### ● Fixed cycle

Controls continuously the number of full cycle which is supplied to load every 1sec. by being proportional to control input (4-20mA).

- When control input signal is 0%

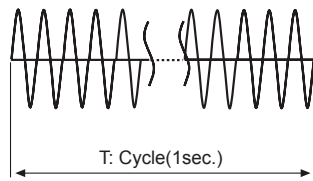

- When control input signal is 50%

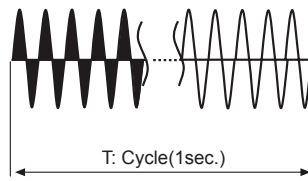

- When control input signal is 100%

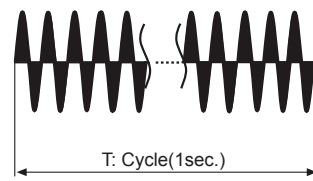

#### ● Variable cycle

Controls fast and accurately the subject with optimized the number of AC voltage cycle which is supplied to load by being proportional to control input (4-20mA).

- When control input signal is 10%

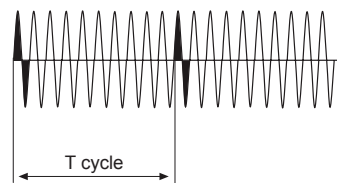

- When control input signal is 50%

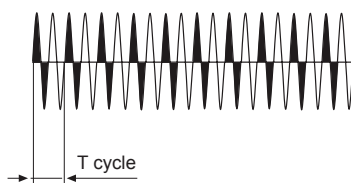

- When control input signal is 90%

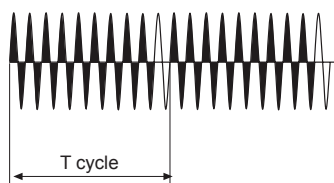

# Analog Input Type SSR

## ■ Proper usage

### ⚠ High temperature caution

Make sure do not touch the heat sink or the unit body while power is supplied or right after load power is turned off. If not, it may cause a burn.

### ⚠ Caution for using

1. Attach a heatsink and ventilate for smooth convection current. If not, congested heat transfer may cause product failure or malfunction.
2. For mounting multiple SSR, please keep certain installation intervals for heat prevention. For horizontal installation (when the heights of input part and output part are equal), it is recommended to apply less than 50% of the rated load current.
3. Make sure do not touch the heatsink or the unit body while power is supplied or right after load power is turned OFF. If not, it may cause a burn.
4. Connect the proper cable for the rated load current with output terminal.
5. Use rapid fuse of which  $I^2t$  is under 1/2 of SSR  $I^2t$  in order to protect the unit from load's short-circuit current.
6. In case of a short-circuit please replace the fuse with a 1/2 of SSR  $I^2t$  value specified semiconductor protective type.
7. In case that load's current is lower than SSR min. load current, connect dummy resistance to the load in parallel so as to make load's current higher than SSR min. load current.
8. Make sure that the screw on output terminal is tightly fastened. Using the unit with loose bolt may cause product failure or malfunction.
9. Do not touch the load's terminal even if output is OFF. It may cause electric shock.
10. The input of the 4-20mA should be supplied by the insulated and limited voltage/current or by class 2 power supply.
11. Proper application environment (Avoid following environments to install)
  - ① Where temperature/humidity is beyond the specification
  - ② Where dew condensation occurs due to temperature change
  - ③ Where inflammable or corrosive gas exists
  - ④ Where direct rays of light exist
  - ⑤ Where severe shock, vibration or dust exists
  - ⑥ Where near facilities generating strong magnetic forces or electric noise
12. Installation environment
  - ① It shall be used indoor
  - ② Altitude Max. 2,000m
  - ③ Pollution Degree 2
  - ④ Installation Category III

(A)	Photo electric sensor
(B)	Fiber optic sensor
(C)	Door/Area sensor
(D)	Proximity sensor
(E)	Pressure sensor
(F)	Rotary encoder
(G)	Connector/Socket
(H)	Temp. controller
(I)	SSR/Power controller
(J)	Counter
(K)	Timer
(L)	Panel meter
(M)	Tacho/Speed/ Pulse meter
(N)	Display unit
(O)	Sensor controller
(P)	Switching mode power supply
(Q)	Stepper motor& Driver&Controller
(R)	Graphic/ Logic panel
(S)	Field network device
(T)	Software
(U)	Other