

FQPF8N60C

N-Channel QFET® MOSFET

600 V, 7.5 A, 1.2 Ω

Description

These N-Channel enhancement mode power field effect transistors are produced using Fairchild's proprietary, planar stripe, DMOS technology. This advanced technology has been especially tailored to minimize on-state resistance, provide superior switching performance, and withstand high energy pulse in the avalanche and commutation mode. These devices are well suited for high efficiency switched mode power supplies, active power factor correction, electronic lamp ballasts based on half bridge topology.

Features

- 7.5 A, 600 V, $R_{DS(on)} = 1.2 \Omega$ (Max.) @ $V_{GS} = 10 V$, $I_D = 3.75 A$
- Low Gate Charge (Typ. 28 nC)
- Low C_{rss} (Typ. 12 pF)
- 100% Avalanche Tested

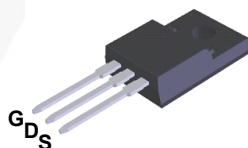

TO-220F

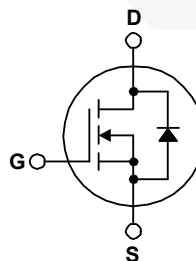

Absolute Maximum Ratings $T_C = 25^\circ C$ unless otherwise noted.

Symbol	Parameter	FQPF8N60C	Unit
V_{DSS}	Drain-Source Voltage	600	V
I_D	Drain Current - Continuous ($T_C = 25^\circ C$) - Continuous ($T_C = 100^\circ C$)	7.5 *	A
		4.6 *	A
I_{DM}	Drain Current - Pulsed (Note 1)	30 *	A
V_{GSS}	Gate-Source Voltage	± 30	V
E_{AS}	Single Pulsed Avalanche Energy (Note 2)	230	mJ
I_{AR}	Avalanche Current (Note 1)	7.5	A
E_{AR}	Repetitive Avalanche Energy (Note 1)	14.7	mJ
dv/dt	Peak Diode Recovery dv/dt (Note 3)	4.5	V/ns
P_D	Power Dissipation ($T_C = 25^\circ C$) - Derate above $25^\circ C$	48	W
		0.38	W/ $^\circ C$
T_J, T_{STG}	Operating and Storage Temperature Range	-55 to +150	$^\circ C$
T_L	Maximum lead temperature for soldering purposes, 1/8" from case for 5 seconds	300	$^\circ C$

* Drain current limited by maximum junction temperature.

Thermal Characteristics

Symbol	Parameter	FQPF8N60C	Unit
$R_{\theta JC}$	Thermal Resistance, Junction-to-Case, Max.	2.6	$^\circ C/W$
$R_{\theta JA}$	Thermal Resistance, Junction-to-Ambient, Max.	62.5	$^\circ C/W$

Package Marking and Ordering Information

Part Number	Top Mark	Package	Packing Method	Reel Size	Tape Width	Quantity
FQPF8N60C	FQPF8N60C	TO-220F	Tube	N/A	N/A	50 units

Electrical Characteristics T_c = 25°C unless otherwise noted.

Symbol	Parameter	Test Conditions	Min	Typ	Max	Unit
Off Characteristics						
BV _{DSS}	Drain-Source Breakdown Voltage	V _{GS} = 0 V, I _D = 250 μA	600	--	--	V
ΔBV _{DSS} / ΔT _J	Breakdown Voltage Temperature Coefficient	I _D = 250 μA, Referenced to 25°C	--	0.7	--	V/°C
I _{DSS}	Zero Gate Voltage Drain Current	V _{DS} = 600 V, V _{GS} = 0 V	--	--	1	μA
		V _{DS} = 480 V, T _C = 125°C	--	--	10	μA
I _{GSSF}	Gate-Body Leakage Current, Forward	V _{GS} = 30 V, V _{DS} = 0 V	--	--	100	nA
I _{GSSR}	Gate-Body Leakage Current, Reverse	V _{GS} = -30 V, V _{DS} = 0 V	--	--	-100	nA

On Characteristics

V _{GS(th)}	Gate Threshold Voltage	V _{DS} = V _{GS} , I _D = 250 μA	2.0	--	4.0	V
R _{DS(on)}	Static Drain-Source On-Resistance	V _{GS} = 10 V, I _D = 3.75 A	--	1.0	1.2	Ω
g _{FS}	Forward Transconductance	V _{DS} = 40 V, I _D = 3.75 A	--	8.7	--	S

Dynamic Characteristics

C _{iss}	Input Capacitance	V _{DS} = 25 V, V _{GS} = 0 V, f = 1.0 MHz	--	965	1255	pF
C _{oss}	Output Capacitance		--	105	135	pF
C _{rss}	Reverse Transfer Capacitance		--	12	16	pF

Switching Characteristics

t _{d(on)}	Turn-On Delay Time	V _{DD} = 300 V, I _D = 7.5 A, R _G = 25 Ω	--	16.5	45	ns
t _r	Turn-On Rise Time		--	60.5	130	ns
t _{d(off)}	Turn-Off Delay Time		--	81	170	ns
t _f	Turn-Off Fall Time		(Note 4)	--	64.5	140
Q _g	Total Gate Charge	V _{DS} = 480 V, I _D = 7.5 A, V _{GS} = 10 V	--	28	36	nC
Q _{gs}	Gate-Source Charge		--	4.5	--	nC
Q _{gd}	Gate-Drain Charge		(Note 4)	--	12	--

Drain-Source Diode Characteristics and Maximum Ratings

I _S	Maximum Continuous Drain-Source Diode Forward Current	--	--	7.5	A	
I _{SM}	Maximum Pulsed Drain-Source Diode Forward Current	--	--	30	A	
V _{SD}	Drain-Source Diode Forward Voltage	V _{GS} = 0 V, I _S = 7.5 A	--	--	1.4	V
t _{rr}	Reverse Recovery Time	V _{GS} = 0 V, I _S = 7.5 A,	--	365	--	ns
Q _{rr}	Reverse Recovery Charge	di _F / dt = 100 A/μs	--	3.4	--	μC

Notes:

1. Repetitive rating : pulse-width limited by maximum junction temperature.
2. L = 7.3 mH, I_{AS} = 7.5 A, V_{DD} = 50 V, R_G = 25 Ω, starting T_J = 25°C.
3. I_{SD} ≤ 7.5 A, di/dt ≤ 200 A/μs, V_{DD} ≤ BV_{DSS}, starting T_J = 25°C.
4. Essentially independent of operating temperature.

Typical Characteristics

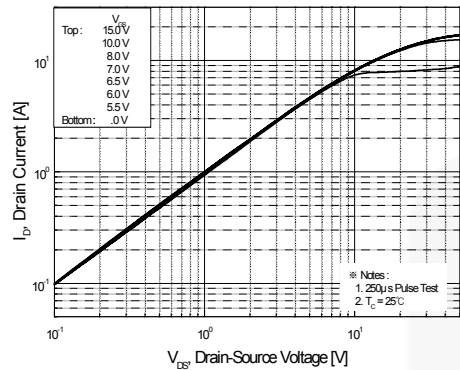

Figure 1. On-Region Characteristics

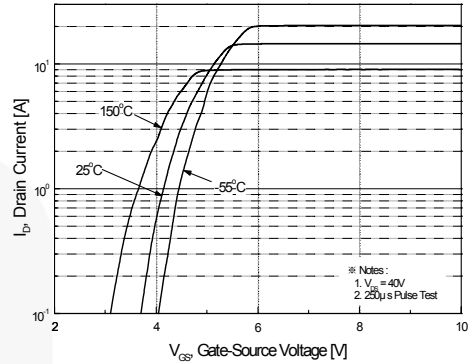

Figure 2. Transfer Characteristics

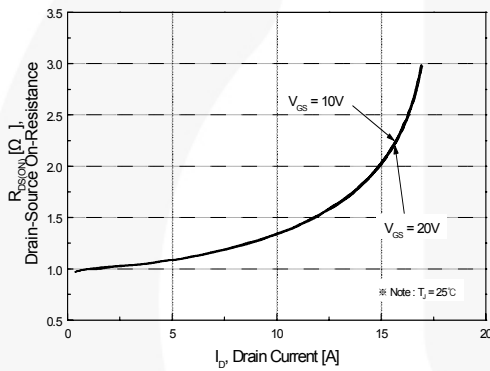

Figure 3. On-Resistance Variation vs. Drain Current and Gate Voltage

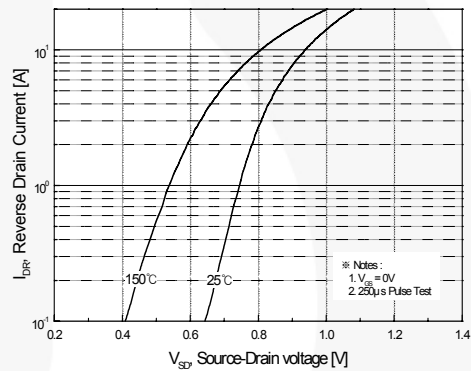

Figure 4. Body Diode Forward Voltage Variation with Source Current and Temperature

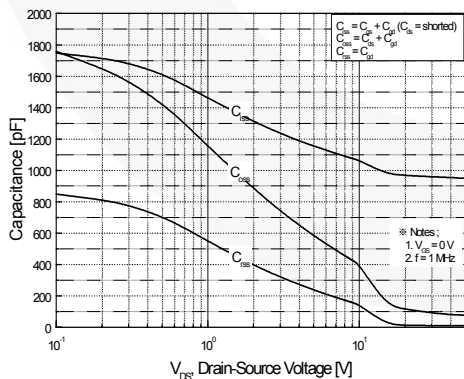

Figure 5. Capacitance Characteristics

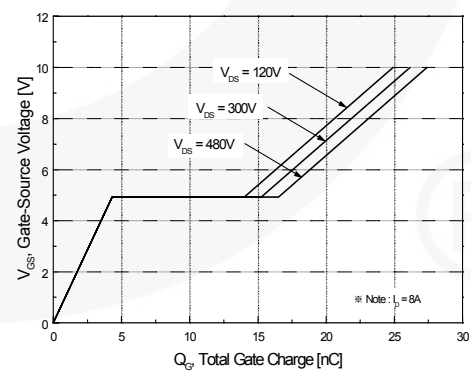

Figure 6. Gate Charge Characteristics

Typical Characteristics (continued)

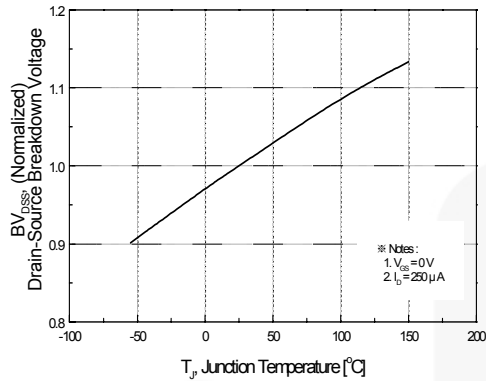

Figure 7. Breakdown Voltage Variation vs Temperature

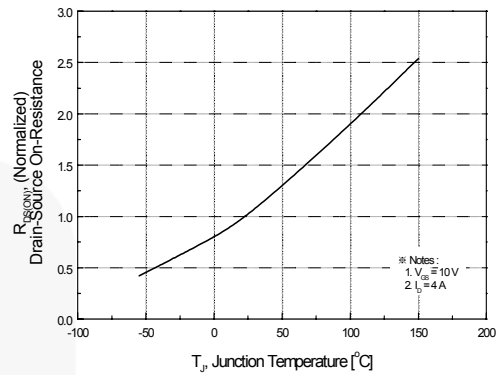

Figure 8. On-Resistance Variation vs Temperature

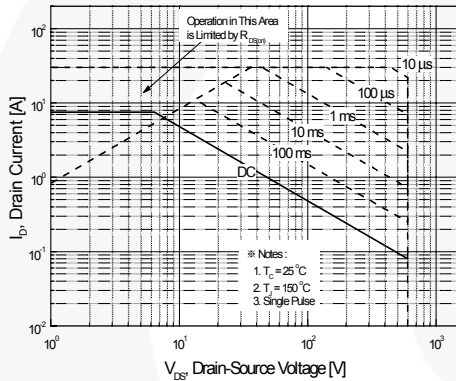

Figure 9. Maximum Safe Operating Area

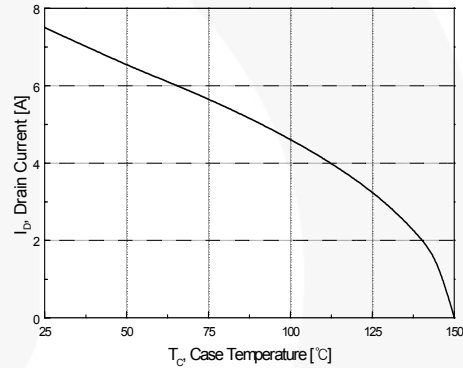

Figure 10. Maximum Drain Current vs Case Temperature

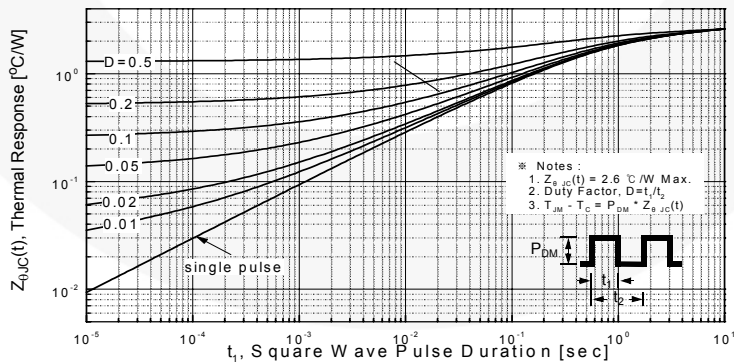

Figure 11. Transient Thermal Response Curve

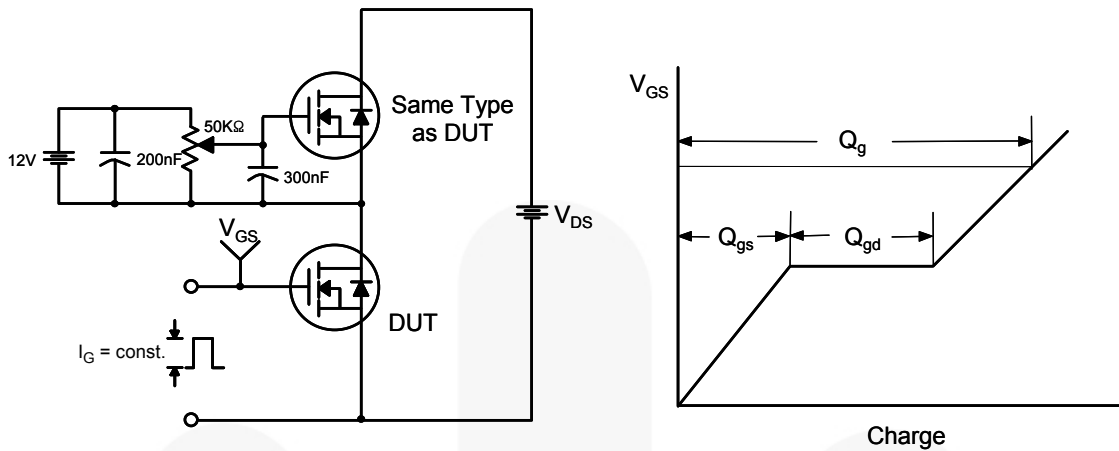

Figure 12. Gate Charge Test Circuit & Waveform

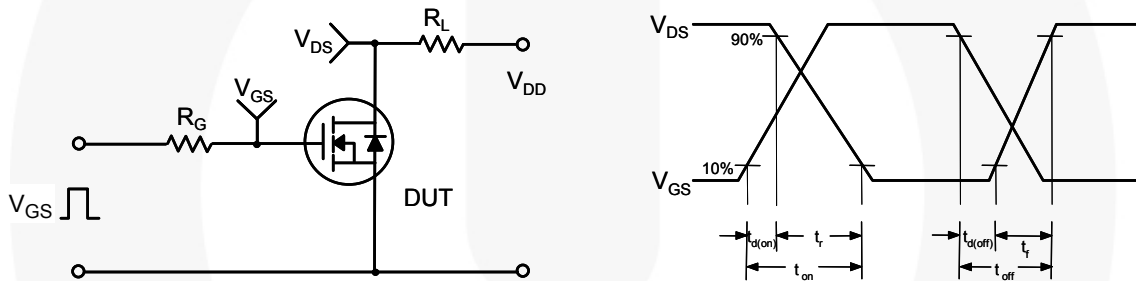

Figure 13. Resistive Switching Test Circuit & Waveforms

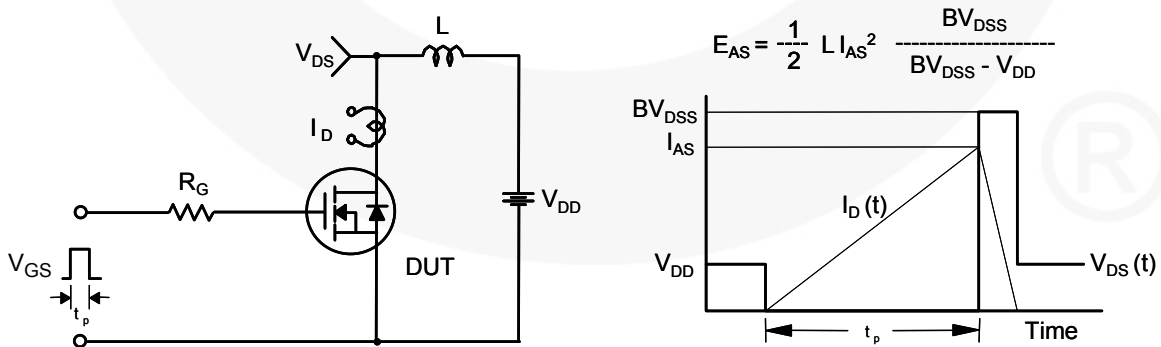

Figure 14. Unclamped Inductive Switching Test Circuit & Waveforms

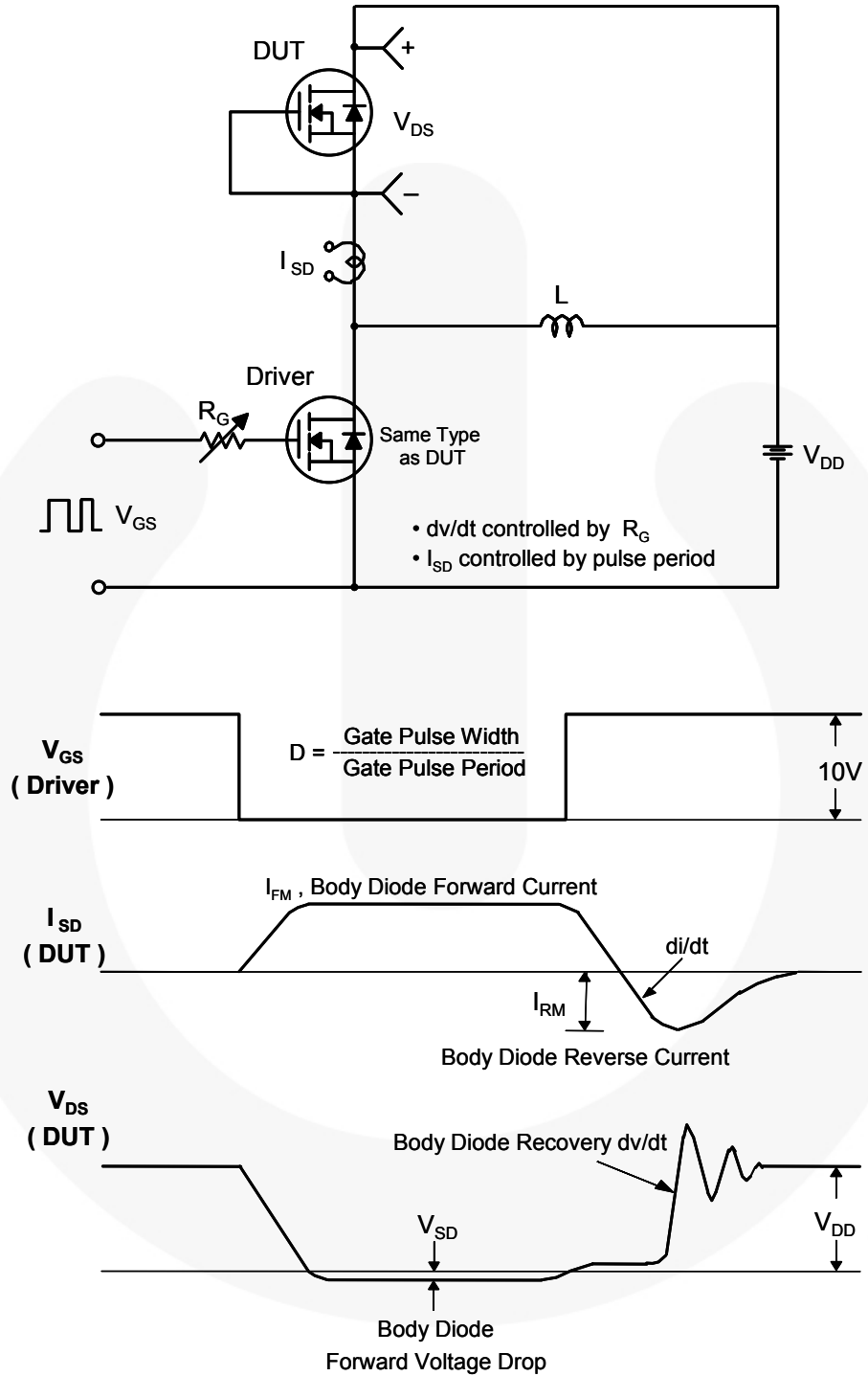





Figure 15. Peak Diode Recovery dv/dt Test Circuit & Waveforms



TRADEMARKS

The following includes registered and unregistered trademarks and service marks, owned by Fairchild Semiconductor and/or its global subsidiaries, and is not intended to be an exhaustive list of all such trademarks.

- | | | | |
|--|---|---|---|
| AccuPower™ | F-PFS™ | PowerTrench® | Sync-Lock™ |
| AX-CAP®* | FRFET® | PowerXS™ | SYSTEM GENERAL®* |
| BitSiC™ | Global Power Resource SM | Programmable Active Droop™ | TinyBoost® |
| Build it Now™ | GreenBridge™ | QFET® | TinyBuck® |
| CorePLUS™ | Green FPS™ | QS™ | TinyCalc™ |
| CorePOWER™ | Green FPS™ e-Series™ | Quiet Series™ | TinyLogic® |
| CROSSVOLT™ | Gmax™ | RapidConfigure™ | TINYOPTO™ |
| CTL™ | GTO™ | | TinyPower™ |
| Current Transfer Logic™ | IntelliMAX™ |  Saving our world, 1mW/W/kW at a time™ | TinyPWM™ |
| DEUXPEED® | ISOPLANAR™ | SignalWise™ | TinyWire™ |
| Dual Cool™ | Marking Small Speakers Sound Louder and Better™ | SmartMax™ | TranSiC™ |
| EcoSPARK® | MegaBuck™ | SMART START™ | TriFault Detect™ |
| EfficientMax™ | MICROCOUPLER™ | Solutions for Your Success™ | TRUECURRENT®* |
| ESBC™ | MicroFET™ | SPM® | µSerDes™ |
|  Fairchild® | MicroPak™ | STEALTH™ |  SerDes® |
| Fairchild Semiconductor® | MicroPak2™ | SuperFET® | UHC® |
| FACT Quiet Series™ | MillerDrive™ | SuperSOT™-3 | Ultra FRFET™ |
| FACT® | MotionMax™ | SuperSOT™-6 | UniFET™ |
| FAST® | mWSaver® | SuperSOT™-8 | VCX™ |
| FastvCore™ | OptoHiT™ | SupreMOS® | VisualMax™ |
| FETBench™ | OPTOLOGIC® | SyncFET™ | VoltagePlus™ |
| FPS™ | OPTOPLANAR® | | XS™ |

*Trademarks of System General Corporation, used under license by Fairchild Semiconductor.

DISCLAIMER

FAIRCHILD SEMICONDUCTOR RESERVES THE RIGHT TO MAKE CHANGES WITHOUT FURTHER NOTICE TO ANY PRODUCTS HEREIN TO IMPROVE RELIABILITY, FUNCTION, OR DESIGN. FAIRCHILD DOES NOT ASSUME ANY LIABILITY ARISING OUT OF THE APPLICATION OR USE OF ANY PRODUCT OR CIRCUIT DESCRIBED HEREIN; NEITHER DOES IT CONVEY ANY LICENSE UNDER ITS PATENT RIGHTS, NOR THE RIGHTS OF OTHERS. THESE SPECIFICATIONS DO NOT EXPAND THE TERMS OF FAIRCHILD'S WORLDWIDE TERMS AND CONDITIONS, SPECIFICALLY THE WARRANTY THEREIN, WHICH COVERS THESE PRODUCTS.

LIFE SUPPORT POLICY

FAIRCHILD'S PRODUCTS ARE NOT AUTHORIZED FOR USE AS CRITICAL COMPONENTS IN LIFE SUPPORT DEVICES OR SYSTEMS WITHOUT THE EXPRESS WRITTEN APPROVAL OF FAIRCHILD SEMICONDUCTOR CORPORATION.

As used here in:

- Life support devices or systems are devices or systems which, (a) are intended for surgical implant into the body or (b) support or sustain life, and (c) whose failure to perform when properly used in accordance with instructions for use provided in the labeling, can be reasonably expected to result in a significant injury of the user.
- A critical component in any component of a life support, device, or system whose failure to perform can be reasonably expected to cause the failure of the life support device or system, or to affect its safety or effectiveness.

ANTI-COUNTERFEITING POLICY

Fairchild Semiconductor Corporation's Anti-Counterfeiting Policy. Fairchild's Anti-Counterfeiting Policy is also stated on our external website, www.Fairchildsemi.com, under Sales Support. Counterfeiting of semiconductor parts is a growing problem in the industry. All manufactures of semiconductor products are experiencing counterfeiting of their parts. Customers who inadvertently purchase counterfeit parts experience many problems such as loss of brand reputation, substandard performance, failed application, and increased cost of production and manufacturing delays. Fairchild is taking strong measures to protect ourselves and our customers from the proliferation of counterfeit parts. Fairchild strongly encourages customers to purchase Fairchild parts either directly from Fairchild or from Authorized Fairchild Distributors who are listed by country on our web page cited above. Products customers buy either from Fairchild directly or from Authorized Fairchild Distributors are genuine parts, have full traceability, meet Fairchild's quality standards for handling and storage and provide access to Fairchild's full range of up-to-date technical and product information. Fairchild and our Authorized Distributors will stand behind all warranties and will appropriately address and warranty issues that may arise. Fairchild will not provide any warranty coverage or other assistance for parts bought from Unauthorized Sources. Fairchild is committed to combat this global problem and encourage our customers to do their part in stopping this practice by buying direct or from authorized distributors.

PRODUCT STATUS DEFINITIONS

Definition of Terms

Datasheet Identification	Product Status	Definition
Advance Information	Formative / In Design	Datasheet contains the design specifications for product development. Specifications may change in any manner without notice.
Preliminary	First Production	Datasheet contains preliminary data; supplementary data will be published at a later date. Fairchild Semiconductor reserves the right to make changes at any time without notice to improve design.
No Identification Needed	Full Production	Datasheet contains final specifications. Fairchild Semiconductor reserves the right to make changes at any time without notice to improve the design.
Obsolete	Not In Production	Datasheet contains specifications on a product that is discontinued by Fairchild Semiconductor. The datasheet is for reference information only.

Rev. I66