

3500 series

High performance toggle switches - environmentally sealed

Distinctive features and specifications

UG1006-A

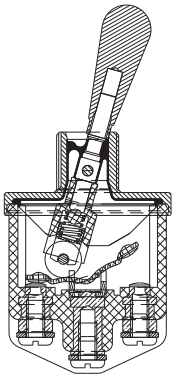

- Completely sealed switches withstanding 0,1 bar pressure**
 - Frontal sealing to IP67 or IP69K by a silicone membrane (for sealed panel mounting, add washer U60, section I).
 - Rear sealing to IP 64 provided by moulded-in terminal inserts
- Approved to European standards CECC 96000**
- Three types of terminals**
- Many lever styles available**

ELECTRICAL SPECIFICATIONS

- Max. current/voltage rating with resistive load and electrical life at full load: see table below
- Initial contact resistance : 10 mΩ max. at 1A 2VDC
- Insulation resistance : 1.000 MΩ
- Dielectric strength : 2.500 Vrms 50 Hz min. between terminals
3.000 Vrms 50 Hz min. between terminals and frame

GENERAL PERFORMANCES

FUNCTIONS	GENERAL PERFORMANCES		According to CECC 96201-004
	Alternate current	Direct Current	
ON-OFF and ON-ON	6.000 cycles, T65°C 20A 125VAC, 3/4HP 15A 250VAC, 1-1/2HP T5, 115VAC, 50/400Hz	10.000 cycles, T20°C 15A 28VDC resistive 15A 28VDC inductive 5A 28VDC lamp load	10.000 cycles 16A 250VAC 15A 32VDC
ON OFF ON	6.000 cycles, T65°C 18A 125VAC, 1/2HP 10A 250VAC, 1/2HP T2, 115VAC, 50/400Hz	10.000 cycles, T20°C 15A 28VDC resistive 15A 28VDC inductive 5A 28VDC lamp load	
OTHER FUNCTIONS	6.000 cycles, T65°C 15A 125VAC 10A 250VAC T2, 115VAC, 50/400Hz	10.000 cycles, T20°C 15A 28VDC resistive 10A 28VDC inductive 3A 28VDC lamp load	

MATERIALS

- Case : mineral filled polyester UL94-V0
- Bushing and cover : zamac
- Actuator : brass, nickel or chrome plated, or anodized aluminium
- Contacts : silver alloy

AGENCY APPROVAL



CECC 96201-004

Availability : consult factory for details of approved models.

Marking : to order switches marked CECC, complete appropriate box of ordering format.

GENERAL SPECIFICATIONS

- Mechanical life : 40.000 cycles
- Torque : 2 Nm (1.47 Ft.lb) max. applied to nut
- Panel thickness : see "Mounting Accessories" on the following pages
- Operating temperature : -40°C to +85°C
- Moisture resistance : 56 days

3500 series

High performance toggle switches - environmentally sealed

Overview

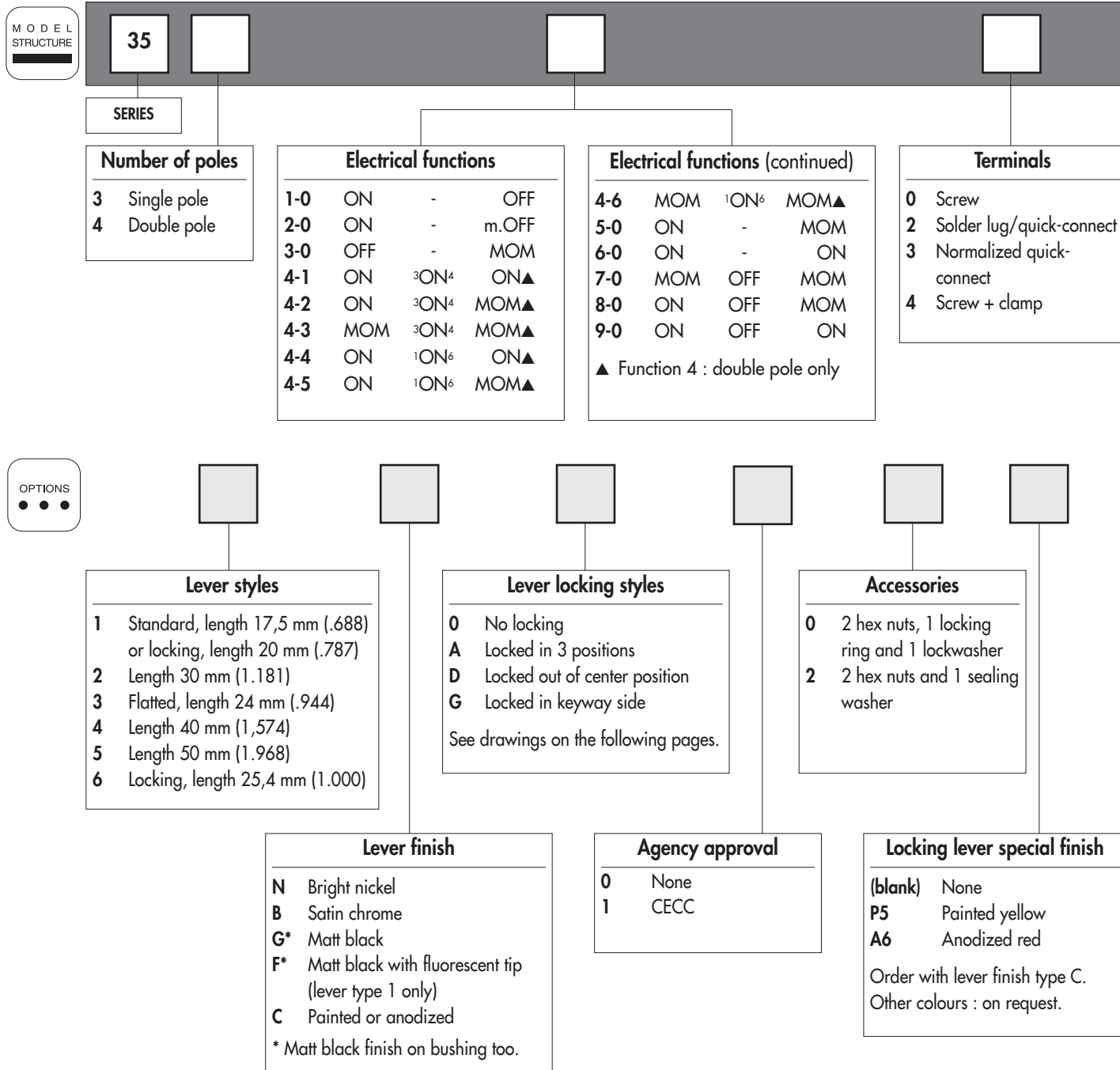

NOTICE : please note that not all combinations of above numbers are available. Refer to the following pages for further information.

ABOUT THIS SERIES

On the following pages, you will find successively :
 - model structure of switches
 - their options in the same order as in above chart

Dimensions : first dimensions are in mm while inches are shown as bracketted numbers.

Security caps are available to prevent inadvertent lever operation. They are presented in section I.



Packaging unit : 25 pieces

3500 series

High performance toggle switches - environmentally sealed

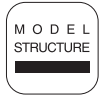

A

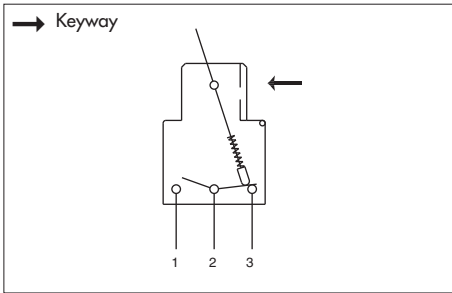

- Screw, solder lug or quick-connect terminals
- Also available with threaded terminals : consult factory
- Screw terminals + clamp : on request.

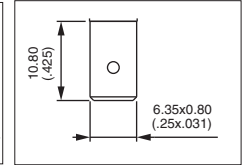
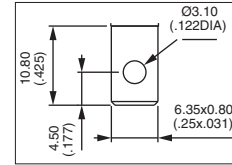
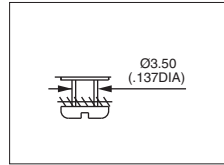

MODEL STRUCTURE

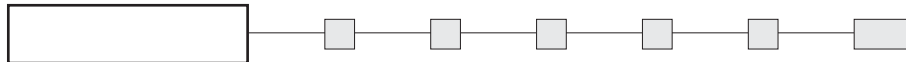

Shown with standard lever



FUNCTIONS			BASIC PART NUMBER					
III	II	I	Screw terminals		Solder lugs and quick-connect term.		Normalized quick-connect terminals	
A2-A3	* A3-B5	A1-A2	Single pole	Double pole	Single pole	Double pole	Single pole	Double pole
B5-B6	** A1-B5	B5-B4						
ON	-	OFF	3531-00	3541-00	3531-02	3541-02	3531-03	3541-03
ON	-	m.OFF	3532-00	3542-00	3532-02	3542-02	3532-03	3542-03
OFF	-	MOM	3533-00	3543-00	3533-02	3543-02	3533-03	3543-03
ON	ON *	ON		3544-10		3544-12		3544-13
ON	ON *	MOM		3544-20		3544-22		3544-23
MOM	ON *	MOM		3544-30		3544-32		3544-33
ON	ON **	ON		3544-40		3544-42		3544-43
ON	ON **	MOM		3544-50		3544-52		3544-53
MOM	ON **	MOM		3544-60		3544-62		3544-63
ON	-	MOM	3535-00	3545-00	3535-02	3545-02	3535-03	3545-03
ON	-	ON	3536-00	3546-00	3536-02	3546-02	3536-03	3546-03
MOM	OFF	MOM	3537-00	3547-00	3537-02	3547-02	3537-03	3547-03
ON	OFF	MOM	3538-00	3548-00	3538-02	3548-02	3538-03	3548-03
ON	OFF	ON	3539-00	3549-00	3539-02	3549-02	3539-03	3549-03

→ Keyway

* and **: A2-B4 and A2-B6 = jumper to be wired by the user.

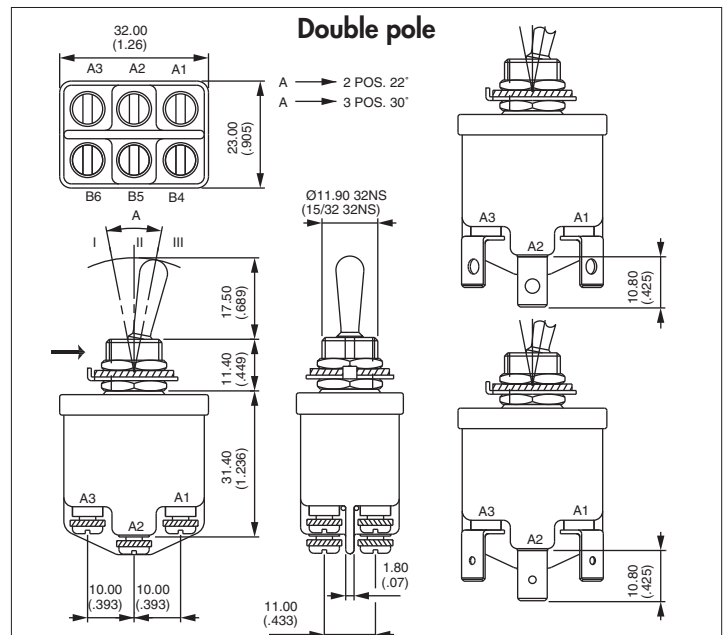
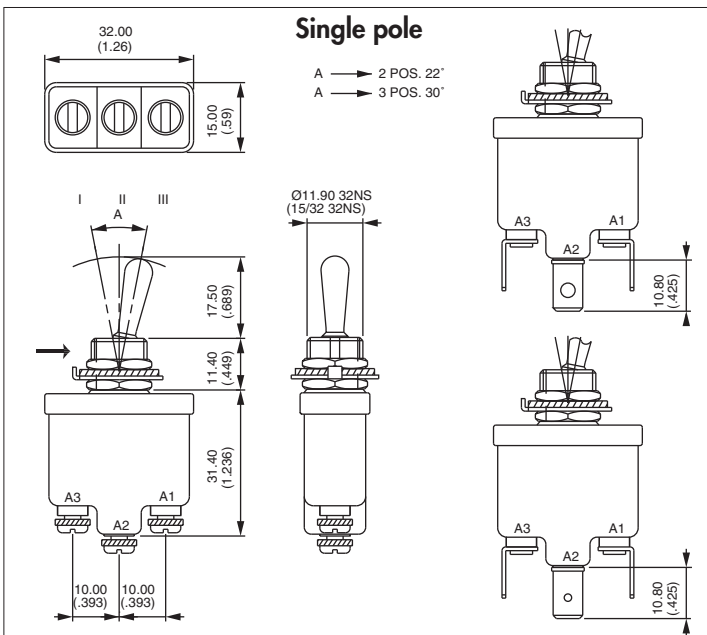



3500 series

High performance toggle switches - environmentally sealed

LEVER STYLES

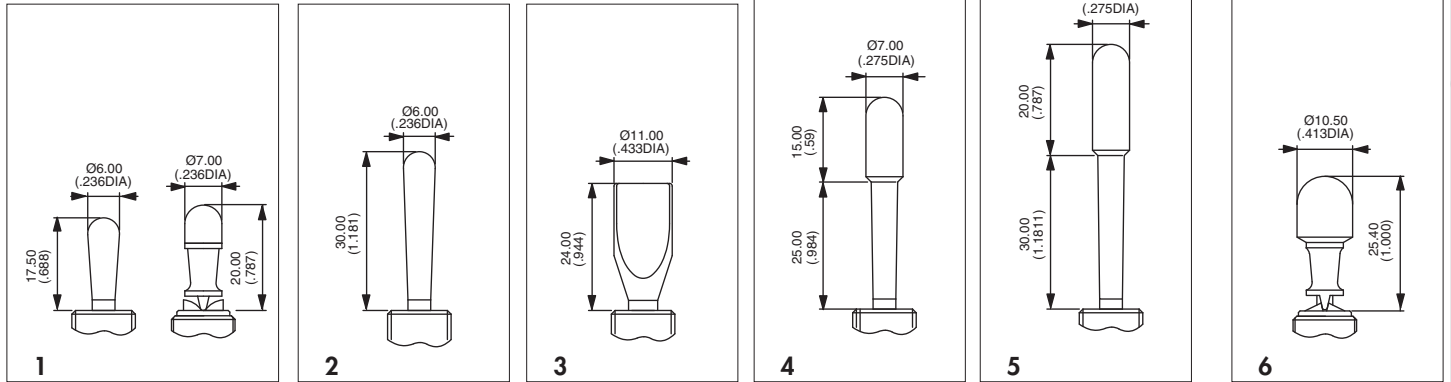
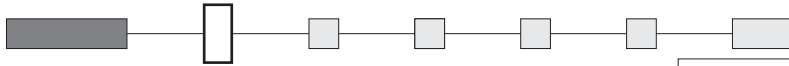

Standard

LEVER FINISH

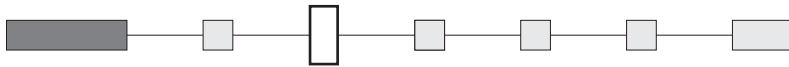

- N** Bright nickel
 - B** Satin chrome
 - G*** Matt black
 - F*** Matt black with fluorescent tip (available with lever type 1 only)
 - C** Painted or anodized (for locking lever only)
- * Matt black finish on bushing too.

LOCKING LEVER STYLES



0 No locking

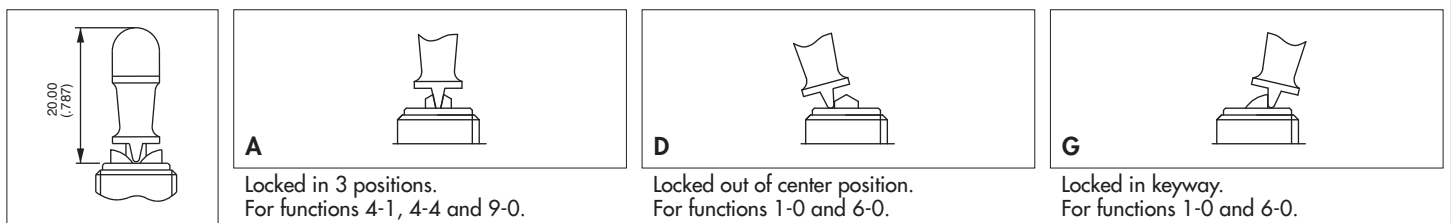

3500 series

High performance toggle switches - environmentally sealed



AGENCY APPROVAL

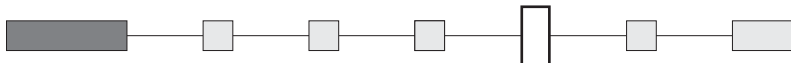

- 0 None
- 1 CECC

A

MOUNTING ACCESSORIES

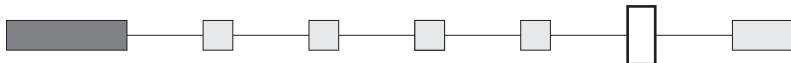

- 0 For NON-SEALED mounting (panel cut-out fig. 1, 2 or 3)
 2 hex nuts 14 mm (.551) across flats, 1 locking ring U121 or U12, 1 lockwasher U13
 Panel thickness : 5 mm (.196) max.
- 2 For SEALED mounting (panel cut-out fig. 2)
 2 hex nuts 14 mm (.551) across flats and 1 sealing washer U60
 Panel thickness : 4 mm (.157) max.

Special hardware : black cap nut U129. Order separately. See section I.

PANEL CUT-OUT

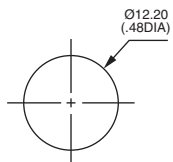

Figure 1

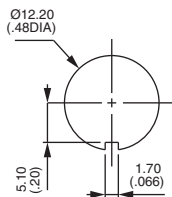

Figure 2

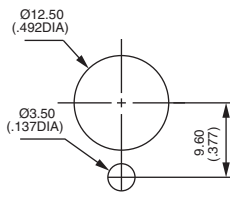
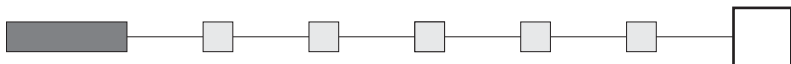

Figure 3

LOCKING LEVER SPECIAL FINISH



- (blank) None
- P5 Painted yellow
- A6 Anodized red

Order with lever finish type C.
 Other colours on request.

APEM 开关 Apem 代理商热线 4006-022-002 进口钮子开关价格查询

现货在线查询 www.tooye.net Apem Components cnr@tooye.net

高性能钮子开关 Apem 进口摇杆开关 toggle switch 进口钮子开关 IP67 防水钮子开关
Apem 开关查询热线 4006-022-002 Apem 代理商提供 Apem 开关选型手册 pdf 说明书样本
authorized Apem distributor 中国区获奖代理商

单极摇头开关, 双极钮子开关, 焊脚钮子开关, 螺丝端子摇头开关, 快接端子摇头开关
室外应用的摇杆开关, 正面达到 IP67 和 IP69K 的密封防水钮子开关, 防水摇头开关。
IP64 背面密封摇头开关. 通过欧洲 CECC 96000 认证标准

工作温度: -40° c to +85° C

防潮摇头开关 : 56 天

Apem 钮子开关应用: 专用车辆; 农用车辆; 工程车辆, 工程设备;
通讯设备, 通讯基站。

进口摇杆开关型号:

3531001G000 ;3531001GD00 ; 3531001N000 ; 3531001ND00 ;
3531001ND02 ; 3531003N000 ; 3531021N000 ; 3531033G000 ;
3533001N000 ; 3533001N010 ; 3533003N000 ; 3533003N012 ;
3535001N000 ; 3536001ND00 ; 3536021N000 ; 3537001N002 ;
3537001N012 ; 3537003N000 ; 3537021N000 ; 3538001N000 ;
3538021N3531001G000 ;3531001GD00 ; 3531033N000 ; 3531033ND00 ;
3531033ND02 ; 3531003N000 ; 3531021N000 ; 3531033G000 ;
3533033N000 ; 3533033N010 ; 3533003N000 ; 3533003N012 ;
3535033N000 ; 3536033ND00 ; 3536021N000 ; 3537033N002 ;
3537033N012 ; 3537003N000 ; 3537021N000 ; 3538033N000 ;
3538021N000 ; 3539033N000 ; 3539003N000 ; 3539005N000 ;
3539021N000 ; 3541033N000 ; 3541033N002 ; 3541003N000 ;
3541021N000 ; 3541031N010 ; 3544133G000 ; 3544301N000 ;
3545001B010 ; 3545033N000 ; 3546001B010 ; 3546001CG02A6;
3546001G000 ; 3546033N000 ; 3546033ND10 ; 3546026GD00 ;
3546033G000 ; 3547001B010 ; 3547033N000 ; 3547033N002 ;
3547021N000 ; 3547022G000 ; 3547031N002 ; 3548033N000 ;
3548033N010 ; 3549001B010 ; 3549033N000 ; 3549003N000 ;
3531-001GD00 ; 3531-033N000 ; 3531-033ND00 ; 3531-033ND02 ;
3531-003N000 ; 3531-021N000 ; 3531-033G000 ; 3533-033N000 ;
3533-033N010 ; 3533-003N000 ; 3533-003N012 ; 3535-033N000 ;
3536-033ND00 ; 3536-021N000 ; 3536-033N002 ; 3536-033N012 ;
3536-003N000 ; 3536-021N000 ;
3537-033ND00 ; 3537-033N002 ; 3537-033N012 ;
3537-003N000 ; 3537-021N000 ; 3538-033N000 ; 3538-021N000 ;
3539-033N000 ; 3539-003N000 ; 3539-005N000 ; 3539-021N000 ;
3541-033N000 ; 3541-033N002 ; 3541-003N000 ; 3541-021N000 ;
3541-031N010 ; 3544-133G000 ; 3544-301N000 ; 3545-001B010 ;
3545-033N000 ; 3546-001B010 ; 3546-001CG02A6; 3546-001G000 ;
3546-033N000 ; 3546-033ND10 ; 3546-026GD00 ; 3546-033G000 ;
3547-001B010 ; 3547-033N000 ; 3547-033N002 ; 3547-021N000 ;
3547-022G000 ; 3547-031N002 ; 3548-033N000 ; 3548-033N010 ;

APEM 开关 Apem 代理商热线 4006-022-002 进口钮子开关价格查询

现货在线查询 www.tooye.net

[Apem Components](http://www.tooye.net)

cnr@tooye.net

3549-001B010 ; 3549-033N000 ; 3549-003N000 ; 3531-001G000 ;000 ; 3539001N000 ;
3539003N000 ; 3539005N000 ;
3539021N000 ; 3541001N000 ; 3541001N002 ; 3541003N000 ;
3541021N000 ; 3541031N010 ; 3544133G000 ; 3544301N000 ;
3545001B010 ; 3545001N000 ; 3546001B010 ; 3546001CG02A6;
3546001G000 ; 3546001N000 ; 3546001ND10 ; 3546026GD00 ;
3546033G000 ; 3547001B010 ; 3547001N000 ; 3547001N002 ;
3547021N000 ; 3547022G000 ; 3547031N002 ; 3548001N000 ;
3548001N010 ; 3549001B010 ; 3549001N000 ; 3549003N000 ;
3531-001GD00 ; 3531-001N000 ; 3531-001ND00 ; 3531-001ND02 ;
3531-003N000 ; 3531-021N000 ; 3531-033G000 ; 3533-001N000 ;
3533-001N010 ; 3533-003N000 ; 3533-003N012 ; 3535-001N000 ;
3536-001ND00 ; 3536-021N000 ; 3537-001N002 ; 3537-001N012 ;
3537-003N000 ; 3537-021N000 ; 3538-001N000 ; 3538-021N000 ;
3539-001N000 ; 3539-003N000 ; 3539-005N000 ; 3539-021N000 ;
3541-001N000 ; 3541-001N002 ; 3541-003N000 ; 3541-021N000 ;
3541-031N010 ; 3544-133G000 ; 3544-301N000 ; 3545-001B010 ;
3545-001N000 ; 3546-001B010 ; 3546-001CG02A6; 3546-001G000 ;
3546-001N000 ; 3546-001ND10 ; 3546-026GD00 ; 3546-033G000 ;
3547-001B010 ; 3547-001N000 ; 3547-001N002 ; 3547-021N000 ;
3547-022G000 ; 3547-031N002 ; 3548-001N000 ; 3548-001N010 ;
3549-001B010 ; 3549-001N000 ; 3549-003N000 ; 3531-001G000 ;