



**SOT-23 Plastic-Encapsulate MOSFETS**

**AO3415 P-Channel Enhancement Mode Power MOSFET**

**Description**

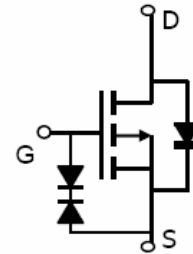
The AO3415 uses advanced trench technology to provide excellent  $R_{DS(ON)}$ , low gate charge and operation with gate voltages as low as 1.8V. This device is suitable for use as a load switch or in PWM applications. It is ESD protected.

**General Features**

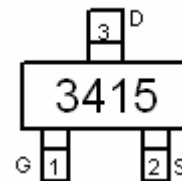
- $V_{DS} = -20V, I_D = -4A$
- $R_{DS(ON)} < 60m\Omega @ V_{GS} = -2.5V$
- $R_{DS(ON)} < 45m\Omega @ V_{GS} = -4.5V$
- ESD Rating: 2500V HBM
- High Power and current handling capability
- Lead free product is acquired
- Surface mount package

**Application**

- PWM application
- Load switch



Schematic diagram



Marking and pin Assignment



SOT-23 top view

**Package Marking and Ordering Information**

Device Marking	Device	Device Package	Reel Size	Tape width	Quantity
3415	AO3415	SOT-23	Ø180mm	8 mm	3000 units

**Absolute Maximum Ratings (TA=25°C unless otherwise noted)**

Parameter	Symbol	Limit	Unit
Drain-Source Voltage	$V_{DS}$	-20	V
Gate-Source Voltage	$V_{GS}$	±10	V
Drain Current-Continuous	$I_D$	-4	A
Drain Current-Pulsed (Note 1)	$I_{DM}$	-30	A
Maximum Power Dissipation	$P_D$	1.4	W
Operating Junction and Storage Temperature Range	$T_J, T_{STG}$	-55 To 150	°C

**Thermal Characteristic**

Thermal Resistance, Junction-to-Ambient (Note 2)	$R_{\theta JA}$	89.3	°C/W
--	-----------------	------	------

**Electrical Characteristics (TA=25°C unless otherwise noted)**

Parameter	Symbol	Condition	Min	Typ	Max	Unit
<b>Off Characteristics</b>						
Drain-Source Breakdown Voltage	$BV_{DSS}$	$V_{GS} = 0V, I_D = -250\mu A$	-20		-	V

# AO3415

Zero Gate Voltage Drain Current	$I_{DSS}$	$V_{DS}=-20V, V_{GS}=0V$	-	-	1	$\mu A$
Gate-Body Leakage Current	$I_{GSS}$	$V_{GS}=\pm 10V, V_{DS}=0V$	-	-	$\pm 10$	$\mu A$
<b>On Characteristics (Note 3)</b>						
Gate Threshold Voltage	$V_{GS(th)}$	$V_{DS}=V_{GS}, I_D=-250\mu A$	-0.35	-0.55	-0.9	V
Drain-Source On-State Resistance	$R_{DS(on)}$	$V_{GS}=-4.5V, I_D=-4A$	-	34	45	$m\Omega$
		$V_{GS}=-2.5V, I_D=-4A$	-	44	60	$m\Omega$
Forward Transconductance	$g_{FS}$	$V_{DS}=-5V, I_D=-4A$	8	-	-	S
<b>Dynamic Characteristics (Note4)</b>						
Input Capacitance	$C_{iss}$	$V_{DS}=-10V, V_{GS}=0V,$ $F=1.0MHz$	-	950	-	PF
Output Capacitance	$C_{oss}$		-	165	-	PF
Reverse Transfer Capacitance	$C_{rss}$		-	120	-	PF
<b>Switching Characteristics (Note 4)</b>						
Turn-on Delay Time	$t_{d(on)}$	$V_{DD}=-10V, R_L=2.5\Omega$ $V_{GS}=-4.5V, R_{GEN}=3\Omega$	-	12		nS
Turn-on Rise Time	$t_r$		-	10		nS
Turn-Off Delay Time	$t_{d(off)}$		-	19		nS
Turn-Off Fall Time	$t_f$		-	25		nS
Total Gate Charge	$Q_g$	$V_{DS}=-10V, I_D=-4A,$ $V_{GS}=-4.5V$	-	12		nC
Gate-Source Charge	$Q_{gs}$		-	1.4	-	nC
Gate-Drain Charge	$Q_{gd}$		-	3.6	-	nC
<b>Drain-Source Diode Characteristics</b>						
Diode Forward Voltage (Note 3)	$V_{SD}$	$V_{GS}=0V, I_S=-4A$	-	-	-1.2	V
Diode Forward Current (Note 2)	$I_S$		-	-	-4	A

## Notes:

1. Repetitive Rating: Pulse width limited by maximum junction temperature.
2. Surface Mounted on FR4 Board,  $t \leq 10$  sec.
3. Pulse Test: Pulse Width  $\leq 300\mu s$ , Duty Cycle  $\leq 2\%$ .
4. Guaranteed by design, not subject to production

## Typical Electrical and Thermal Characteristics

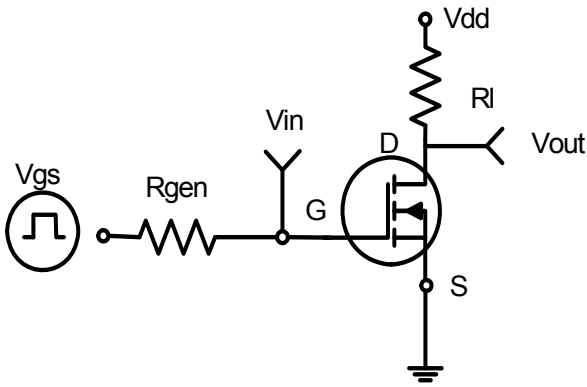


Figure 1: Switching Test Circuit

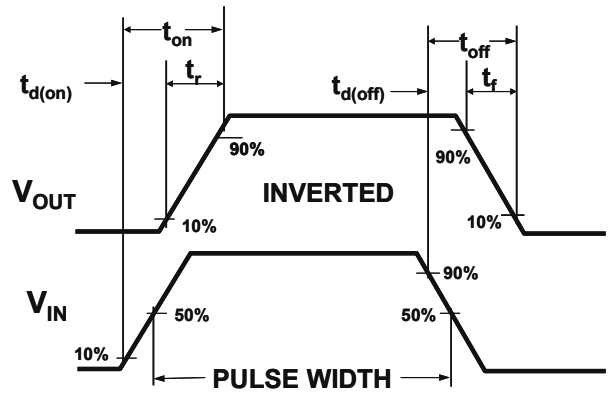


Figure 2: Switching Waveforms

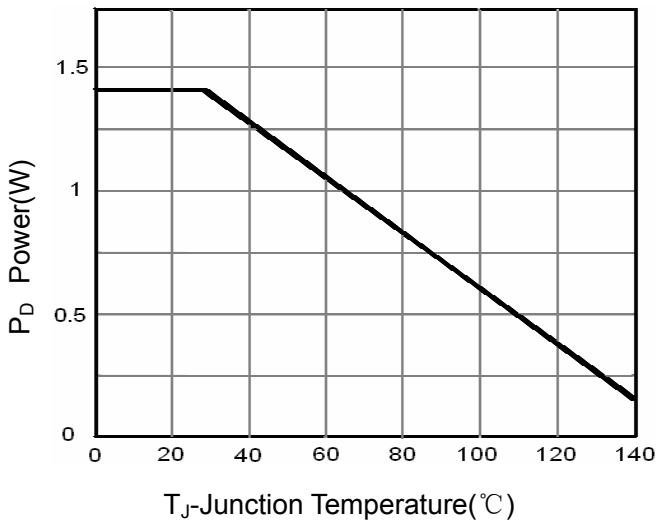


Figure 3 Power Dissipation

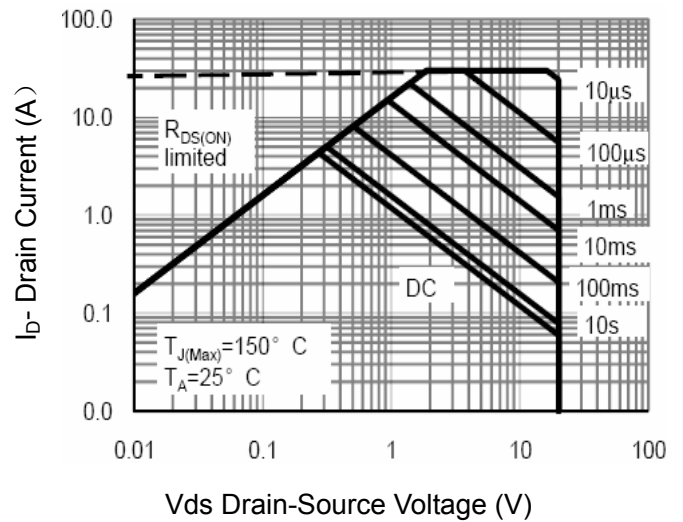


Figure 4 Safe Operation Area

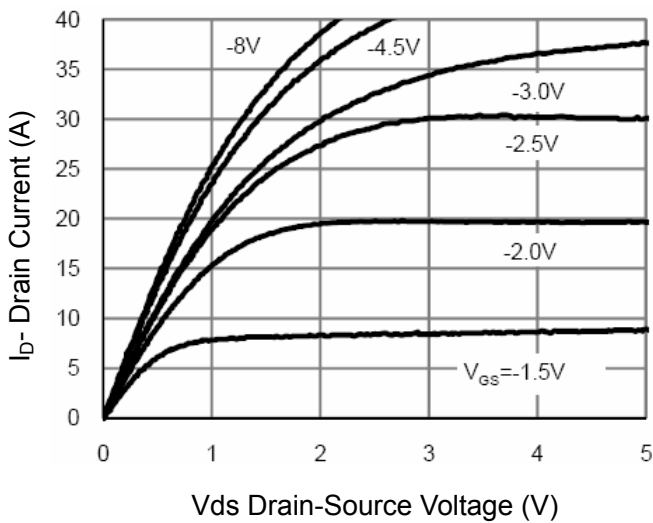


Figure 5 Output Characteristics

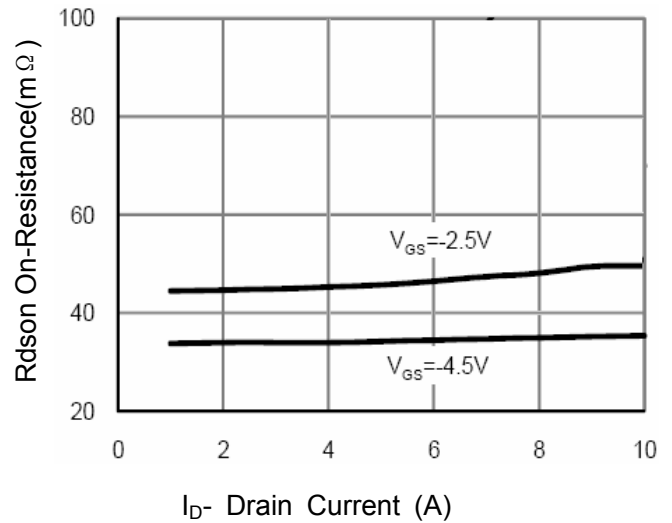
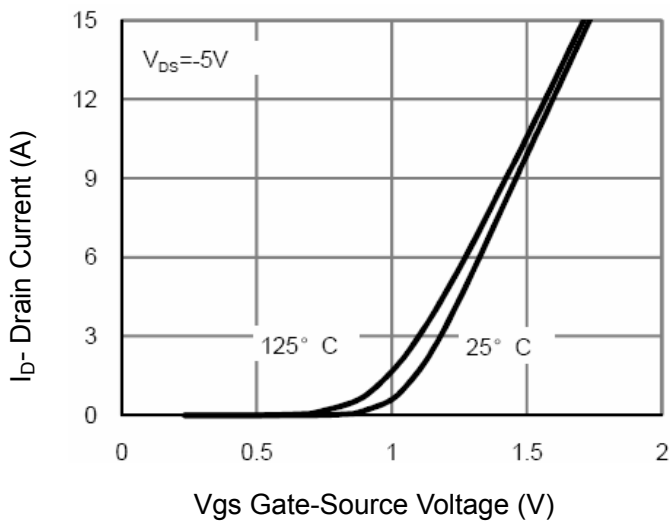
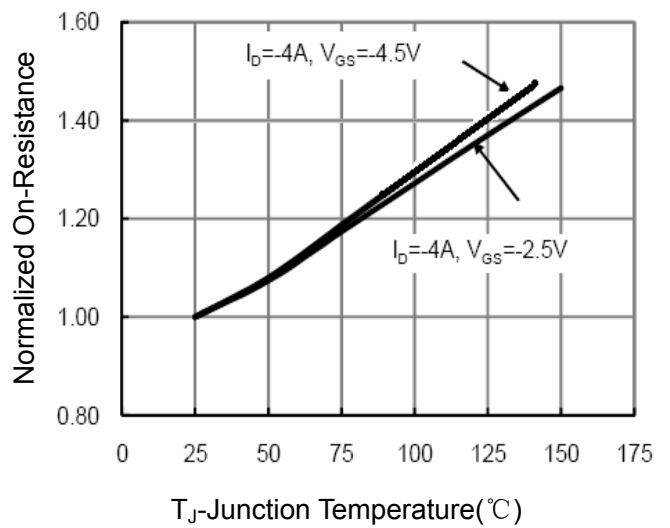


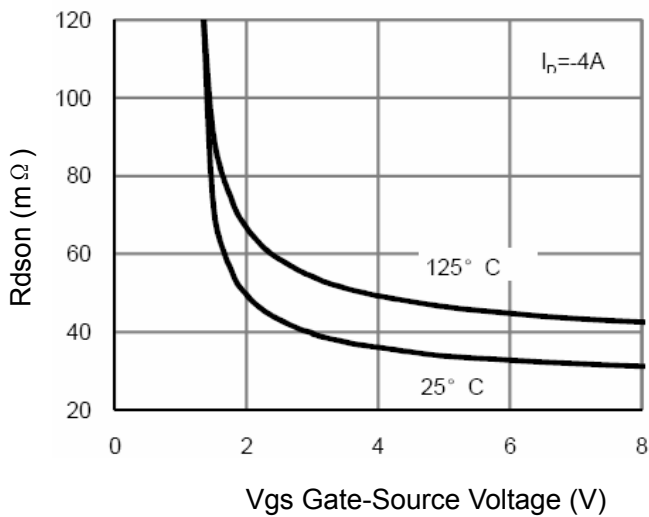
Figure 6 Drain-Source On-Resistance



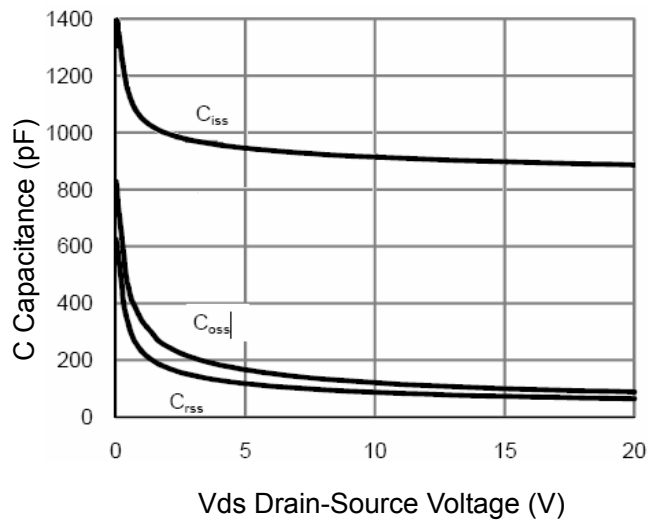
**Figure 7 Transfer Characteristics**



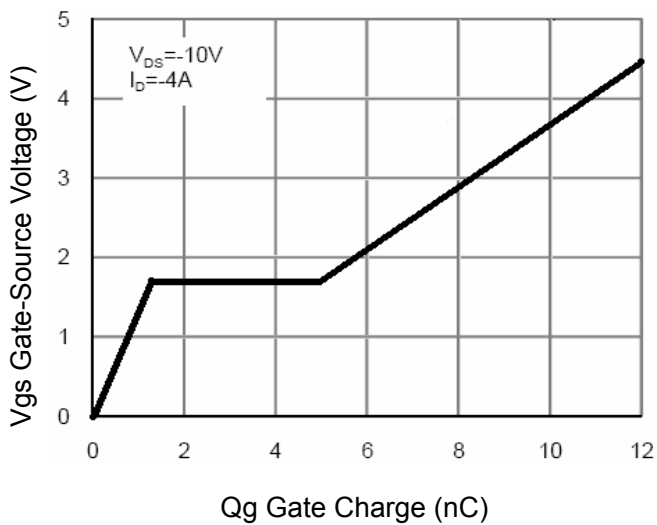
**Figure 8 Drain-Source On-Resistance**



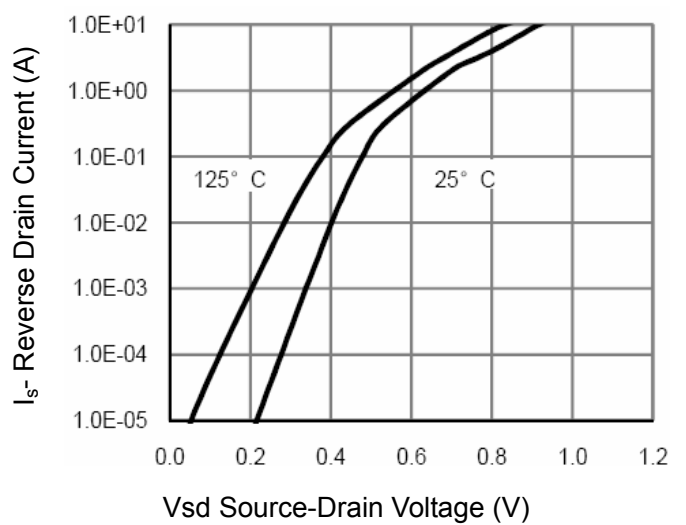
**Figure 9 Rdson vs Vgs**



**Figure 10 Capacitance vs Vds**

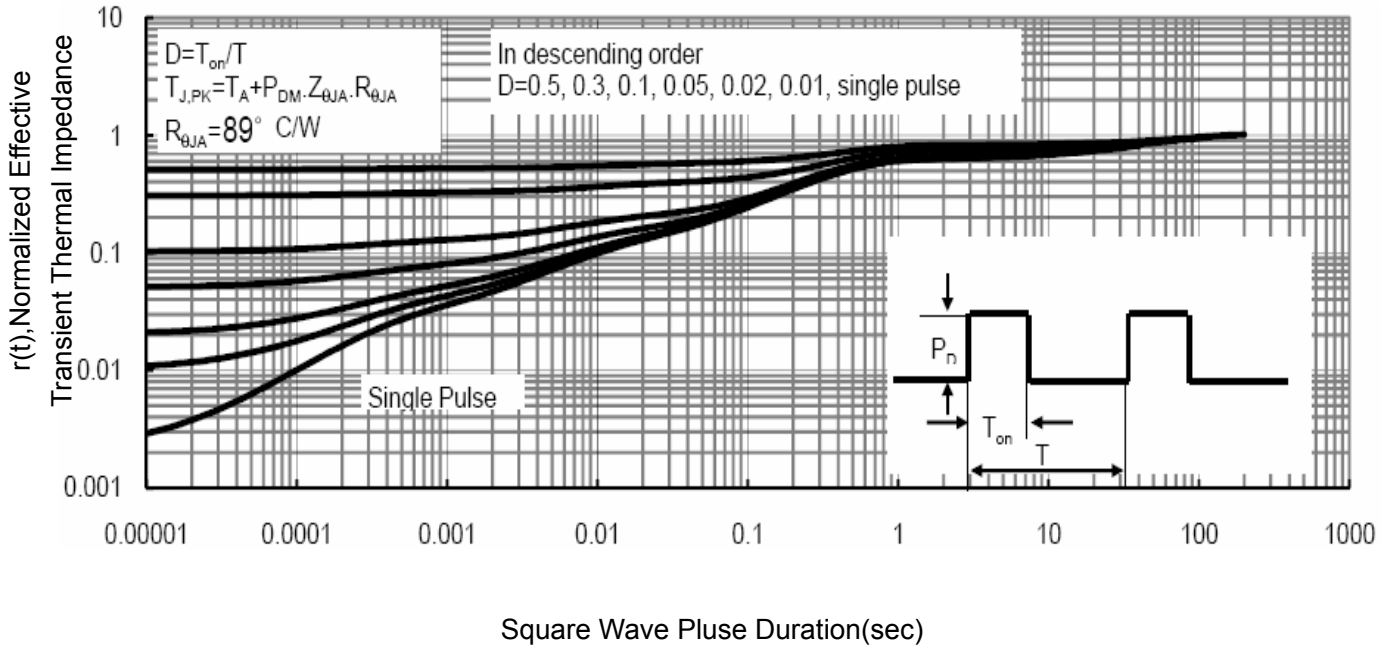


**Figure 11 Gate Charge**



**Figure 12 Source- Drain Diode Forward**

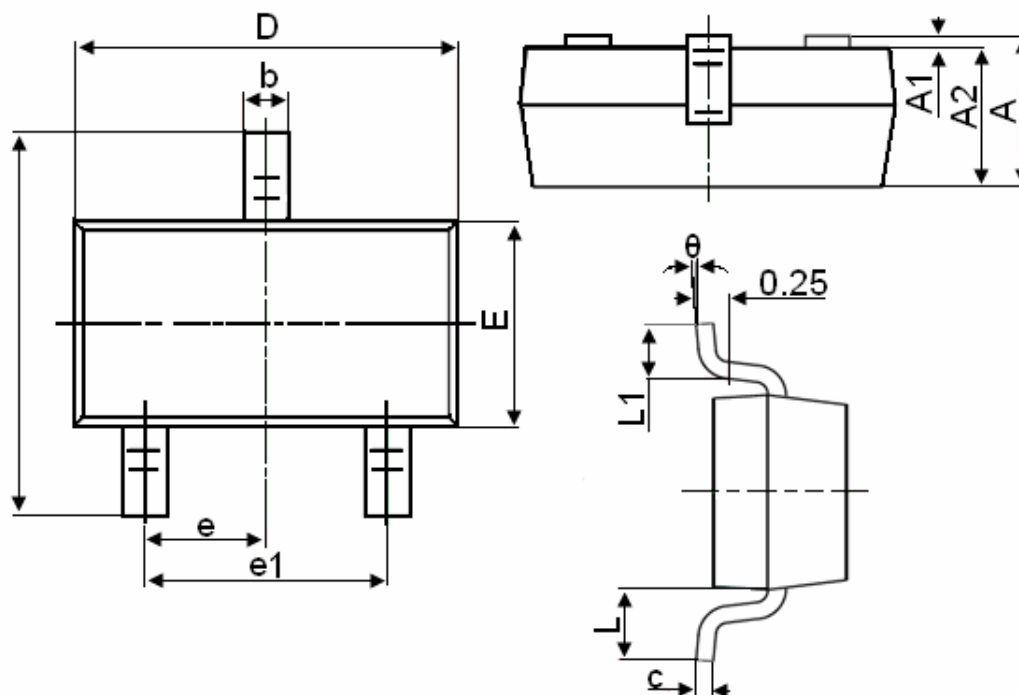
# AO3415



**Figure 13 Normalized Maximum Transient Thermal Impedance**

# AO3415

## SOT-23 Package Information



Symbol	Dimensions in Millimeters	
	MIN.	MAX.
A	0.900	1.150
A1	0.000	0.100
A2	0.900	1.050
b	0.300	0.500
c	0.080	0.150
D	2.800	3.000
E	1.200	1.400
E1	2.250	2.550
e	0.950TYP	
e1	1.800	2.000
L	0.550REF	
L1	0.300	0.500
θ	0°	8°

### Notes

1. All dimensions are in millimeters.
2. Tolerance  $\pm 0.10\text{mm}$  (4 mil) unless otherwise specified
3. Package body sizes exclude mold flash and gate burrs. Mold flash at the non-lead sides should be less than 5 mils.
4. Dimension L is measured in gauge plane.
5. Controlling dimension is millimeter, converted inch dimensions are not necessarily exact.