

Ultra Fine Pitch (0.4mm), Ultra Low Profile (1mm) IDC Connector for Micro Coaxial Cable (#42 AWG)

USL SERIES

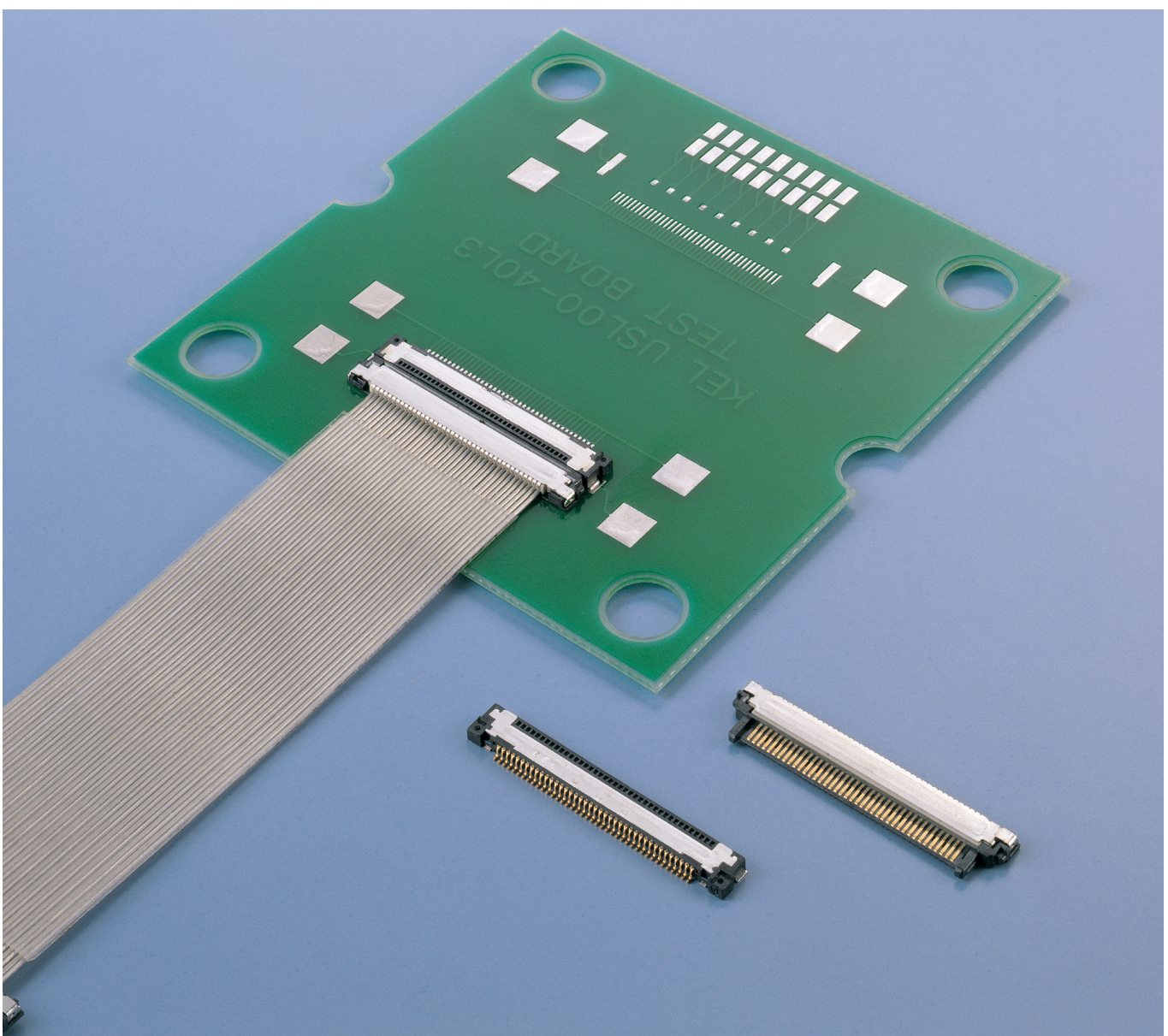

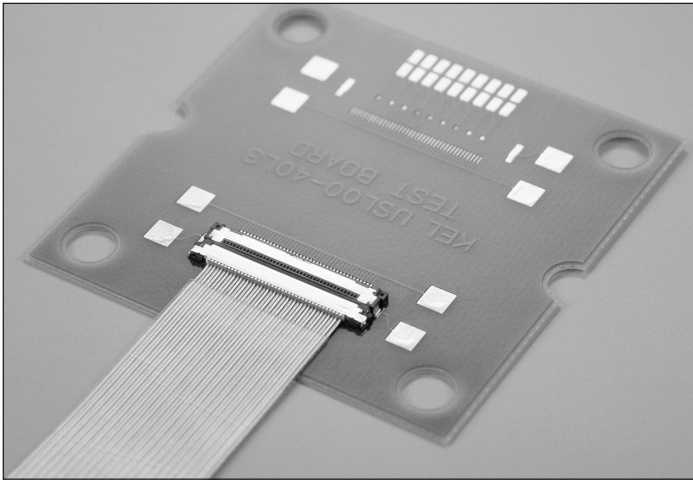

FEATURES

- Ultra fine pitch 0.4mm
- Low profile 1mm
- More than 50% space saving compared to our SSL Series (0.5mm pitch)
- For micro coaxial cable (#42AWG)
- Metal shell on connector provides excellent EMI protection and mechanical strength
- IDC cable assembly (No solder connection)
- RoHS compliance

SPECIFICATIONS

- | | |
|-----------------------------------|-------------------------------------|
| ● Insulator material | : Glass-filled LCP (UL94V-0), Black |
| ● Contact material | : Copper alloy |
| ● Contact plating | : Gold over Nickel |
| ● Shell material | : Copper alloy |
| ● Shell plating | : Tin copper over Nickel |
| ● IDC cover material | : Glass-filled LCP (UL94V-0), White |
| ● Current rating | : 0.25A per contact |
| ● Contact resistance | : 100mΩ max. |
| ● Dielectric withstanding voltage | : 200V AC for 1 minute |
| ● Insulation resistance | : 100MΩ min. at 250V DC |
| ● Operating temperature | : -40°C to +85°C |

* The base and cover for the plug are sold separately. Please contact sales for inquiries and orders.

ORDER CODE

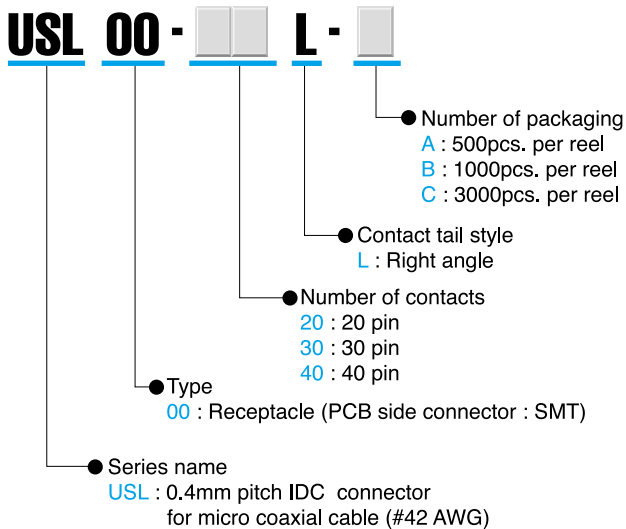

ORDER CODE

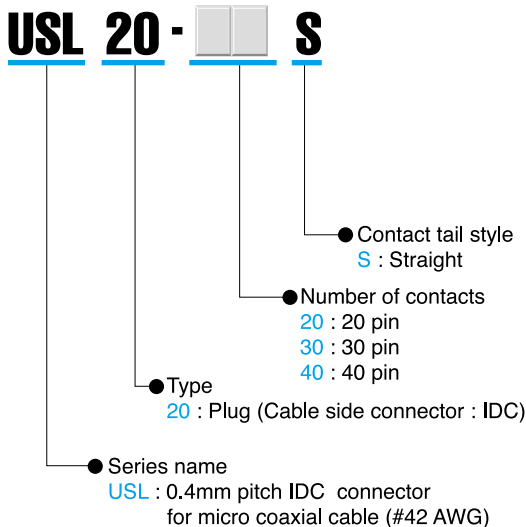

USL00-□□L-□ (Receptacle, Right angle)

Unit:mm(inch)

Receptacle (Right angle)

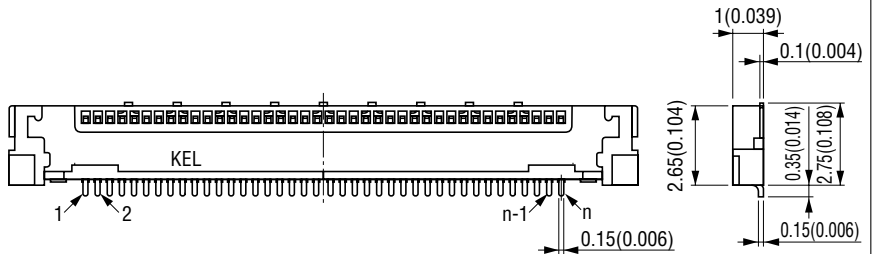
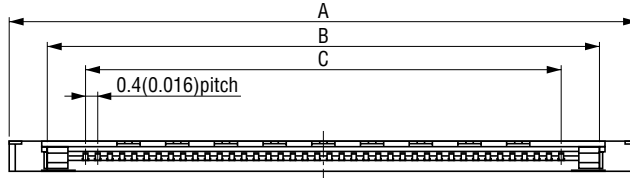
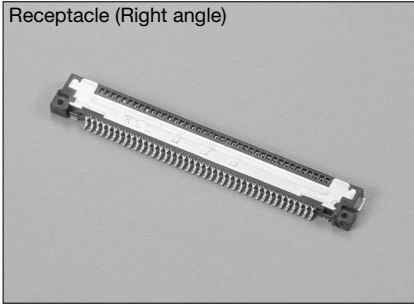

Packaging style
 Embossed tape

Part Number	Number of packaging
USL00-□□L-A	500
USL00-□□L-B	1,000
USL00-□□L-C	3,000

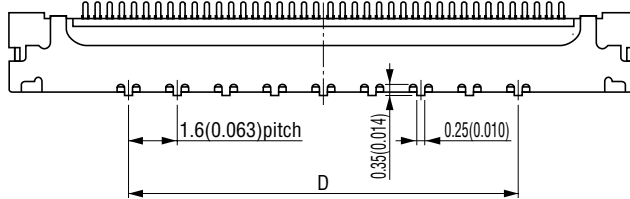
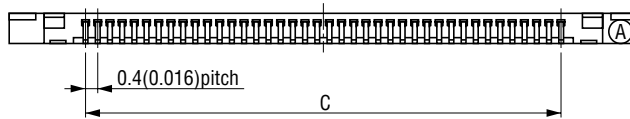

■ Product Table / Dimensions

No. of contacts	Part Number	A	B	C	D	E	F
20	USL00-20L-□	12.6 (0.496)	10.1 (0.398)	7.6 (0.299)	6.4 (0.252)	0.6 (0.024)	12.8 (0.504)
30	USL00-30L-□	16.6 (0.654)	14.1 (0.555)	11.6 (0.457)	9.6 (0.378)	1.0 (0.039)	16.8 (0.661)
40	USL00-40L-□	20.6 (0.811)	18.1 (0.713)	15.6 (0.614)	12.8 (0.504)	1.4 (0.055)	20.8 (0.819)

Printed Circuit Board Layout (Component Side View)

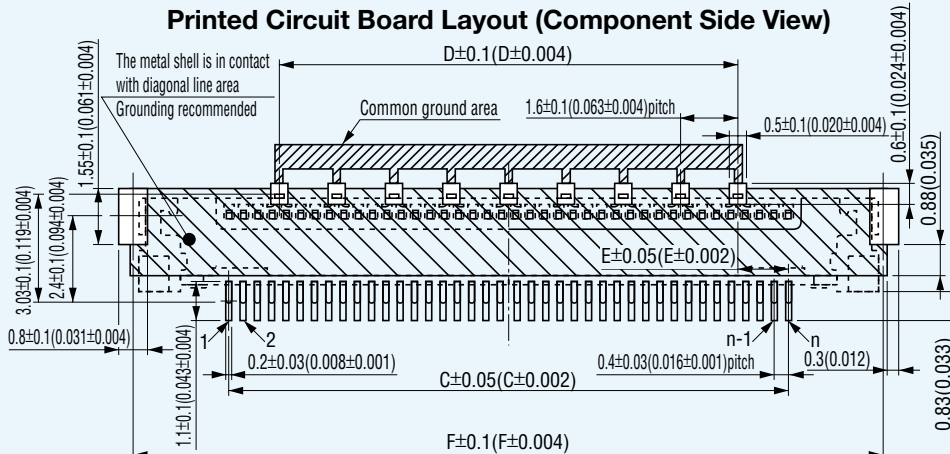

"n" is number of contacts.

USL20-□□S (Plug, IDC)

Plug (Straight)

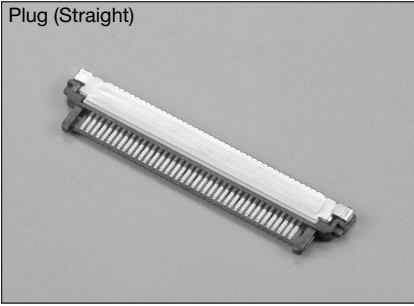

Unit:mm(inch)

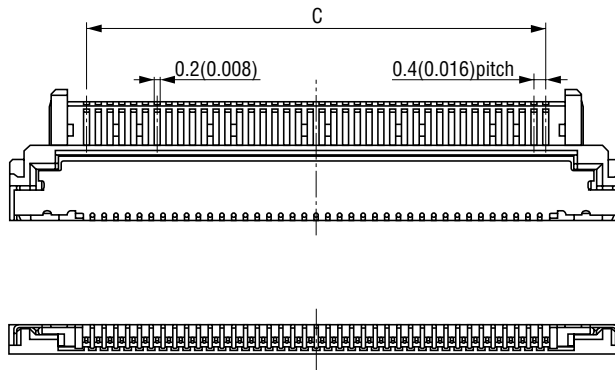
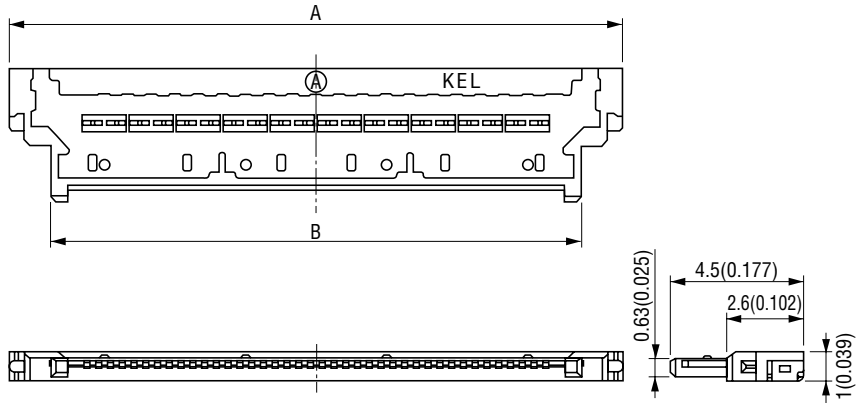

Packaging style
Tray

■ Product Table / Dimensions

No. of contacts	Part Number	A	B	C	Number of packaging
20	USL20-20S	12.8 (0.504)	10.1 (0.398)	7.6 (0.299)	160
30	USL20-30S	16.8 (0.661)	14.1 (0.555)	11.6 (0.457)	120
40	USL20-40S	20.8 (0.819)	18.1 (0.713)	15.6 (0.614)	100

Mating Variation

Unit:mm(inch)

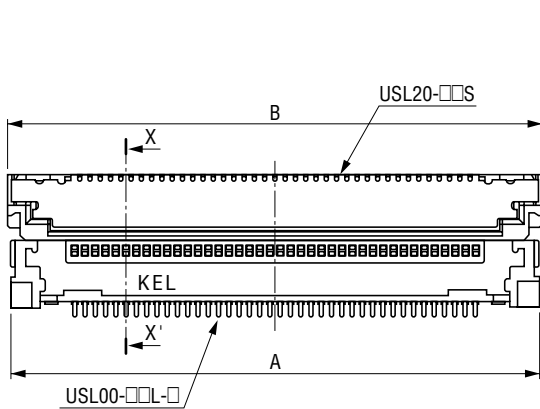

X-X' Cross Section

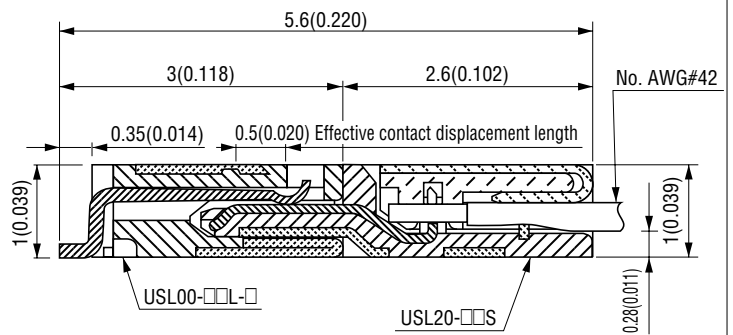

■ Number of Contact / Dimensions

No. of contact	A	B
20	12.6 (0.496)	12.8 (0.504)
30	16.6 (0.654)	16.8 (0.661)
40	20.6 (0.811)	20.8 (0.819)

● **ORDER CODE**

USL 20- SS- . - ()

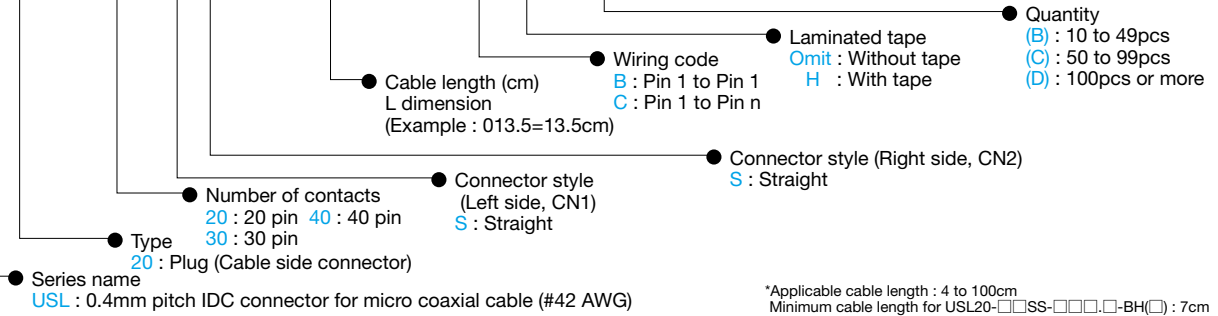

CABLE ASSEMBLY STYLE

Wiring Code : Pin 1 to Pin 1 Unit:mm(inch)

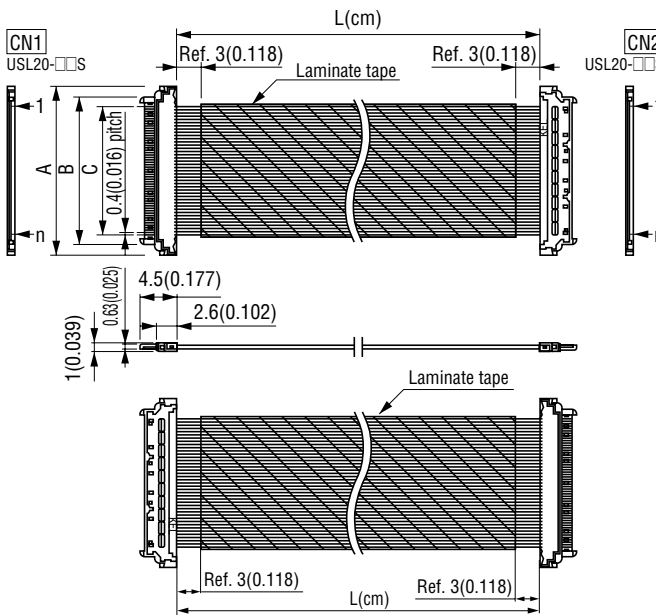

Wiring Code : Pin 1 to Pin n Unit:mm(inch)

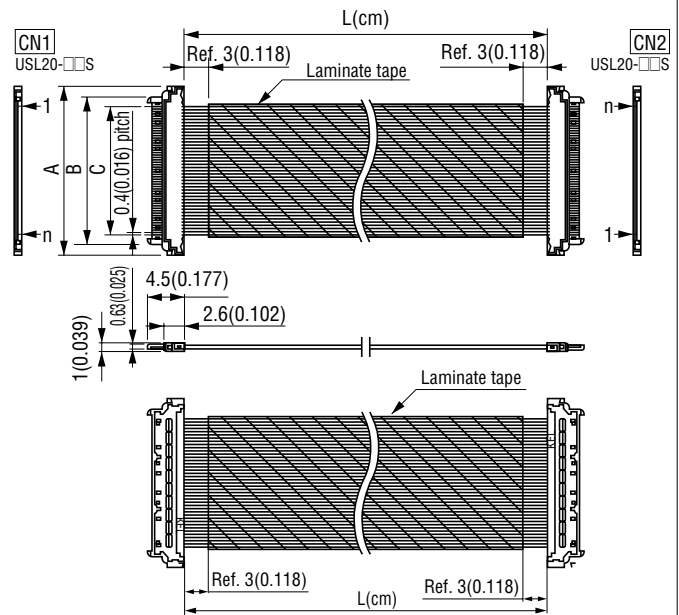

■ **Product Table / Dimensions**

No. of contacts	Part Number	A	B	C
20	USL20-20SS-□□□□-B□(□)	12.8 (0.504)	10.1 (0.398)	7.6 (0.299)
30	USL20-30SS-□□□□-B□(□)	16.8 (0.661)	14.1 (0.555)	11.6 (0.457)
40	USL20-40SS-□□□□-B□(□)	20.8 (0.819)	18.1 (0.713)	15.6 (0.614)

■ **Product Table / Dimensions**

No. of contacts	Part Number	A	B	C
20	USL20-20SS-□□□□-C□(□)	12.8 (0.504)	10.1 (0.398)	7.6 (0.299)
30	USL20-30SS-□□□□-C□(□)	16.8 (0.661)	14.1 (0.555)	11.6 (0.457)
40	USL20-40SS-□□□□-C□(□)	20.8 (0.819)	18.1 (0.713)	15.6 (0.614)

*Please contact your local sales office for inquiries regarding cable length and tolerance.

*Laminated tape is designed to be a little wider than the cable width. Please contact your local sales office for further details.

ORDER CODE

USL+S 20 - [] - [] . [] - [] ([])

- Series name
USL+S : 0.4mm pitch IDC connector for micro coaxial cable (#42 AWG)
Left side connector, CN1 / USL20 series
Right side connector, CN2 / USLS20 series
- Type
20 : Plug (Cable side connector)
- Number of contacts
20 : 20 pin
30 : 30 pin
40 : 40 pin
- Cable length (cm)
L dimension
(Example : 013.5=13.5cm)
- Wiring code
B : Pin 1 to Pin 1
C : Pin 1 to Pin n
- Laminated tape
Omit : Without tape
H : With tape
- Quantity
(B) : 10 to 49pcs
(C) : 50 to 99pcs
(D) : 100pcs or more

*Applicable cable length : 4 to 100cm
Minimum cable length for USL+S20-□□-□□□□-□-□-□□ : 7cm

CABLE ASSEMBLY STYLE

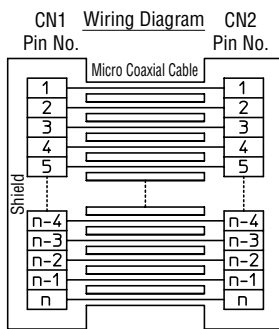
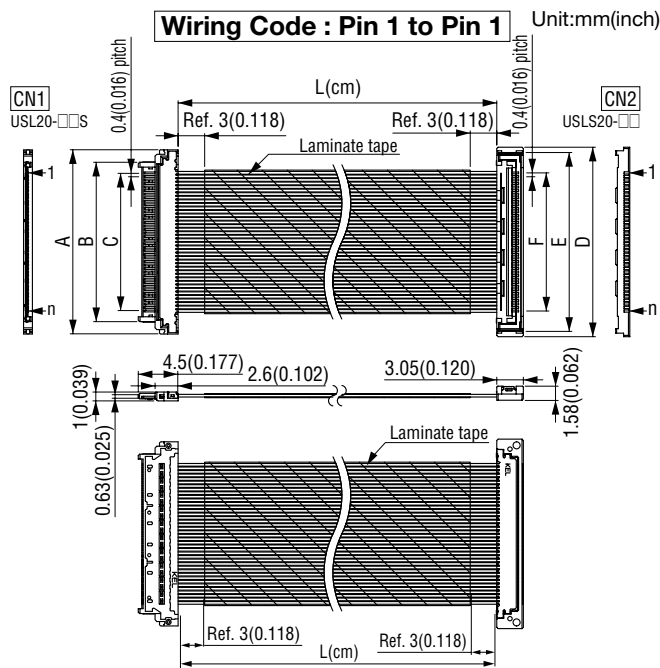

* "n" is number of contacts.

Product Table / Dimensions

No. of contacts	Part Number	A	B	C	D	E	F
20	USL+S20-20-□□□□-□-□-□□(□)	12.8 (0.504)	10.1 (0.398)	7.6 (0.299)	13.4 (0.528)	12.0 (0.472)	7.6 (0.299)
30	USL+S20-30-□□□□-□-□-□□(□)	16.8 (0.661)	14.1 (0.555)	11.6 (0.457)	17.4 (0.685)	16.0 (0.630)	11.6 (0.457)
40	USL+S20-40-□□□□-□-□-□□(□)	20.8 (0.819)	18.1 (0.713)	15.6 (0.614)	21.4 (0.843)	20.0 (0.787)	15.6 (0.614)

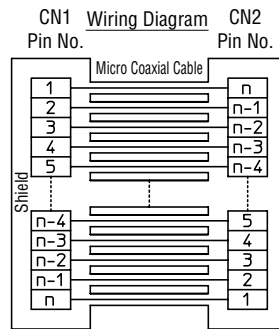
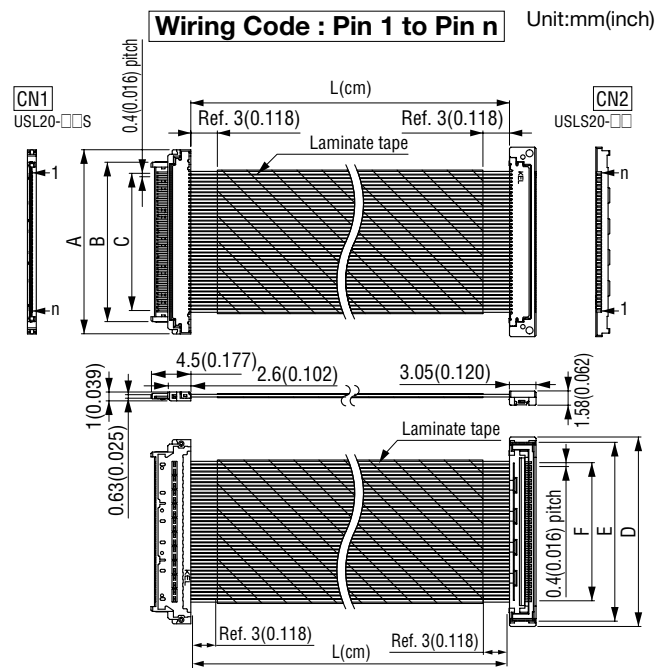

* "n" is number of contacts.

Product Table / Dimensions

No. of contacts	Part Number	A	B	C	D	E	F
20	USL+S20-20-□□□□-□-□-□□(□)	12.8 (0.504)	10.1 (0.398)	7.6 (0.299)	13.4 (0.528)	12.0 (0.472)	7.6 (0.299)
30	USL+S20-30-□□□□-□-□-□□(□)	16.8 (0.661)	14.1 (0.555)	11.6 (0.457)	17.4 (0.685)	16.0 (0.630)	11.6 (0.457)
40	USL+S20-40-□□□□-□-□-□□(□)	20.8 (0.819)	18.1 (0.713)	15.6 (0.614)	21.4 (0.843)	20.0 (0.787)	15.6 (0.614)

*Please contact your local sales office for inquiries regarding cable length and tolerance.

*Laminated tape is designed to be a little wider than the cable width. Please contact your local sales office for further details.