



**DC COMPONENTS CO., LTD.**

RECTIFIER SPECIALISTS

RS1A  
THRU  
RS1M

**TECHNICAL SPECIFICATIONS OF SURFACE MOUNT FAST RECOVERY RECTIFIER**

VOLTAGE RANGE - 50 to 1000 Volts

CURRENT - 1.0 Ampere

**FEATURES**

- \* Ideal for surface mounted applications
- \* Low leakage current
- \* Glass passivated junction

**MECHANICAL DATA**

- \* Case: Molded plastic
- \* Epoxy: UL 94V-0 rate flame retardant
- \* Terminals: Solder plated, solderable per MIL-STD-750, Method 2026
- \* Polarity: As marked
- \* Mounting position: Any
- \* Weight: 0.064 gram

**MAXIMUM RATINGS AND ELECTRICAL CHARACTERISTICS**

Ratings at 25 °C ambient temperature unless otherwise specified.  
Single phase, half wave, 60 Hz, resistive or inductive load.  
For capacitive load, derate current by 20%.



SMA (DO-214AC)

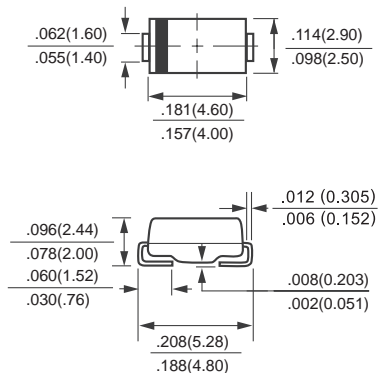

Dimensions in inches and (millimeters)

	SYMBOL	RS1A	RS1B	RS1D	RS1G	RS1J	RS1K	RS1M	UNITS
Maximum Recurrent Peak Reverse Voltage	VRRM	50	100	200	400	600	800	1000	Volts
Maximum RMS Voltage	VRMS	35	70	140	280	420	560	700	Volts
Maximum DC Blocking Voltage	VDC	50	100	200	400	600	800	1000	Volts
Maximum Average Forward Rectified Current at TA = 55°C	Io	1.0							Amps
Peak Forward Surge Current 8.3 ms single half sine-wave superimposed on rated load (JEDEC Method)	IFSM	30							Amps
Maximum Forward Voltage at 1.0A DC	VF	1.3							Volts
Maximum DC Reverse Current at @TA = 25°C	IR	5.0							uAmps
Rated DC Blocking Voltage @TA = 125°C		150							
Maximum Reverse Recovery Time (Note 3)	trr	150			250	500		nSec	
Maximum Thermal Resistance (Note 2)	RθJL	30							°C/W
Typical Junction Capacitance (Note 1)	Cj	15							pF
Operating and Storage Temperature Range	TJ, TSTG	-65 to + 175							°C

NOTES : 1. Measured at 1.0 MHz and applied reverse voltage of 4.0VDC  
 2. Thermal Resistance (Junction to Ambient), .24in<sup>2</sup> (6.0mm<sup>2</sup>) copper pads to each terminal.  
 3. Test Conditions: IF = 0.5A, IR = 1.0A, IRR = 0.25A

# RATING AND CHARACTERISTIC CURVES ( RS1A THRU RS1M )

FIG. 1 - TYPICAL FORWARD CURRENT DERATING CURVE

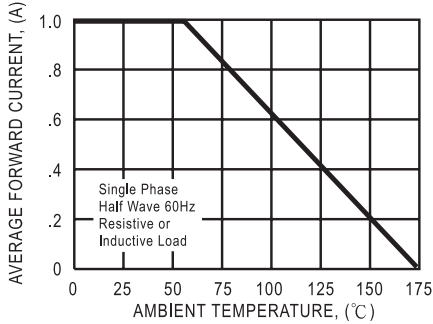

FIG. 2 - MAXIMUM NON-REPETITIVE FORWARD SURGE CURRENT

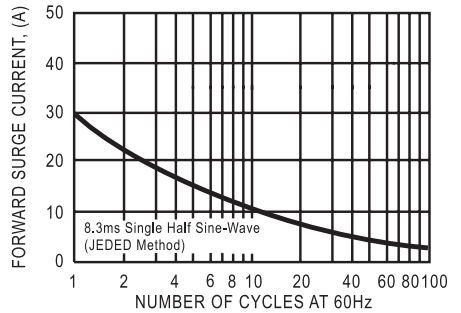

FIG. 3 - TYPICAL REVERSE CHARACTERISTICS

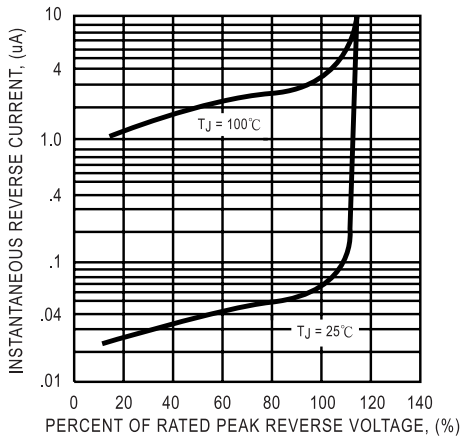

FIG. 4 - TYPICAL INSTANTANEOUS FORWARD CHARACTERISTICS

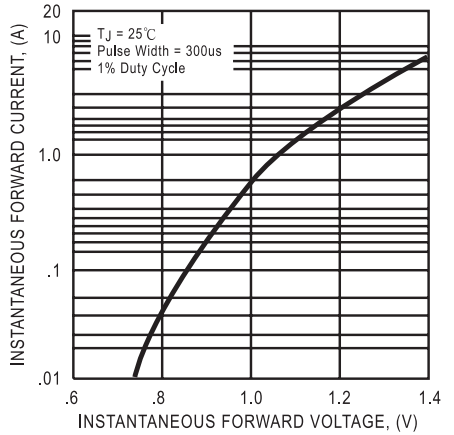

FIG. 5 - TEST CIRCUIT DIAGRAM AND REVERSE RECOVERY TIME CHARACTERISTIC

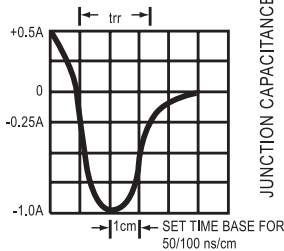
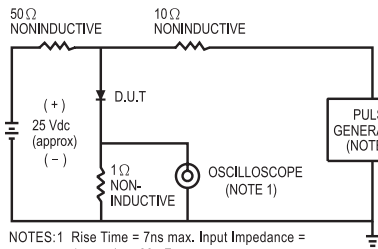

FIG. 6 - TYPICAL JUNCTION CAPACITANCE

