

### Features

- Glass Passivated Die Construction
- Fast Recovery Time For High Efficiency
- Low Forward Voltage Drop and High Current Capability
- Surge Overload Rating to 50A Peak
- Ideally Suited for Automated Assembly
- Plastic Material: UL Flammability Classification Rating 94V-0

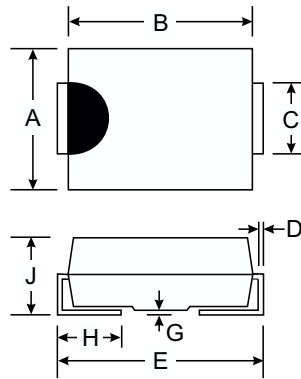

Dim	SMA		SMB	
	Min	Max	Min	Max
A	2.29	2.92	3.30	3.94
B	4.00	4.60	4.06	4.57
C	1.27	1.63	1.96	2.21
D	0.15	0.31	0.15	0.31
E	4.80	5.59	5.00	5.59
G	0.10	0.20	0.10	0.20
H	0.76	1.52	0.76	1.52
J	2.01	2.62	2.00	2.62

All Dimensions in mm

### Mechanical Data

- Case: Molded Plastic
- Terminals: Solder Plated Terminal - Solderable per MIL-STD-202, Method 208
- Polarity: Cathode Band or Cathode Notch
- SMA Weight: 0.065 grams (approx.)
- SMB Weight: 0.09 grams (approx.)
- Mounting Position: Any
- Marking: Type Number

AA, BA, DA, GA, JA, KA, MA Suffix Designates SMA Package  
A, B, D, G, J, K Suffix Designates SMB Package

### Maximum Ratings and Electrical Characteristics $T_A = 25^\circ\text{C}$ unless otherwise specified

Single phase, half wave, 60Hz, resistive or inductive load.  
For capacitive load, derate current by 20%.

Characteristic	Symbol	RS2 A/AA	RS2 B/BA	RS2 D/DA	RS2 G/GA	RS2 J/JA	RS2 K/KA	RS2 M/MA	Unit
Peak Repetitive Reverse Voltage Working Peak Reverse Voltage DC Blocking Voltage	$V_{RRM}$ $V_{RWM}$ $V_R$	50	100	200	400	600	800	1000	V
RMS Reverse Voltage	$V_{R(RMS)}$	35	70	140	280	420	560	700	V
Average Rectified Output Current @ $T_T = 120^\circ\text{C}$	$I_O$	1.5							A
Non-Repetitive Peak Forward Surge Current 8.3ms Single half sine-wave Superimposed on Rated Load (JEDEC Method)	$I_{FSM}$	50							A
Forward Voltage @ $I_F = 1.5\text{A}$	$V_{FM}$	1.3							V
Peak Reverse Current @ $T_A = 25^\circ\text{C}$ at Rated DC Blocking Voltage @ $T_A = 125^\circ\text{C}$	$I_{RM}$	5.0 200							$\mu\text{A}$
Reverse Recovery Time (Note 3)	$t_{rr}$	150				250	500		ns
Typical Junction Capacitance (Note 2)	$C_j$	30							pF
Typical Thermal Resistance, Junction to Terminal (Note 1)	$R_{\theta JT}$	20							K/W
Operating and Storage Temperature Range	$T_j, T_{STG}$	-65 to +150							$^\circ\text{C}$

- Notes:
1. Thermal Resistance: Junction to terminal, unit mounted on PC board with 5.0 mm<sup>2</sup> (0.013 mm thick) copper pads as heat sink.
  2. Measured at 1.0MHz and applied reverse voltage of 4.0V DC.
  3. Reverse Recovery Test Conditions:  $I_F = 0.5\text{A}$ ,  $I_R = 1.0\text{A}$ ,  $I_{rr} = 0.25\text{A}$ . See Figure 5.

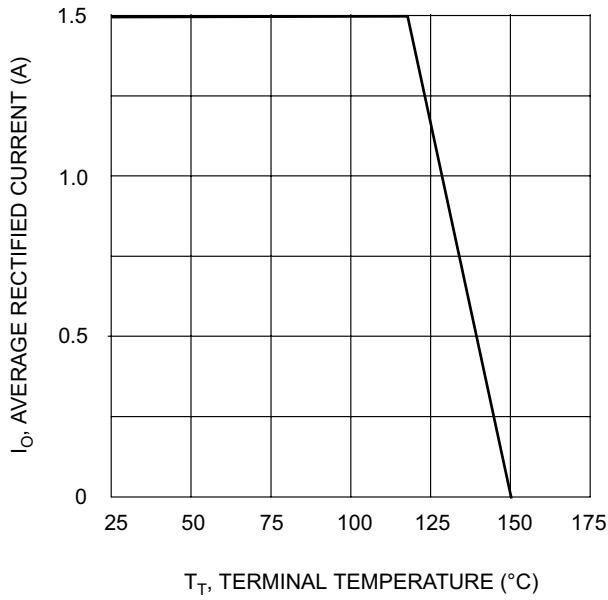

Fig. 1 Forward Current Derating Curve

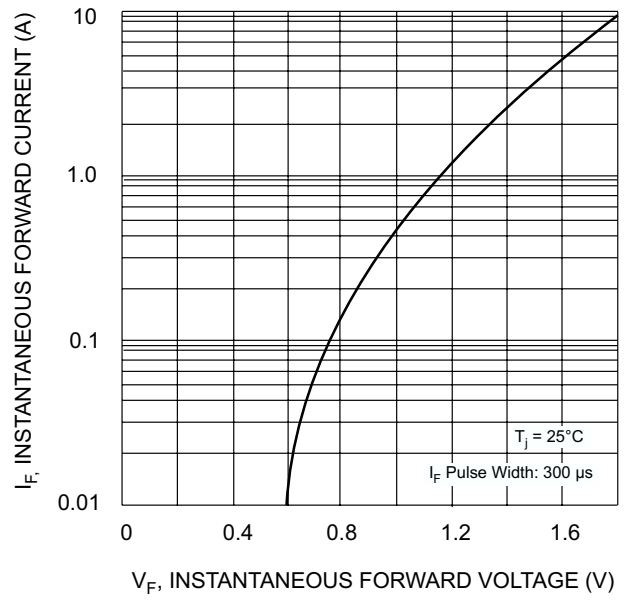

Fig. 2 Typical Forward Characteristics

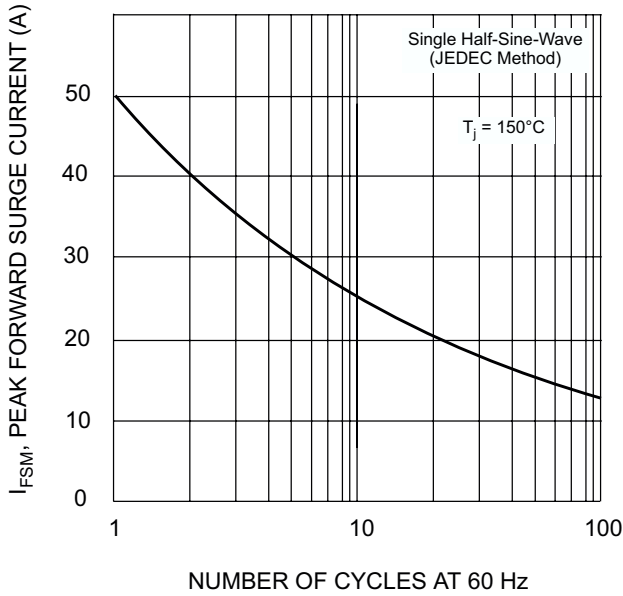

Fig. 3 Forward Surge Current Derating Curve

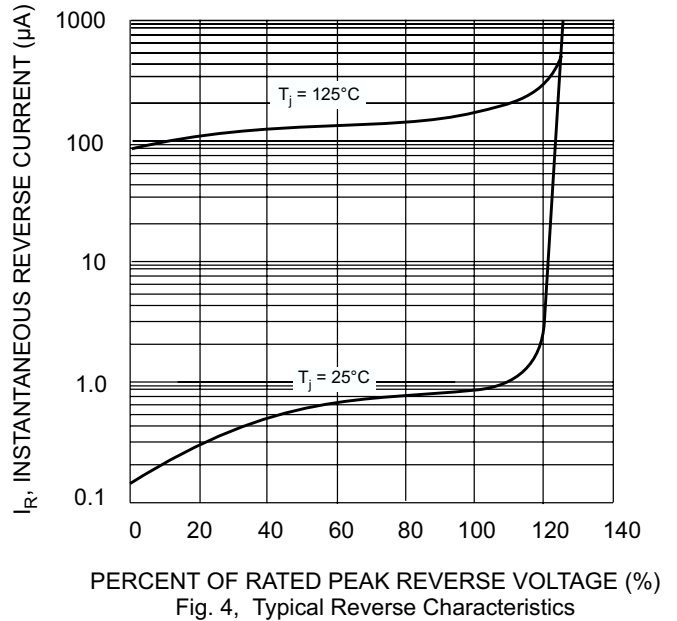
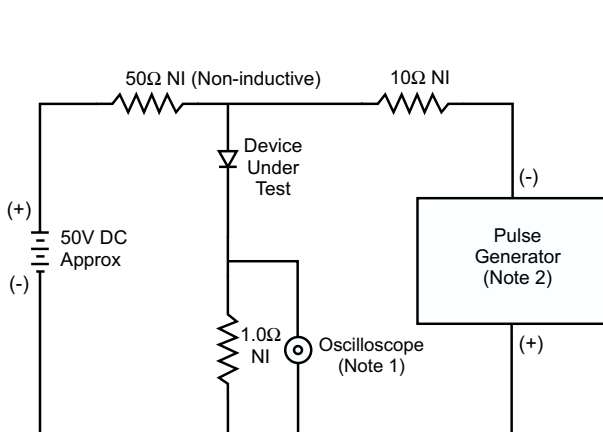
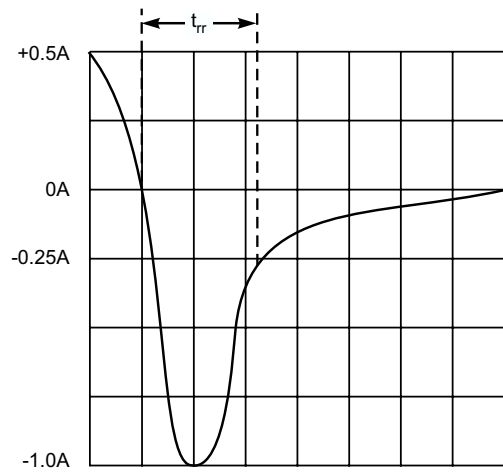

Fig. 4, Typical Reverse Characteristics



- Notes:
1. Rise Time = 7.0ns max. Input Impedance = 1.0M $\Omega$ , 22pF.
  2. Rise Time = 10ns max. Input Impedance = 50 $\Omega$ .



Set time base for 50/100 ns/cm

Fig. 5 Reverse Recovery Time Characteristic and Test Circuit