



# ES2A THRU ES2M

## SURFACE MOUNT SUPER FAST RECTIFIER

Reverse Voltage - 50 to 1000 Volts Forward Current - 2.0 Amperes

### DO-214AA (HSMB) (Round Lead)

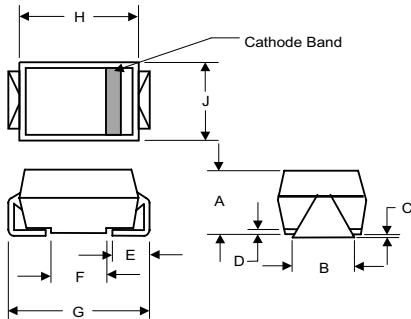

DIM	INCHES		MM		NOTE
	MIN	MAX	MIN	MAX	
A	.078	.116	1.98	2.95	
B	.075	.089	1.90	2.25	
C	.002	.008	.05	.20	
D		.02		.51	
E	.035	.055	.90	1.40	
F	.065	.091	1.65	2.32	
G	.205	.224	5.21	5.69	
H	.160	.180	4.06	4.57	
J	.130	.155	3.30	3.94	

### FEATURES

- ◆ Lead Free Finish/Rohs Compliant (Note1) ("P" Suffix designates Compliant. See ordering information)
- ◆ Case Material: Molded Plastic. UL Flammability
- ◆ Classification Rating 94V-0 and MSL rating 1
- ◆ Easy Pick And Place
- ◆ High Temp Soldering: 260°C for 10 Seconds At Terminals
- ◆ Ultrafast Recovery Times For High Efficiency

### MECHANICAL DATA

**Case:** JEDEC DO-214AA molded plastic body over passivated chip  
**Terminals:** Solder plated, solderable per MIL-STD-750, Method 2026

**Polarity:** Color band denotes cathode end

**Mounting Position:** Any

**Weight:** 0.005 ounce, 0.138 grams

### MAXIMUM RATINGS AND ELECTRICAL CHARACTERISTICS

Ratings at 25°C ambient temperature unless otherwise specified.

Single phase half-wave 60Hz, resistive or inductive load, for capacitive load current derate by 20%.

Catalog Number	SYMBOLS	ES2A	ES2B	ES2C	ES2D	ES2E	ES2G	ES2J	ES2K	ES2M	UNITS
Maximum repetitive peak reverse voltage	$V_{RRM}$	50	100	150	200	300	400	600	800	1000	VOLTS
Maximum RMS voltage	$V_{RMS}$	35	70	105	140	210	280	420	560	700	VOLTS
Maximum DC blocking voltage	$V_{DC}$	50	100	150	200	300	400	600	800	1000	VOLTS
Maximum average forward rectified current at $T_L=55^\circ\text{C}$	$I_{(AV)}$	2.0									Amps
Peak forward surge current 8.3ms single half sine-wave superimposed on rated load (JEDEC Method)	$I_{FSM}$	50.0									Amps
Maximum instantaneous forward voltage at 2.0A	$V_F$	0.975			1.35			1.7			Volts
Maximum DC reverse current $T_A=25^\circ\text{C}$ at rated DC blocking voltage $T_A=100^\circ\text{C}$	$I_R$	5.0 150.0									$\mu\text{A}$
Maximum reverse recovery time (NOTE 1)	$t_{rr}$	50			60			100			ns
Typical junction capacitance (NOTE 2)	$C_J$	25.0									pF
Typical thermal resistance (NOTE 3)	$R_{\theta JA}$	20.0									$^\circ\text{C/W}$
Operating junction and storage temperature range	$T_J T_{STG}$	-50 to +150									$^\circ\text{C}$

**Note:** 1.Reverse recovery condition  $I_F=0.5\text{A}, I_R=1.0\text{A}, I_{rr}=0.25\text{A}$

2.Measured at 1MHz and applied reverse voltage of 4.0V D.C.

3.Pulse test: Pulse width 200 sec, Duty cycle 2%

4.High Temperature Solder Exemptions Applied, see EU Directive Annex 7.

# RATINGS AND CHARACTERISTIC CURVES ES2A THRU ES2M

Figure 1  
Typical Forward Characteristics

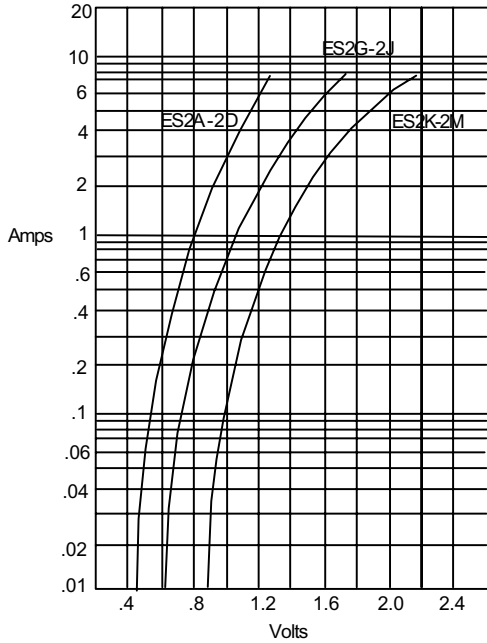

Instantaneous Forward Current - Amperes versus  
Instantaneous Forward Voltage - Volts

Figure 2  
Forward Derating Curve

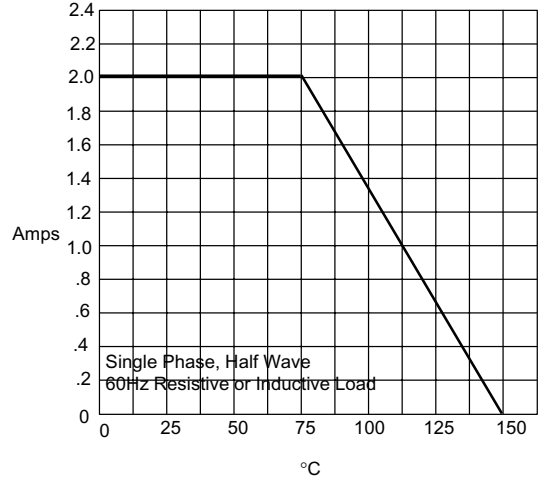

Average Forward Rectified Current - Amperes versus  
Ambient Temperature - °C

Figure 3  
Junction Capacitance

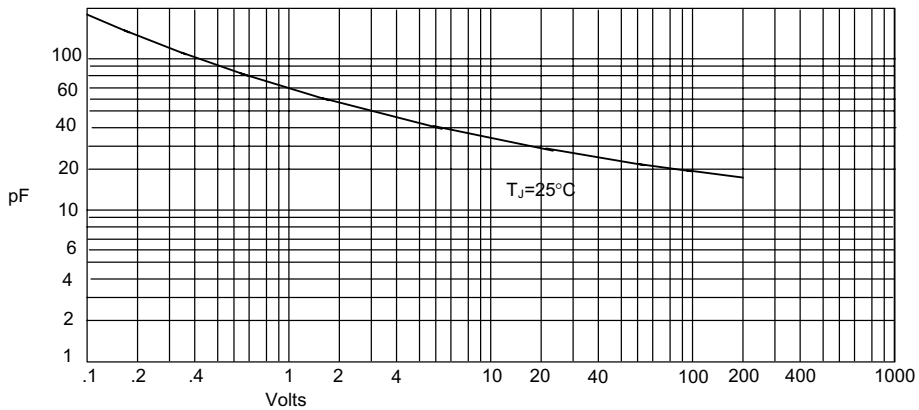

Junction Capacitance - pF versus  
Reverse Voltage - Volts

# RATINGS AND CHARACTERISTIC CURVES ES2A THRU ES2M

Figure 4  
Peak Forward Surge Current

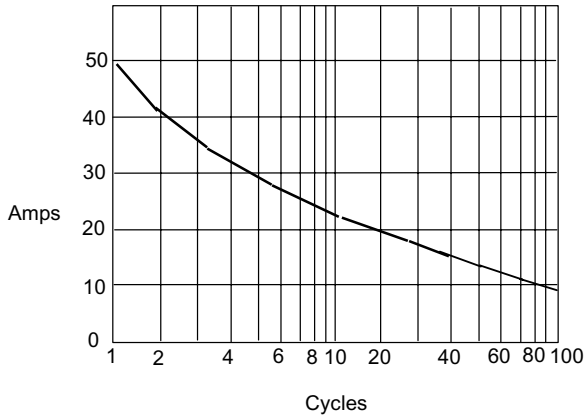

Peak Forward Surge Current - Amperes *versus*  
Number Of Cycles At 60Hz - Cycles

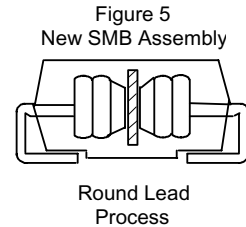
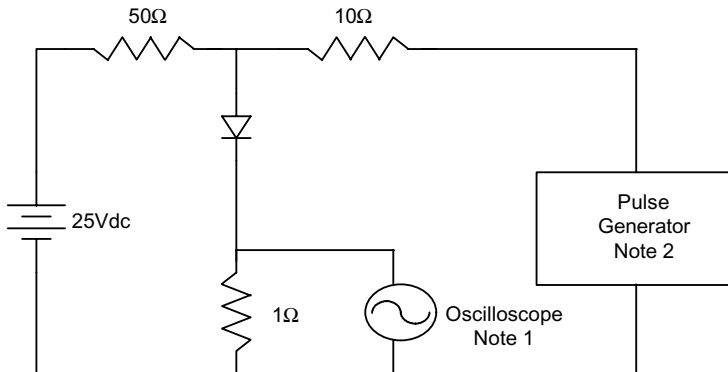

Figure 6  
Reverse Recovery Time Characteristic And Test Circuit Diagram



Notes:

1. Rise Time = 7ns max.  
Input impedance = 1 megohm, 22pF
2. Rise Time = 10ns max.  
Source impedance = 50 ohms
3. Resistors are non-inductive

