

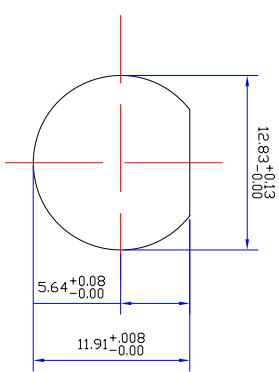

Product NO.		DOSIN-802-0016		
REV	DESCRIPTION	DWN	DATE	APPROVEN
A	First Issue	JIM	2012/11/02	John kine

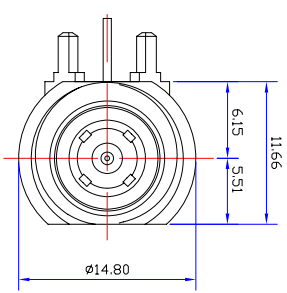
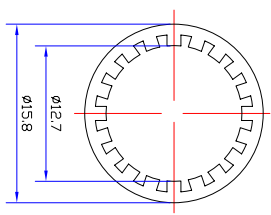
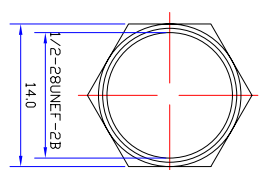
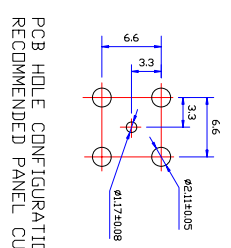
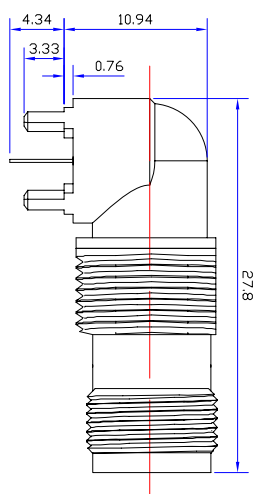
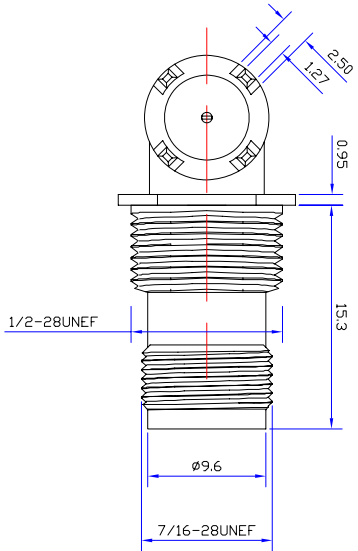

Specifications
 Frequency Range: DC~3G
 VSWR: 1.3MAX
 Working Voltage: 500V rms @ sea level
 Insulation Resistance: 5000 Ohms min
 Temperature Range: -55°C T0 +155°C
 Relative Temperature: ≤95% (40°C ±2°C)
 Drawings products are in line with ROHS standards

NOTE:

DRAWN	Zelin Zhang	2012/11/10
CHECKED		

Tolerance	0-6 6-30 30-120 Angular	±0.15 ±0.20 ±0.5 ±2°
View		
UNIT	MM	
SCALE	1:1	

Name: TNC CONNECTOR DNN

DOSIN Dosin Industrial(H.K)Co.Ltd
 东莞市德奈五金电子有限公司
 Dosin Hardware Electronics Co.,Ltd
 E-mail: dosin2005@163.com
 dosin2005@dosing.com
 dosin2005@dosing-china.com
 Web: http://www.dosing.com
 TEL: (0086)769-81153906
 FAX: (0086)769-81875836

3	BODY	ZINC	NICKEL	1
2	INSULATOR	POM	WHITE	1
1	PIN	BRASS	GOLD	1
NO	DESCRIPTION	MATERIAL	FINISH	QTY

APPROVALS	19/04/2012
<i>John Kine</i>	

UNIT	MM
SCALE	1:1

SIZE	Product NO.	CAD FILE	SHEET: 1 OF 1
A	DOSIN-802-0016	D/company drawings/BD	