



ISSUE NO :

Rev:

DATE OF ISSUE :

SPECIFICATION
MODEL : SPMWHT541MD5WAP0S0

Approved rank :
 V_F(AZ, A1, A2, A3, A4)
 CIE(P1, P2, P3, P4, P5, P6, P7, P8, P9, PA)
 I_v(S1, S2, S3)

MP5630 CRI80 WHITE LED P0 RANK

CUSTOMER :	
CHECKED	APPROVED

SAMSUNG ELECTRONICS			
DRAWN	CHECKED		APPROVED
	SALES	QUALITY	

SAMSUNG ELECTRONICS
 95, Samsung 2-ro, Giheung-gu
 Yongin-City, Gyeonggi-do 446-711, KOREA

Contents

1. Product Outline	-----	3
2. Absolute Maximum Rating	-----	3
3. Characteristics	-----	3
4. Chromaticity Diagram	-----	4
5. Typical Characteristic Graph	-----	5
6. Outline Drawing & Dimension	-----	6
7. Reliability Test Items & Conditions	-----	7
8. Solder Conditions	-----	8
9. Taping Dimension	-----	9
10. Label Structure	-----	10
11. Lot Number	-----	10
12. Reel Packing Structure	-----	11
13. Aluminum Vinyl Bag	-----	12
14. Precaution For Use	-----	13
15. Hazard Substance Analysis (SGS)	-----	15
16. Hazard Substance Analysis (SVHC)	-----	21
17. Revision History	-----	35

1. Product Outline

1) Feature

- . Lead Frame Type LED Package (5.6 * 3.0 * t 0.80 mm)
- . Beam Angle ($\Delta\theta$: 120°)
- . GaN/Al₂O₃ Chip & Long Time Reliability

2) Applications

- . Indoor, Outdoor Display and etc.

2. Absolute Maximum Rating

Parameter	Symbol	Rating	Condition
Operating temperature range	T _{op}	-40 ~ +85 °C	
Storage temperature range	T _{stg}	-40 ~ +100 °C	
Junction Temperature	T _j	110 °C	
Forward current	I _F	150 mA	
Peak Pulsed Forward Current	I _{FP}	300 mA	Duty 1/10 Pulse Width 10 ms
Reverse Voltage	V _R	0.7 ~ 1.2 V	I _R = 5 mA
Thermal resistance, Junction to Solder Point	R _{th, JS}	16.0 °C/W	
Assembly Process Temp.		260 °C, < 10 sec	
ESD		5 kV	HBM

3. Characteristics

Electrical / Optical Characteristics

(T_s : 25 °C)

Item	Symbol	Conditions	Rank	Min.	Typ.	Max.	Unit	
Forward Voltage (*)	V _F	I _F = 65 mA	WA	AZ	2.7	-	2.8	V
				A1	2.8	-	2.9	
				A2	2.9	-	3.0	
				A3	3.0	-	3.1	
				A4	3.1	-	3.2	
Reverse Voltage	V _R	I _R = 5 mA	-	0.7	-	1.2	V	
Color Rendering	R _a	I _F = 65 mA	5	80	-	-	-	
Special CRI	R9	I _F = 65 mA		0	-	-	-	

Luminous Flux

(T_s : 25 °C)

Symbol	Conditions	Model Name	Rank	Min.	Typ.	Max.	Unit	
Φ _v	I _F = 65 mA	SPMWHT541MD5WAP0S0	S0	S1	26.0	-	28.0	lm
				S2	28.0	-	30.0	
				S3	30.0	-	32.0	

Chromaticity Coordinate

(Ts : 25 °C)

Condition	Rank	x				y						
		$I_F = 65 \text{ mA}$	P0	P1	P2	P3	P4	P5	P6	P7	P8	P9
		0.3068	0.3145	0.3135	0.3055	0.3113	0.3187	0.3256	0.3177			
		0.3145	0.3221	0.3216	0.3135	0.3187	0.3261	0.3334	0.3256			
		0.3055	0.3135	0.3126	0.3041	0.3177	0.3256	0.3324	0.3240			
		0.3135	0.3216	0.3210	0.3126	0.3256	0.3334	0.3408	0.3324			
		0.3041	0.3126	0.3117	0.3028	0.3240	0.3324	0.3393	0.3304			
		0.3126	0.3210	0.3205	0.3117	0.3324	0.3408	0.3481	0.3393			
		0.3081	0.3154	0.3145	0.3068	0.3049	0.3119	0.3187	0.3113			
		0.3154	0.3226	0.3221	0.3145	0.3119	0.3188	0.3261	0.3187			
		0.3028	0.3117	0.3107	0.3015	0.3304	0.3393	0.3461	0.3368			
		0.3117	0.3205	0.3200	0.3107	0.3393	0.3481	0.3554	0.3461			

* Tolerance : $V_F: \pm 0.1 \text{ V}$, $I_v: \pm 5 \%$, $x, y: \pm 0.007$, $R_a: \pm 3.0$, $R_9: \pm 6.5$

* Luminous Intensity measuring equipment : CAS140CT

4. Chromaticity Diagram

* CCT Range : 6530K \pm 510K (reference only)

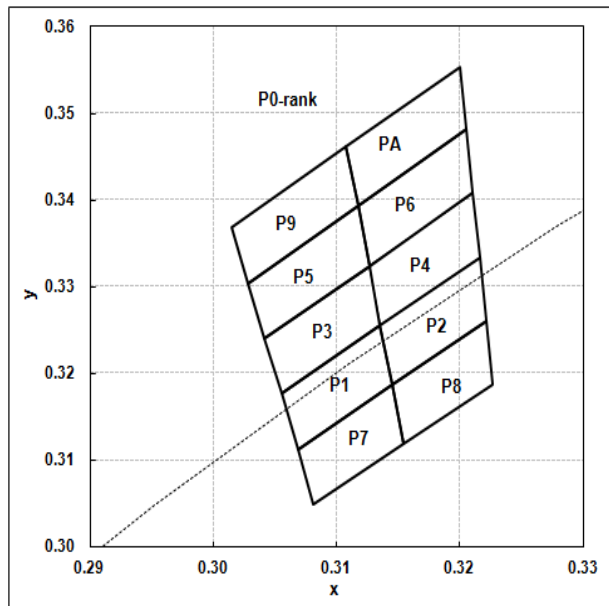
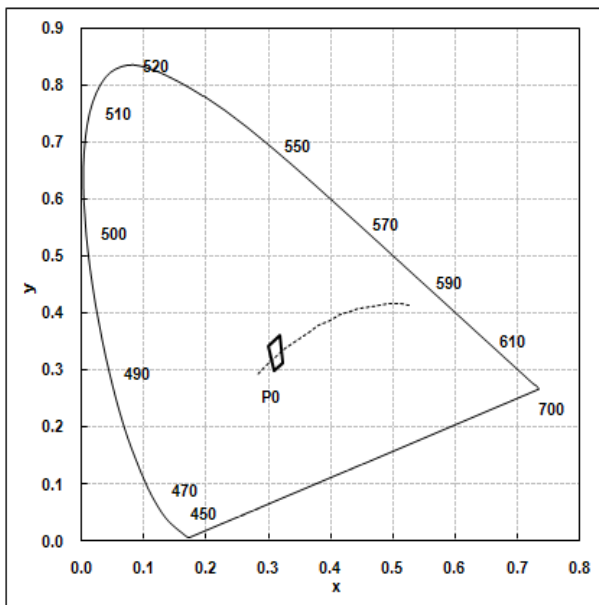

* $P0 = P1 + P2 + P3 + P4 + P5 + P6 + P7 + P8 + P9 + PA$

V_F	CIE	I_v
AZ, A1, A2, A3, A4	P1, P2, P3, P4, P5, P6, P7, P8, P9, PA	S1, S2, S3

* Each reel contains only one of the AZ, A1, A2, A3 or A4 a segment (1/5) of the V_F rank.

* Each P1, P2, P3, P4, P5, P6, P7, P8, P9 or PA a segment (1/10) of the CIE rank.

* Each reel contains only one of the S1, S2 or S3 a segment (1/3) of the I_v rank.

5. Typical Characteristics Graph

* These graphs show typical values.

($T_s : 25\text{ }^\circ\text{C}$)

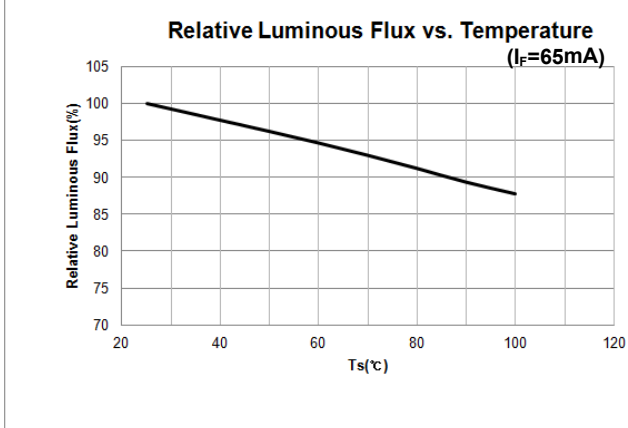
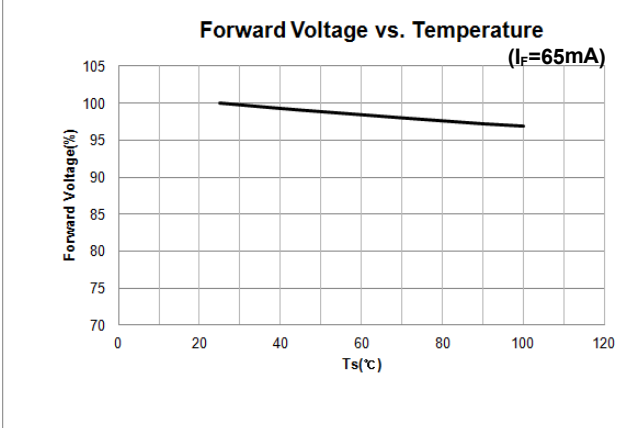
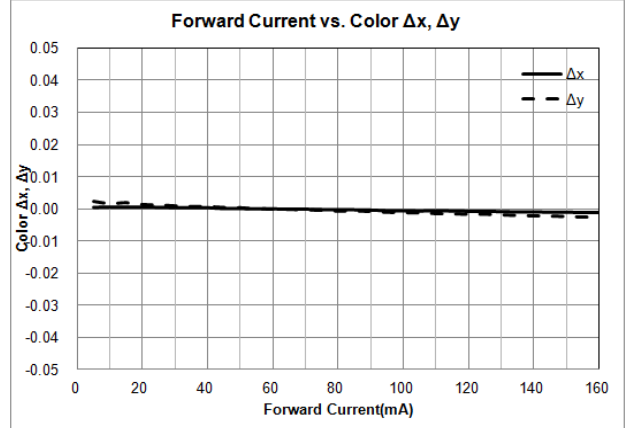
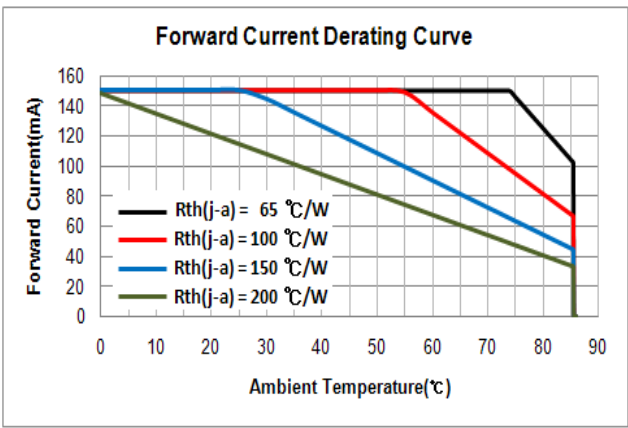
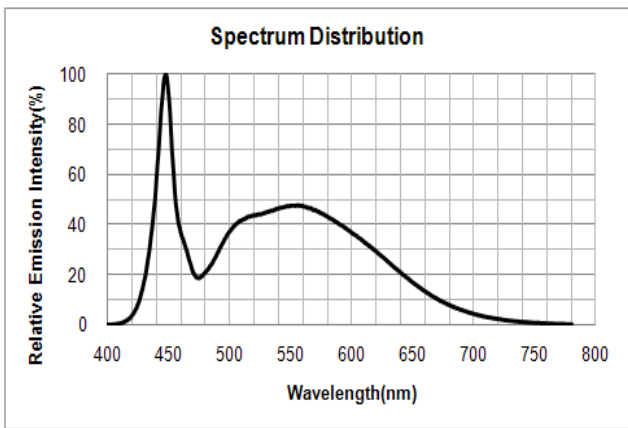
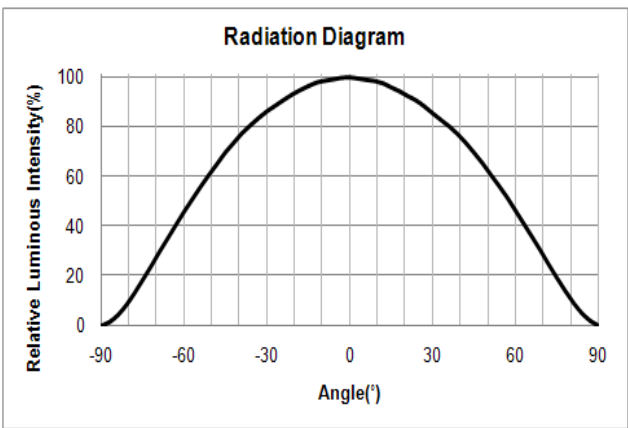
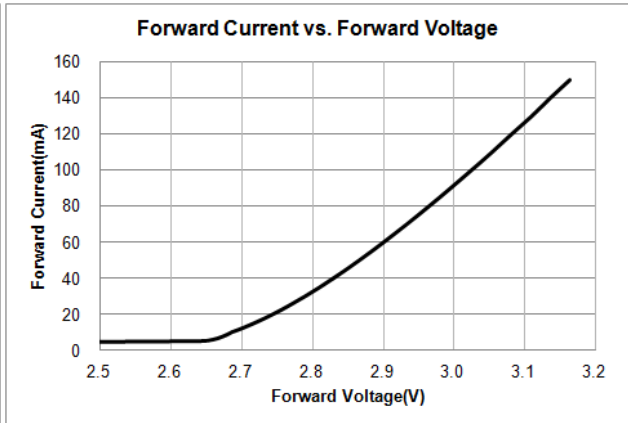
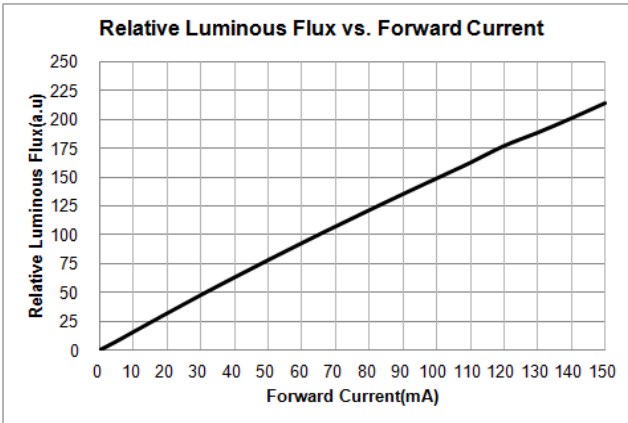

6. LED Package Outline Dimensions

unit:mm

Tolerance:±0.1

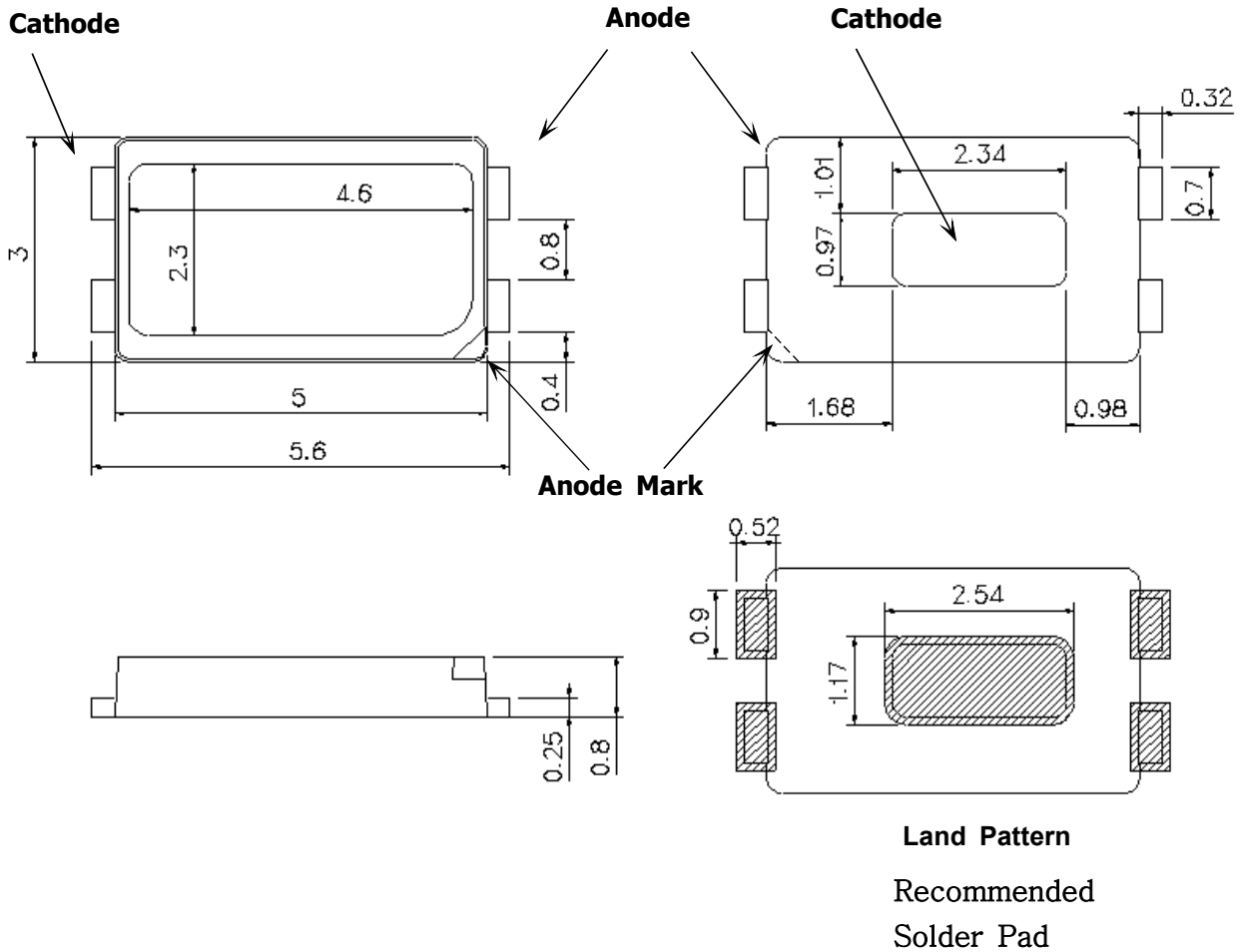

* This LED has built-in ESD protection device(s) connected in parallel to LED chip(s).

Precautions

- ① The pressure on the LEDs will influence to the reliability of the LEDs. Precautions should be taken to avoid the strong pressure on the LEDs. Do not put stress on the LEDs during heating.
- ② Re-soldering should not be done after the LEDs have been soldered. If re-soldering is unavoidable, LED's characteristics should be carefully checked before and after such repair.
- ③ Do not stack assembled PCBs together. Since materials of LEDs is soft, abrasion between two PCB assembled with LED might cause catastrophic failure of the LEDs.

7. Reliability Test Items and Conditions

1) Test Items

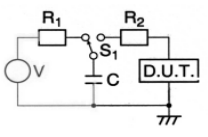
Test Item	Test Conditions	Test Hours/Cycles	Sample No	
MSL Test	125 °C 24hrs drying → 60 °C, 60 %RH 120hrs → 260 °C 10sec 3 cycles	1 cycle	11	
Room Temperature life test	25 °C±3 °C, DC150 mA	1,000 hrs	22	
High Temperature life test	85 °C±3 °C, DC150 mA	1,000 hrs	22	
High Temperature humidity life test	85 °C±3 °C, 85 %±2 %RH, DC150 mA	1,000 hrs	22	
Low Temperature life test	-40 °C±3 °C, DC150 mA	1,000 hrs	22	
Powered Temperature Cycle test	-45°C/20 min ↔ 85°C/20 min, Sweep 100min cycle on/off: each 5 min, DC 150mA	100 cycle	22	
Thermal Shock	-45 °C/15 min ↔ 125 °C/15 min => Reflow 260 °C → Hot plate 180 °C	500 cycle	100	
High Temperature Storage	Ta=120 °C±3 °C	1000 hrs	11	
Low Temperature Storage	Ta=-40 °C±3 °C	1000 hrs	11	
ESD(HBM)		R1:10 MΩ, R2:1.5 kΩ, C:100 pF, V = ±5 kV	5 times	5
ESD(MM)		R1:10 MΩ, R2: 0, C:200 pF, V = ±0.5 kV	5 times	5
Vibration Test	20~2000~20 Hz 200 m/s ² , Sweep 4 min X, Y, Z 3 direction, each 1 cycle	4 cycles	11	
Mechanical Shock Test	1500G, 0.5 ms, 3 shocks each X-Y-Z axis	5 cycles	11	

2) Criteria for Judging the Damage

Item	Symbol	Test Condition	Limit	
			Min	Max
Forward Voltage	V _F	I _F = 65 mA	Init. Value*0.9	Init. Value*1.1
Luminous Intensity	I _v	I _F = 65 mA	Init. Value*0.7	Init. Value*1.1

* USL : Upper Standard Level LSL : Lower Standard Level

8. Solder Conditions

1) Reflow Conditions (Pb Free)

Reflow Frequency : 2 times max.

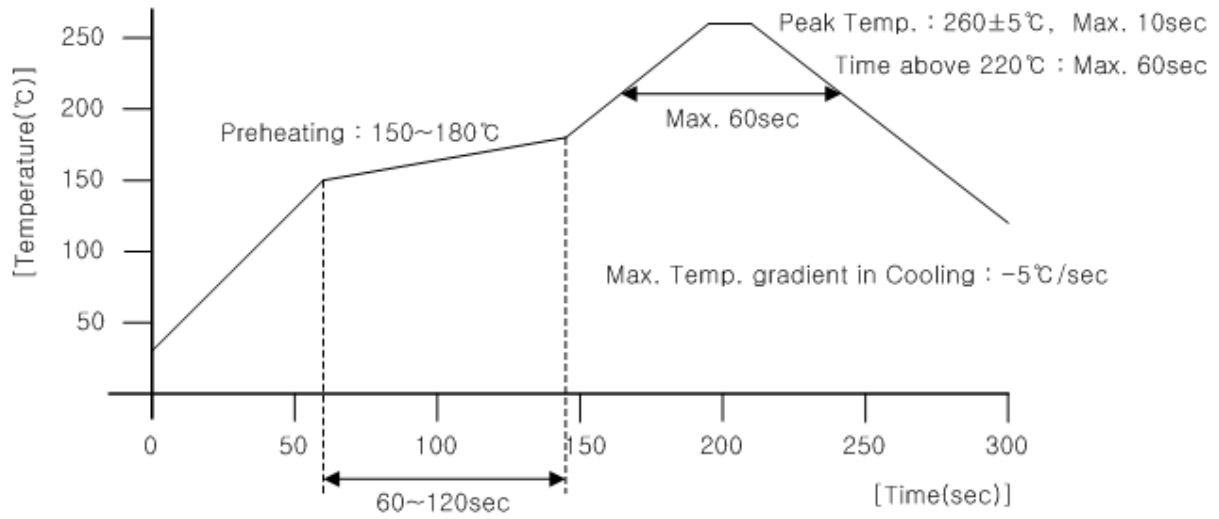

2) For Manual Soldering

Not more than 5 seconds @MAX300 °C, under soldering iron.

9. Taping Dimension

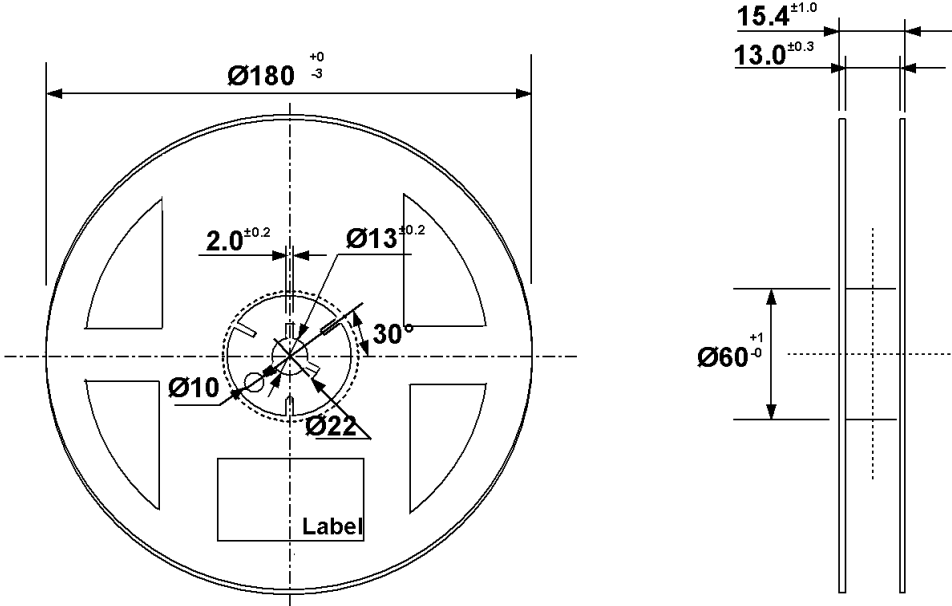
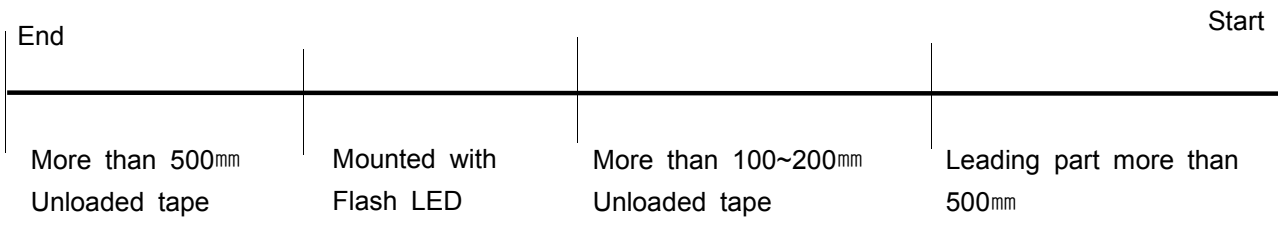
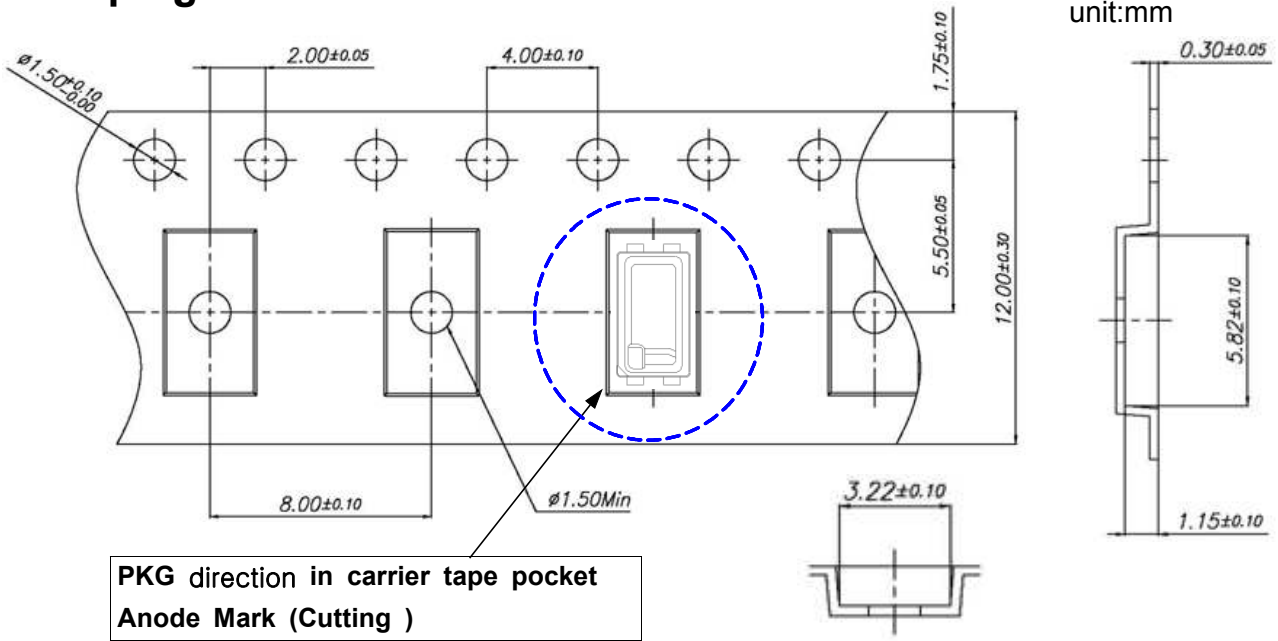

Tolerance ± 0.2 , Unit:mm

- (1) Quantity : The quantity/Reel to be Max. 2,000 pcs, .
- (2) Cumulative Tolerance : Cumulative tolerance/10 pitches to be ± 0.2 mm
- (3) Adhesion Strength of Cover Tape : Adhesion strength to be 0.1-0.7N when the cover tape is turned off from the carrier tape at 10°C angle to be the carrier tape.
- (4) Packaging : P/N, Manufacturing data code no. and quantity to be indicated on a damp proof Package.

10. Label Structure

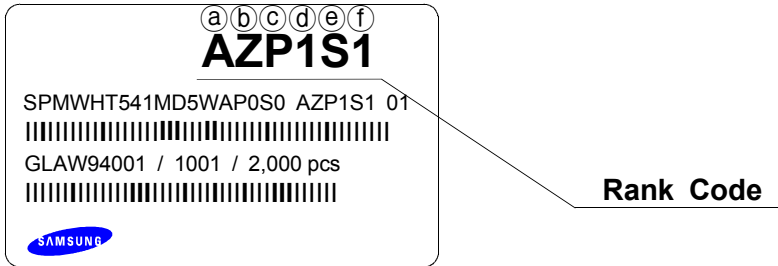

N.B) Denoted rank is the only example.

Rank Code

- ⒶⒷ : Forward Voltage(V_F) Rank (refer to page. 3)
- ⒸⒹ : Chromaticity Coordinate Rank (refer to page. 4)
- ⒺⒻ : Luminous Intensity(cd) Rank (refer to page. 3)

11. Lot Number

The Lot number is composed of the following characters

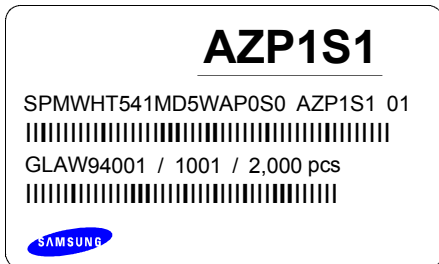

①②③④⑤⑥⑦⑧⑨ / 1ⒶⒷⒸ / 2,000 PCS

- ① : Production Site (S:SAMSUNG ELECTRONICS, G:TIAJIN CHINA)
- ② : L (LED)
- ③ : Product State (A:Normality, B:Bulk, C:First Production, R:Reproduction, S:Sample)
- ④ : Year (V:2011, W:2012, X:2013...)
- ⑤ : Month (1 ~ 9, A, B)
- ⑥ : Day (1 ~ 9, A, B ~ V)
- ⑦⑧⑨ : SAMSUNG ELECTRONICS LED Product number (1 ~ 999)
- ⒶⒷⒸ : Reel Number (1 ~ 999)

12. Reel Packing Structure

Reel

AZP1S1

SPMWHT541MD5WAP0S0 AZP1S1 01
 |||
 GLAW94001 / 1001 / 2,000 pcs
 |||

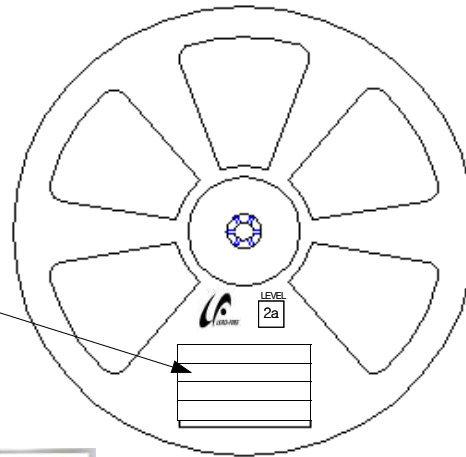

Aluminum Vinyl Bag

AZP1S1

SPMWHT541MD5WAP0S0 AZP1S1 01
 |||
 GLAW94001 / 1001 / 2,000 pcs
 |||

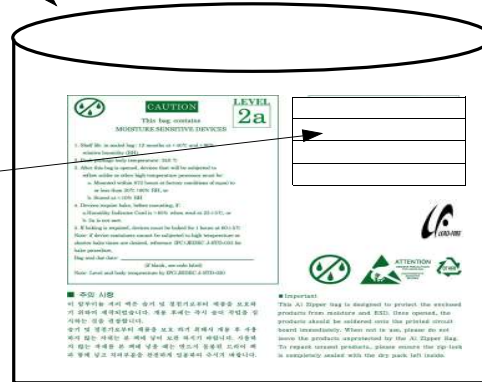

Material : Paper(SW3B(B))

TYPE	SIZE(mm)		
	L	W	H
7inch	245	220	182

① SIDE

AZP1S1

SPMWHT541MD5WAP0S0 AZP1S1 01
 |||
 GLAW94001 / 1001 / 20,000 pcs
 |||

[Box Label]

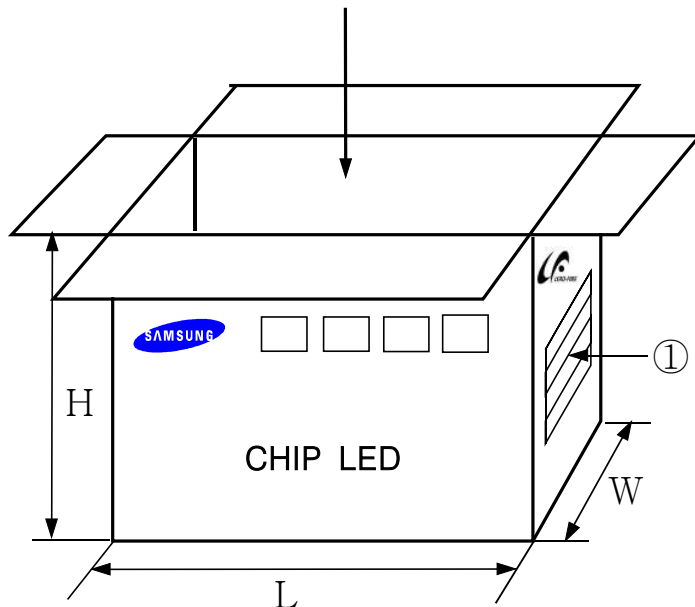

14. Precaution for Use (취급상 주의사항)

- 1) For over-current-proof function, customers are recommended to apply resistors to prevent sudden change of the current caused by slight shift of the voltage.

과전류 방지를 위해 전압의 미세한 이동에 의해 야기되는 전류의 순간 변화를 방지하기 위해 저항 등의 설치를 권장함.

- 2) This device should not be used in any type of fluid such as water, oil, organic solvent, etc. When washing is required, IPA is recommended to use.

제품은 물, 오일, 유기물과 같은 액체 타입에서의 사용은 제한되며, 세정이 필요할 시에는 IPA 사용을 권장함.

- 3) When the LEDs illuminate, operating current should be decided after considering the ambient maximum temperature.

LED의 발광 시, 동작 전류는 주변 최고온도를 고려하여 결정되어야 함.

- 4) LEDs must be stored in a clean environment.

If the LEDs are to be stored for 3 months or more after being shipped from Samsung Electronics, they should be packed by a sealed container with nitrogen gas injected.(Shelf life of sealed bags: 12 months, temp. ~40 °C, ~90 %RH)

LED의 보관은 청정한 환경에서 보존되어야 하며, 만약 삼성전자로부터 공급받는 후 3개월 또는 그 이상 보관이 필요하다면 질소 가스를 동봉한 보존용기에 보관되어야 함. (보존 bag의 수명 : 12 개월, 보존 온도 ~40 °C, 습도 ~90 %RH)

- 5) After storage bag is open, device subjected to soldering, solder reflow, or other high temperature processes must be:

보존 Bag이 개봉된 후에, 납땀이나 reflow등의 높은 온도에 노출되는 제품은 다음의 사항에 부합되어야 함.

- a. Mounted within 672 hours (28 days) at an assembly line with a condition of no more than 30 °C/60 %RH,

a. 제품은 30 °C/60 %RH보다 같거나 낮은 조립조건에서 672시간 (28일)이내에 조립해야 함.

- b. Stored at <10 %RH.

b. 10 % 이하의 상대습도에서 보관되어야 함.

- 6) Repack unused Products with anti-moisture packing, fold to close any opening and then store in a dry place.

사용하지 않은 제품은 방습팩에 넣어 개봉 부위를 닫아서 다시 포장한 후, 건조한 장소에서 보관할 것을 권장함.

7) Devices require baking before mounting, if humidity card reading is $>60\%$ at $23\pm 5\text{ }^\circ\text{C}$.

만약 습도표시카드의 수치가 $23\pm 5\text{ }^\circ\text{C}$ 에서 60% 이상이라면, 제품 실장 전에 baking하여야 함.

8) Devices must be baked for 1 hour at $65\pm 5\text{ }^\circ\text{C}$, if baking is required.

만약 baking이 필요하다면, 제품은 $65\pm 5\text{ }^\circ\text{C}$ 에서 1시간 정도 baking 되어야 함.

9) The LEDs are sensitive to the static electricity and surge. It is recommended to use a wrist band or anti-electrostatic glove when handling the LEDs.

LED는 정전기 및 서지에 민감한 제품이므로, LED 제품을 다룰 시에는 정전기 방지장갑이나 손목밴드를 사용하기를 권장함.

If voltage exceeding the absolute maximum rating is applied to LEDs, it may cause damage or even destruction to LED devices.

만약 절대 허용치를 초과하는 전압이 LED에 가해지면, LED 소자는 파괴되거나 손상될 수 있음.

Damaged LEDs may show some unusual characteristics such as increase in leak current, lowered turn-on voltage, or abnormal lighting of LEDs at low current.

손상된 제품은 누설전류의 증가, Turn on 전압의 저하, 저 전류에서의 점등불량 등의 이상 거동을 보일 수 있음.

10) Risk of Sulfurization (or Tarnishing)

Samsung Electronic's lead frame based package products (such as mid power and HV AC) contain silver (Ag) plated lead frames. Silver may turn black (or tarnish) when exposed to substances such as sulfur, chlorine, or other halogen compounds.

삼성전자의 리드 프레임은 Ag(은)을 도금한 Package 제품입니다.

황(S), 염소(Cl), 또는 다른 할로겐 화합물들에 노출시 Ag(은)은 검정(또는 어두운색)으로 바뀔수 있으니 주의바랍니다.

Sulfurization of the lead frame may result in reduction of lumen output, color shift and an open circuit in some extreme cases.

리드 프레임의 황화(Sulfurization)는 광량 저하, 색좌표 변화 및 심한 경우 회로내의 LED 무등(Open) 불량을 일으킬 수도 있습니다.

Do not store or use such lead frame LED's together with oxidizing substances listed above. The following examples could be sources of such substances: rubber, corrugate paper, solder cream etc.

LED를 아래의 목록으로 만들어진 산화성 물질들과 함께 리드 프레임을 저장하거나 사용하지 마십시오. 황화(Sulfurization)의 근원일 수 있습니다.

: 고무, 일반 종이, 납땜 크림 등

15. Hazard Substance Analysis - SGS



Test Report No. F690101/LF-CTSAYAA12-42150

Issued Date: 2012. 11. 28 Page 1 of 8

To: **SAMSUNG ELECTRONICS CO., LTD.**
San24,Nongseo-dong
Kiheung-gu
Yongin-si
Gyeonggi-do
Korea

The following merchandise was submitted and identified by the client as :

SGS File No.	: AYAA12-42150
Product Name	: MP 5830 Gen2 Cool White
Item No./Part No.	: N/A
Received Date	: 2012. 11. 23
Test Period	: 2012. 11. 26 to 2012. 11. 28
Test Results	: For further details, please refer to following page(s)
Test Performed	: SGS Korea tested the sample(s) selected by applicant with following results.
Test Comments	: By the applicant's specific request, the sampling and testing was performed only for the part indicated in the photo without disassembly.

Timothy Jeon
Jinhee Kim
Cindy Park
Jerry Jung/ Testing Person

SGS Korea Co., Ltd.

Jeff Jang / Chemical Lab Mgr

This document is issued by the Company subject to its General Conditions of Service printed hereon, available on request at www.sgs.com/conditions_of_service.pdf, for electronic format documents, subject to Terms and Conditions for Electronic Documents at www.sgs.com/conditions_of_service_electronic.pdf. Member is deemed to have accepted the terms, conditions and limitations of this document. Any failure of the document to reflect the Company's policy or practice of its operation may constitute a breach of Contractual obligations. The Company is not responsible for any data and/or information obtained from this document and/or any other documents. This document shall be reproduced, stored, transmitted, or otherwise used in any manner without the prior written approval of the Company. Any such reproduction, storage, transmission, or other use may be prohibited by applicable laws. Member is deemed to have accepted the terms, conditions and limitations of this document. Any failure of the document to reflect the Company's policy or practice of its operation may constitute a breach of Contractual obligations. The Company is not responsible for any data and/or information obtained from this document and/or any other documents. This document shall be reproduced, stored, transmitted, or otherwise used in any manner without the prior written approval of the Company. Any such reproduction, storage, transmission, or other use may be prohibited by applicable laws.



Test Report No. F690101/LF-CTSAYAA12-42150

Issued Date: 2012. 11. 28 Page 2 of 6

Sample No. : AYAA12-42150.001
Sample Description : MP 5630 Gen2 Cool White
Item No./Part No. : N/A
Materials : N/A

Heavy Metals

Test Items	Unit	Test Method	MDL	Results
Cadmium (Cd)	mg/kg	With reference to IEC 62321:2008, ICP	0.5	N.D.
Lead (Pb)	mg/kg	With reference to IEC 62321:2008, ICP	5	N.D.
Mercury (Hg)	mg/kg	With reference to IEC 62321:2008, ICP	2	N.D.
Hexavalent Chromium (Cr VI)	mg/kg	With reference to IEC 62321:2008, UV-VIS	1	N.D.
Arsenic (As)	mg/kg	With reference to EPA 3052(1996), US EPA 6010B(1996), ICP	10	N.D.
Antimony (Sb)	mg/kg	With reference to EPA 3052(1996), US EPA 6010B(1996), ICP	10	N.D.
Beryllium (Be)	mg/kg	With reference to EPA 3052(1996), US EPA 6010B(1996), ICP	0.5	N.D.

Flame Retardants-PBBs/PBDEs

Test Items	Unit	Test Method	MDL	Results
Monobromobiphenyl	mg/kg	With reference to IEC 62321:2008, GC-MS	5	N.D.
Dibromobiphenyl	mg/kg	With reference to IEC 62321:2008, GC-MS	5	N.D.
Tribromobiphenyl	mg/kg	With reference to IEC 62321:2008, GC-MS	5	N.D.
Tetrabromobiphenyl	mg/kg	With reference to IEC 62321:2008, GC-MS	5	N.D.
Pentabromobiphenyl	mg/kg	With reference to IEC 62321:2008, GC-MS	5	N.D.
Hexabromobiphenyl	mg/kg	With reference to IEC 62321:2008, GC-MS	5	N.D.
Heptabromobiphenyl	mg/kg	With reference to IEC 62321:2008, GC-MS	5	N.D.
Octabromobiphenyl	mg/kg	With reference to IEC 62321:2008, GC-MS	5	N.D.
Nonabromobiphenyl	mg/kg	With reference to IEC 62321:2008, GC-MS	5	N.D.
Decabromobiphenyl	mg/kg	With reference to IEC 62321:2008, GC-MS	5	N.D.
Monobromodiphenyl ether	mg/kg	With reference to IEC 62321:2008, GC-MS	5	N.D.
Dibromodiphenyl ether	mg/kg	With reference to IEC 62321:2008, GC-MS	5	N.D.
Tribromodiphenyl ether	mg/kg	With reference to IEC 62321:2008, GC-MS	5	N.D.
Tetrabromodiphenyl ether	mg/kg	With reference to IEC 62321:2008, GC-MS	5	N.D.
Pentabromodiphenyl ether	mg/kg	With reference to IEC 62321:2008, GC-MS	5	N.D.
Hexabromodiphenyl ether	mg/kg	With reference to IEC 62321:2008, GC-MS	5	N.D.

NOTE:

- (1) N.D. = Not detected.(<MDL)
- (2) mg/kg = ppm
- (3) MDL = Method Detection Limit
- (4) - = No regulation
- (5) Negative = Undetectable / Positive = Detectable
- (6) ** = Qualitative analysis (No Unit)
- (7) * = Boiling-water-extraction:
 Negative = Absence of CrVI coating
 Positive = Presence of CrVI coating; the detected concentration in boiling-water-extraction solution is equal or greater than 0.02 mg/kg with 50 cm2 sample surface area.

This document is issued by the Company subject to the General Conditions of Service posted on www.sgs.com, available on request or accessible at <http://www.sgs.com/sgsweb/sgsweb.nsf> for electronic format documents, subject to Terms and Conditions for Electronic Documents at <http://www.sgs.com/sgsweb/sgsweb.nsf>. Member is liable to the inclusion of errors, misinterpretation and/or illegible issues due to faults. Any failure to check or to report the errors/misinterpretation/revisions reflects the Company's liability and is not the responsibility of the Client. The Company's sole responsibility is to check and the document does not constitute part of a contract. Any rights, advantages or titles that may be in existence are hereby acknowledged. This document can be reproduced except in full, without prior written approval of the Company. Any unauthorized alteration, copying or distribution of this document in whole and/or in part may be prosecuted. Results listed on this report change subject to retests unless the test report refers only to the samples tested and such samples are retained for 90 days only.

F052 Version5

SGS Korea Co., Ltd.

322, The O valley, 555-9, Hoge-dong, Dongan-gu, Anyang-si, Gyeonggi-do, Korea 431-680
 t +82 (0)31 4606 000 f +82 (0)31 4608 050 <http://www.sgs.com> www.kr.sgs.com

Member of the SGS Group (Société Générale de Surveillance)



Test Report No. F690101/LF-CTSAYAA12-42150

Issued Date: 2012. 11. 28 Page 3 of 6

Sample No. : AYAA12-42150.001
Sample Description : MP 5630 Gen2 Cool White
Item No./Part No. : N/A
Materials : N/A

Flame Retardants-PBBs/PBDEs

Test Items	Unit	Test Method	MDL	Results
Heptabromodiphenyl ether	mg/kg	With reference to IEC 62321:2008, GC-MS	5	N.D.
Octabromodiphenyl ether	mg/kg	With reference to IEC 62321:2008, GC-MS	5	N.D.
Nonabromodiphenyl ether	mg/kg	With reference to IEC 62321:2008, GC-MS	5	N.D.
Decabromodiphenyl ether	mg/kg	With reference to IEC 62321:2008, GC-MS	5	N.D.

Halogen Content

Test Items	Unit	Test Method	MDL	Results
Bromine(Br)	mg/kg	BS EN 14582:2007 , IC	30	N.D.
Chlorine(Cl)	mg/kg	BS EN 14582:2007 , IC	30	N.D.
Fluorine(F)	mg/kg	BS EN 14582:2007 , IC	30	100
Iodine(I)	mg/kg	BS EN 14582:2007 , IC	50	N.D.

Organotin Compounds

Test Items	Unit	Test Method	MDL	Results
Monobutyltin (MBT)	mg/kg	DIN 38407-13 , GC/MS	0.1	N.D.
Dibutyltin (DBT)	mg/kg	DIN 38407-13 , GC/MS	0.1	N.D.
Tributyltin (TBT)	mg/kg	DIN 38407-13 , GC/MS	0.1	N.D.
Bis (tributyltin)oxide (TBTO)	mg/kg	DIN 38407-13 , GC/MS	0.1	N.D.
Tetrabutyltin (TeBT)	mg/kg	DIN 38407-13 , GC/MS	0.1	N.D.
Triphenyltin (TPhT)	mg/kg	DIN 38407-13 , GC/MS	0.1	N.D.
Monooctyltin(MOT)	mg/kg	DIN 38407-13 , GC/MS	0.1	N.D.
Dioctyltin(DOT)	mg/kg	DIN 38407-13 , GC/MS	0.1	N.D.

Other(s)

Test Items	Unit	Test Method	MDL	Results
PFOS (Perfluorooctane Sulfonates-Acid/Metal Salt/Amide)	mg/kg	US EPA 3540C/3550C, LC/MS	1	N.D.

NOTE:

- (1) N.D. = Not detected.(<MDL)
- (2) mg/kg = ppm
- (3) MDL = Method Detection Limit
- (4) - = No regulation
- (5) Negative = Undetectable / Positive = Detectable
- (6) ** = Qualitative analysis (No Unit)
- (7) * = Boiling-water-extraction:
 Negative = Absence of CrVI coating
 Positive = Presence of CrVI coating; the detected concentration in boiling-water-extraction solution is equal or greater than 0.02 mg/kg with 50 cm2 sample surface area.

This document is issued by the Company subject to its General Conditions of Service which are available on request or accessible at <http://www.sgs.com> for electronic format documents, subject to Terms and Conditions for Electronic Documents at www.sgs.com. Member's claims to the inclusion of logos, identification and/or other marks shall remain. Any failure to mark or identify is not the responsibility of the Company. The Company's sole responsibility is to check and the document does not constitute any warranty without liability which is limited to the information contained in this document. The document can be reproduced except in full, without prior written approval of the Company. Any unauthorised alteration, copying or distribution of this document in whole and/or in part may be prosecuted. Documents issued on-site. Unless otherwise indicated, results shown in this report refer only to the samples tested and such samples are retained for 90 days only.



Test Report No. F690101/LF-CTSAYAA12-42150

Issued Date: 2012. 11. 28 Page 5 of 6

Testing Flow Chart for RoHS: Cd/Pb/Hg/Cr⁶⁺ /PBBs&PBDEs Testing

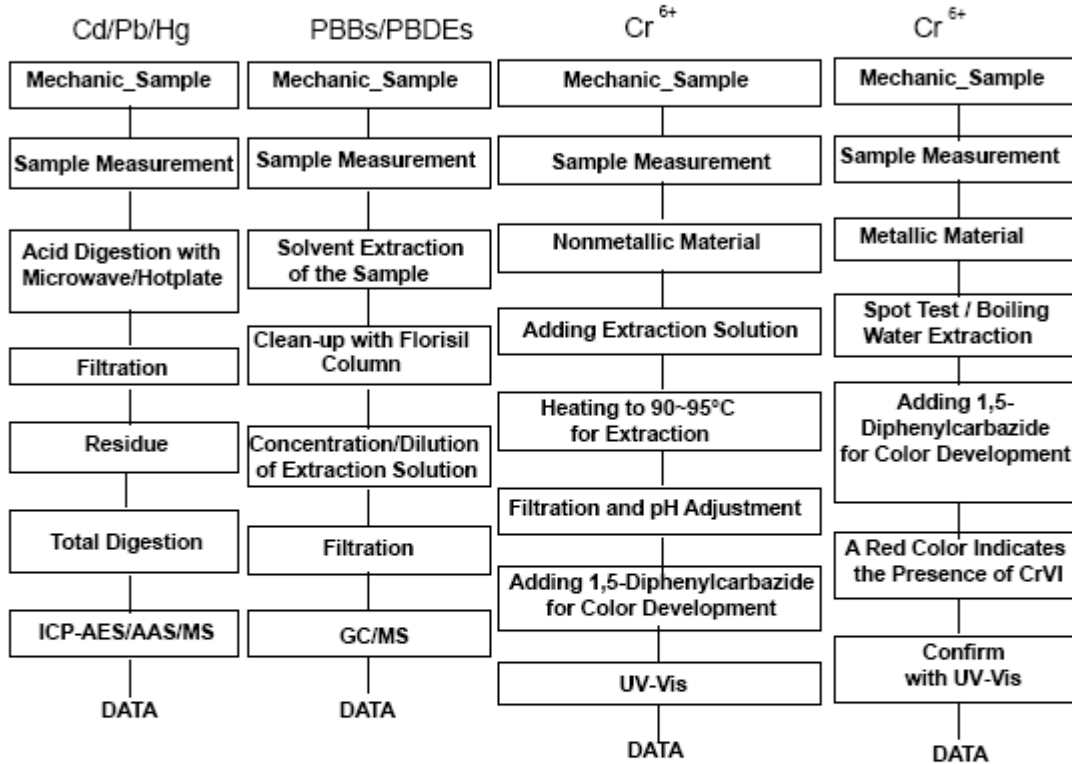

The samples were dissolved totally by pre-conditioning method according to above flow chart for Cd,Pb,Hg.
Section Chief : Gilsae Yi

NOTE:

- (1) N.D. = Not detected.(<MDL)
- (2) mg/kg = ppm
- (3) MDL = Method Detection Limit
- (4) - = No regulation
- (5) Negative = Undetectable / Positive = Detectable
- (6) ** = Qualitative analysis (No Unit)
- (7) * = Boiling-water-extraction:
Negative = Absence of CrVI coating
Positive = Presence of CrVI coating; the detected concentration in boiling-water-extraction solution is equal or greater than 0.02 mg/kg with 50 cm2 sample surface area.

This document is issued by the Company subject to its General Conditions of Service and/or special conditions on request or attachment at <http://www.sgs.com> and/or <http://www.sgs.com/sgsweb> for electronic format documents, subject to Terms and Conditions for Electronic Documents at http://www.sgs.com/sgsweb/electronic_documents. All rights reserved. All other trademarks and/or trade names belong to their respective owners. Any failure of this document to reflect the actual results of the analysis is the responsibility of the client. The Company's liability is limited to the extent of the data and the document does not constitute part of a contract. Any dispute shall be referred to the competent jurisdiction. The document cannot be reproduced except in full, without prior written approval of the Company. Any unauthorized alteration, copying or distribution of this document is prohibited and may be prosecuted. Electronic format documents are valid only if they are signed electronically by the analyst.

F052 Version5

SGS Korea Co.,Ltd.

322, The O valley, 555-0, Hoge-dong, Dongan-gu, Anyang-si, Gyeonggi-do, Korea 431-080
t +82 (0)31 4608 000 f +82 (0)31 4608 050 <http://www.sgs.com> www.kr.sgs.com www.kr.sgs.com/sgsweb

Member of the SGS Group (Société Générale de Surveillance)



Test Report No. F690101/LF-CTSAYAA12-42150

Issued Date: 2012. 11. 28 Page 6 of 6

Flow Chart for Halogen Test

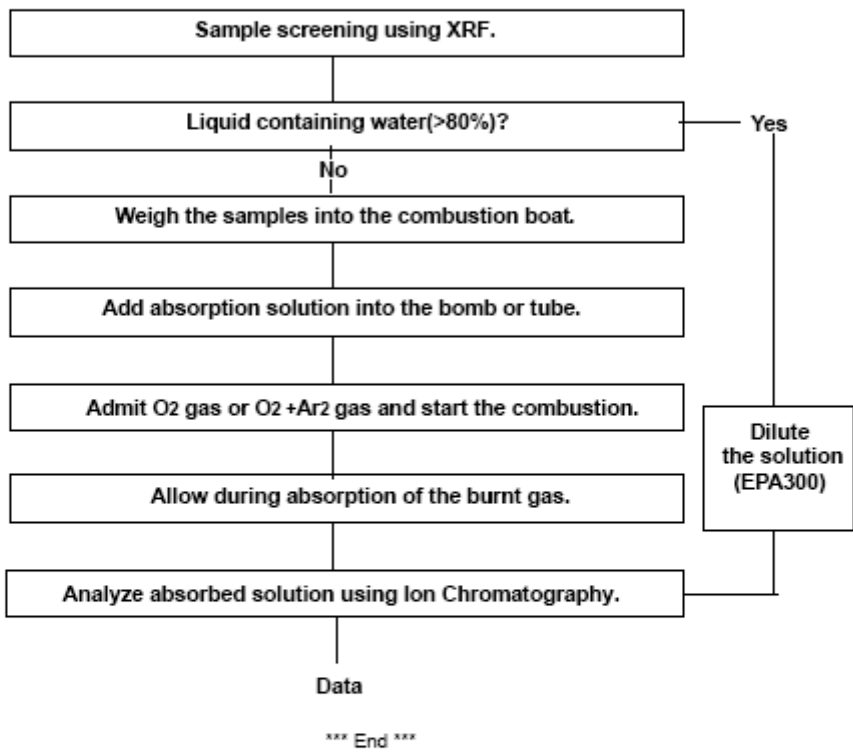

NOTE:

- (1) N.D. = Not detected.(<MDL)
- (2) mg/kg = ppm
- (3) MDL = Method Detection Limit
- (4) - = No regulation
- (5) Negative = Undetectable / Positive = Detectable
- (6) ** = Qualitative analysis (No Unit)
- (7) * = Boiling-water-extraction:
 Negative = Absence of CrVI coating
 Positive = Presence of CrVI coating; the detected concentration in boiling-water-extraction solution is equal or greater than 0.02 mg/kg with 50 cm2 sample surface area.

This document is issued by the Company subject to its General Conditions of Service and/or special conditions on request or otherwise at www.samsungled.com for electronic format documents, subject to Terms and Conditions for Electronic Documents at www.samsungled.com/notice. All rights reserved. This document is for internal use only. Any other use without the prior written consent of the Company is prohibited. The Company's liability is limited to the extent of the document does not constitute any warranty or other rights, obligations or liabilities under the transaction documents. This document cannot be reproduced except in full, without the written approval of the Company. Any unauthorized alteration, copying or distribution of this document in whole or in part may be prosecuted. Documents issued on-line. Unless otherwise indicated, the test report refers only to the sample(s) listed and such sample(s) are related to 30 days only.

F052 Version5

SGS Korea Co.,Ltd.

322, The O valley, 555-9, Hoge-dong, Dongan-gu, Anyang-si, Gyeonggi-do, Korea 431-080
 t +82 (0)31 4606 000 f +82 (0)31 4606 059 <http://www.sgslab.co.kr> www.kr.sgs.com/sgs1010

Member of the SGS Group (Société Générale de Surveillance)

16. Hazard Substance Analysis - SVHC(REACH)



Test Report No. F690101/LF-CTSAYAA12-42149 **Issued Date:** November 30, 2012 **Page 1 of 14**

To: **SAMSUNG ELECTRONICS CO., LTD.**
San 24, Nongseo-dong
Giheung-gu
Yongin-si
Gyeonggi-do
Korea

The following sample(s) was/were submitted and identified by/on behalf of the client as:-

Product Name	: MP 5630 Gen2 Cool White
Item/Part Name	: N/A
SGS File No.	: AYAA12-42149
Received Date	: November 23, 2012
Test Period	: November 26, 2012 ~ November 30, 2012
Test Performed	: SGS Korea tested the sample(s) selected by applicant with following results
Test Requested	: Eighty-four (84) substances in the Candidate List of Substances of Very High Concern (SVHC) for authorization published by European Chemicals Agency (ECHA) on and before June 18, 2012 regarding Regulation (EC) No 1907/2006 concerning the REACH. Fifty-four (54) substances in the Public Consultation List of potential Substances of Very High Concern (SVHC) published by European Chemicals Agency (ECHA) on September 03, 2012 regarding Regulation (EC) No 1907/2006 concerning the REACH.
Test Method	: Please refer to next page(s).
Test Result(s)	: Please refer to next page(s).
Summary	: According to the specified scope and analytical technique, concentrations of all SVHC are <0.1% in the submitted sample(s).

Timothy Jeon
Cindy park
Jinhee Kim
Sophia Kim
/Testing Person

SGS Korea Co., Ltd



Jeff Jang / Chemical Lab Mgr

This document is issued by the Company subject to the General Conditions of Service printed on the back, available on request or accessible at <http://www.sgs.com/Company/Conditions.aspx> and, for clients from the Americas, subject to Terms and Conditions for Electronic Documents at <http://www.sgs.com/Company/Conditions.aspx>. All rights are reserved. The Company is not liable for the accuracy of the information and/or data provided herein. Any liability of the Company is limited to the information provided herein unless the Company's findings are the result of its intentional, only and with the intent of China's provisions. It is the Company's sole responsibility to its Client and this document does not constitute an offer to transact with the Client. All rights and obligations under this document are reserved. This document cannot be reproduced, stored in a retrieval system, or transmitted in any form or by any means, electronic, mechanical, photocopying, recording, or by any information storage and retrieval system, without the prior written permission of the Company. Any unauthorised disclosure, copying, modification or use of this document is prohibited and offenders may be prosecuted to the full extent of the law. (These statements and/or results stated in this test report are only for the sample(s) tested and each sample(s) is/are tested for 95 days only.)

F052 Version 5

SGS Korea Co., Ltd

322, The Ovalley, 255-a, Hogsu-dong, Dongan-gu, Anyang-si, Gyeonggi-do, Korea 431-050
T+82 (0)31 4609 0000 F+82 (0)31 4609 0000 <http://www.sgslab.co.kr> www.kr.sgs.com/greenlab

Member of the SGS Group (Société Générale de Surveillance)



Test Report No. F690101/LF-CTSAYAA12-42149 Issued Date: November 30, 2012 Page 3 of 14

Test Result(s)

Substance Name	CAS number	EC number	Concentration (%)	Reporting Limit (%)	Classification
Alkanes, C10-13, chloro (Short Chain Chlorinated Paraffins)	85535-84-8	287-476-5	N.D.	0.05	PBT
Anthracene	120-12-7	204-371-1	N.D.	0.05	PBT
Benzyl butyl phthalate (BBP)	85-68-7	201-622-7	N.D.	0.05	Toxic for Reproduction
Bis(2-ethylhexyl)phthalate (DEHP)	117-81-7	204-211-0	N.D.	0.05	Toxic for Reproduction
Bis(tributyltin)oxide	56-35-9	200-268-0	N.D.	0.05	PBT
Cobalt dichloride*	7646-79-9	231-589-4	N.D.	0.005	Carcinogen Toxic for Reproduction
4,4-Diaminodiphenylmethane	101-77-9	202-974-4	N.D.	0.05	Carcinogen
Diarsenic pentaoxide*	1303-28-2	215-116-9	N.D.	0.005	Carcinogen
Diarsenic trioxide*	1327-53-3	215-481-4	N.D.	0.005	Carcinogen
Dibutyl phthalate (DBP)	84-74-2	201-557-4	N.D.	0.05	Toxic for Reproduction
Hexabromocyclododecane (HBCDD) and all major diastereoisomers identified (α -HBCDD, β -HBCDD, γ -HBCDD)	25637-99-4and 3194-55-6 (134237-51-7, 134237-50-6, 134237-52-8)	247-148-4 and 221-695-9	N.D.	0.05	PBT
Lead hydrogen arsenate*	7784-40-9	232-064-2	N.D.	0.005	Carcinogen Toxic for Reproduction
Sodium dichromate (Sodium dichromate, dehydrate)	10588-01-9 (7789-12-0)	234-190-3	N.D.	0.005	Carcinogen Mutagen Toxic for Reproduction
5-tert-butyl-2,4,6-trinitro-m-xylene (musk xylene)	81-15-2	201-329-4	N.D.	0.05	vPvB
Triethyl arsenate*	15606-95-8	427-700-2	N.D.	0.005	Carcinogen

This document is issued by the Company subject to the General Conditions of Service printed hereon, available on request or accessible at http://www.sgs.com/conditions_of_service and, for clients' terms documents, subject to Terms and Conditions for Electronic Documents at http://www.sgs.com/conditions_of_service. Attention is drawn to the limitation of liability, indemnification and jurisdiction clause defined therein. Any holder of this document is advised that electronic version of this document is available for use only and not for printing or other reproduction. It is the Company's sole responsibility to its Client and this document does not constitute advice or a substitute for consulting all their rights and obligations under the applicable law. This document cannot be reproduced, stored in a retrieval system, or transmitted in any form or by any means, electronic, mechanical, photocopying, recording, or otherwise, without the prior written approval of the Company. Any unauthorized alteration, copying or distribution of this document is prohibited and offenders may be prosecuted to the fullest extent of the law. Unless otherwise stated, the results shown in this test report have only the analytical (tested and such sample) are related for 95 days only.

F052 Version 5

SGS Korea Co., Ltd.

322, The Ovalley, 255-9, Hogeje-dong, Dongan-gu, Anyang-si, Gyeonggi-do, Korea 431-550
T+82 (0)31 4508 000 F+82 (0)31 4508 050 <http://www.sgslab.co.kr> www.kr.sgs.com sgs@sgs.com

Member of the SGS Group (Société Générale de Surveillance)



Test Report No. F690101/LF-CTSAYAA12-42149 Issued Date: November 30, 2012 Page 6 of 14

Substance Name	CAS number	EC number	Concentration (%)	Reporting Limit (%)	Classification
Cobalt(II) sulphate*	10124-43-3	233-334-2	N.D.	0.005	Carcinogen Toxic for Reproduction
Cobalt(II) dinitrate*	10141-05-6	233-402-1	N.D.	0.005	Carcinogen Toxic for Reproduction
Cobalt(II) carbonate*	513-79-1	208-169-4	N.D.	0.005	Carcinogen Toxic for Reproduction
Cobalt(II) diacetate*	71-48-7	200-755-8	N.D.	0.005	Carcinogen Toxic for Reproduction
2-Methoxyethanol	109-86-4	203-713-7	N.D.	0.05	Toxic for Reproduction
2-Ethoxyethanol	110-80-5	203-804-1	N.D.	0.05	Toxic for Reproduction
Chromium trioxide*	1333-82-0	215-607-8	N.D.	0.005	Carcinogen Mutagen
Acids generated from chromium trioxide and their oligomers:					
Chromic acid	7738-94-5	231-801-5	N.D.	0.005	Carcinogen
Dichromic acid	13530-68-2	236-881-5			
Oligomers of chromic acid and dichromic acid*	-	-			
1-methyl-2-pyrrolidone	872-50-4	212-828-1	N.D.	0.05	Toxic for Reproduction
2-ethoxyethyl acetate	111-15-9	203-839-2	N.D.	0.05	Toxic for Reproduction
1,2-benzenedicarboxylic acid, di-C6-8-branched alkyl esters, C7-rich	71888-89-6	276-158-1	N.D.	0.05	Toxic for Reproduction
1,2-benzenedicarboxylic acid, di-C7-11-branched and linear alkyl esters	68515-42-4	271-084-6	N.D.	0.05	Toxic for Reproduction
1,2,3-trichloropropane	96-18-4	202-486-1	N.D.	0.05	Carcinogen Toxic for Reproduction
Hydrazine	7803-57-8 302-01-2	206-114-9	N.D.	0.05	Carcinogen
Strontium chromate*	7789-06-2	232-142-6	N.D.	0.005	Carcinogen

This document is issued by the Company subject to its General Conditions of Service printed separately, available on request or accessible at http://www.sgs.com/conditions_of_service and its clients Terms of Service, subject to Terms and Conditions for Electronic Documents at http://www.sgs.com/conditions_of_service. All services are subject to the limitations of liability, indemnification and jurisdiction clauses defined therein. Any holder of this document is advised that the original version of the document defines the Company's liability and the use of its information only and not the liability of the Client. The Company's sole responsibility is to its Client and this document does not assume any liability or responsibility for exceeding all their rights and obligations under the applicable documents. This document cannot be reproduced, stored in full, without prior written approval of the Company. Any unauthorized alteration, forgery or falsification of the content or appearance of this document is prohibited and offenders may be prosecuted to the fullest extent of the law. Unless otherwise stated, this results sheet is the intellectual property of the company(ies) listed and such sample(s) are retained by SGS S.p.A.

F052 Version 5

SGS Korea Co., Ltd.

322, The Ovalley, 255-9, Hogeje-dong, Dongan-gu, Anyang-si, Gyeonggi-do, Korea 431-050
 t+82 (0)31 4508 000 f+82 (0)31 4508 050 <http://www.sgslab.co.kr> www.kr.sgs.com/guestlab

Member of the SGS Group (Société Générale de Surveillance)



Test Report No. F690101/LF-CTSAYAA12-42149 Issued Date: November 30, 2012 Page 7 of 14

Substance Name	CAS number	EC number	Concentration (%)	Reporting Limit (%)	Classification
1,2-Dichloroethane	107-06-2	203-458-1	N.D.	0.05	Carcinogenic
2,2'-dichloro-4,4'-methylenedianiline (MOCA)	101-14-4	202-918-9	N.D.	0.05	Carcinogenic
2-Methoxyaniline o-Anisidine	90-04-0	201-963-1	N.D.	0.05	Carcinogenic
4-(1,1,3,3-tetramethylbutyl)phenol, (4-tert-Octylphenol)	140-66-9	205-426-2	N.D.	0.05	Equivalent level of concern having probable serious effects to the environment
Aluminosilicate Refractory Ceramic Fibres* (RCF)	650-017-00-8 (Index no.)	-	N.D.	0.005	Carcinogenic
Arsenic acid*	7778-39-4	231-901-9	N.D.	0.005	Carcinogenic
Bis(2-methoxyethyl) ether	111-96-6	203-924-4	N.D.	0.05	Toxic for reproduction
Bis(2-methoxyethyl) phthalate	117-82-8	204-212-6-	N.D.	0.05	Toxic for reproduction
Calcium arsenate*	7778-44-1	231-904-5	N.D.	0.005	Carcinogenic
Dichromium tris(chromate)*	24613-89-6	246-356-2	N.D.	0.005	Carcinogenic
Formaldehyde, oligomeric reaction products with aniline (technical MDA)	25214-70-4	500-036-1	N.D.	0.05	Carcinogenic
Lead diazide*	13424-46-9	236-542-1	N.D.	0.005	Toxic for reproduction
Lead dipicrate*	6477-64-1	229-335-2	N.D.	0.005	Toxic for reproduction
Lead styphnate*	15245-44-0	239-290-2	N.D.	0.005	Toxic for reproduction
N,N-dimethylacetamide (DMAC)	127-19-5	204-826-4	N.D.	0.05	Toxic for reproduction
Pentazinc chromate octahydroxide*	49663-84-5	256-418-0	N.D.	0.005	Carcinogenic
Phenolphthalein	77-09-8	201-004-7	N.D.	0.05	Carcinogenic
Potassium hydroxyoctaoxodizincatedichromate*	11103-86-9	234-329-8	N.D.	0.005	Carcinogenic
Trilead diarsenate*	3687-31-8	222-979-5	N.D.	0.005	Carcinogenic Toxic for reproduction
Zirconia Aluminosilicate Refractory Ceramic Fibres (Zr-RCF)*	650-017-00-8 (Index no.)	-	N.D.	0.005	Carcinogenic

This document is issued by the Company subject to its General Conditions of Service printed hereon, available on request or accessible at http://www.sgs.com/conditions_of_service and, for clients' Terms of Service, subject to Terms and Conditions for Electronic Documents at http://www.sgs.com/conditions_of_service. All services are subject to the limitations of liability, indemnification and jurisdiction clauses defined therein. Any holder of this document is advised that the original version of the document, unless the Company's logo is visible, is its own version only and not the version of the Client. The Company's sole responsibility is to the Client and this document does not constitute advice or a substitute for consulting all their rights and obligations under the relevant documents. This document cannot be reproduced, stored in a retrieval system, or transmitted, in any form or by any means, electronic, mechanical, photocopying, recording, or by any information storage and retrieval system, without the prior written approval of the Company. Any unauthorized alteration, copying or distribution of this document is prohibited and offenders may be prosecuted to the fullest extent of the law. Unless otherwise stated, this report is only for the named client and such sample(s) are marked for 90 days only.

F052 Version 5

SGS Korea Co., Ltd.

322, The Ovalry, 255-9, Hoge-dong, Dongan-gu, Anyang-si, Gyeonggi-do, Korea 431-550
 t+82 (0)31 4508 000 f+82 (0)31 4508 050 <http://www.sgslab.co.kr> www.kr.sgs.com/guestlab

Member of the SGS Group (Société Générale de Surveillance)



Test Report No. F690101/LF-CTSAYAA12-42149 **Issued Date:** November 30, 2012 **Page 9 of 14**

The potential Substances

Substance Name	CAS number	EC number	Concentration (%)	Reporting Limit (%)	Classification
Bis(pentabromophenyl) ether (DecaBDE)	1163-19-5	214-604-9	N.D.	0.05	PBT vPvB
Pentacosafuorotridecanoic acid	72629-94-8	276-745-2	N.D.	0.05	vPvB
Tricosafuorododecanoic acid	307-55-1	206-203-2	N.D.	0.05	vPvB
Henicosafuoroundecanoic acid	2058-94-8	218-165-4	N.D.	0.05	vPvB
Heptacosafuorotetradecanoic acid	376-06-7	206-803-4	N.D.	0.05	vPvB
4-(1,1,3,3-tetramethylbutyl)phenol, ethoxylated - covering well-defined substances and UVCB substances, polymers and homologues	-	-	N.D.	0.05	Equivalent level of concern - probable serious effects on the environment
4-Nonylphenol, branched and linear - substances with a linear and/or branched alkyl chain with a carbon number of 9 covalently bound in position 4 to phenol, covering also UVCB- and well-defined substances which include any of the individual isomers or a combination thereof	-	-	N.D.	0.05	Equivalent level of concern - probable serious effects on the environment
Diazene-1,2-dicarboxamide (C,C'-azodi(formamide))	123-77-3	204-650-8	N.D.	0.05	Equivalent level of concern - probable serious effects on human health
Cyclohexane-1,2-dicarboxylic anhydride (Hexahydrophthalic anhydride - HHPA)	85-42-7	201-604-9	N.D.	0.05	Equivalent level of concern - probable serious effects on human health

This document is issued by the Company subject to the General Conditions of Service printed hereon, available on request or accessible at <http://www.sgs.com/sgsweb/Content/SGS%20General%20Conditions%20of%20Service.pdf> and for clients from documents subject to Terms and Conditions for Electronic Documents at <http://www.sgs.com/sgsweb/Content/SGS%20Terms%20and%20Conditions%20for%20Electronic%20Documents.pdf>. The Company's sole responsibility is to its Client and this document does not constitute advice or guarantee in respect of their rights and obligations under the applicable documents. This document cannot be reproduced or used in full without prior written approval of the Company. Any unauthorized disclosure, copying, or modification of the content or appearance of this document is prohibited and if detected may be prosecuted to the fullest extent of the law. Other observations of this result shown in this report may refer only to the sample(s) tested and such sample(s) are retained for 90 days only.

F062 Version 5

SGS Korea Co., Ltd.

322, The Ovalley, 555-9, Hoga-dong, Dongan-gu, Anyang-si, Gyeonggi-do, Korea 431-850
t: +82 (0)31 4509 900 f: +82 (0)31 4509 950 <http://www.sgslab.co.kr/www.kr.sgs.com/sgsweb>

Member of the SGS Group (Société Générale de Surveillance)



Test Report No. F690101/LF-CTSAYAA12-42149 Issued Date: November 30, 2012 Page 11 of 14

Substance Name	CAS number	EC number	Concentration (%)	Reporting Limit (%)	Classification
Dioxobis(stearato)trilead*	12578-12-0	235-702-8	N.D.	0.005	Toxic for reproduction
Fatty acids, C16-18, lead salts*	91031-62-8	292-966-7	N.D.	0.005	Toxic for reproduction
Lead bis(tetrafluoroborate)*	13814-96-5	237-486-0	N.D.	0.005	Toxic for reproduction
Lead cyanamidate*	20837-86-9	244-073-9	N.D.	0.005	Toxic for reproduction
Lead dinitrate*	10099-74-8	233-245-9	N.D.	0.005	Toxic for reproduction
Lead oxide (lead monoxide)*	1317-36-8	215-267-0	N.D.	0.005	Toxic for reproduction
Lead tetroxide (orange lead)*	1314-41-6	215-235-6	N.D.	0.005	Toxic for reproduction
Lead titanium trioxide*	12060-00-3	235-038-9	N.D.	0.005	Toxic for reproduction
Lead Titanium Zirconium Oxide*	12626-81-2	235-727-4	N.D.	0.005	Toxic for reproduction
Pentalead tetraoxide sulphate*	12065-90-6	235-067-7	N.D.	0.005	Toxic for reproduction
Pyrochlore, antimony lead yellow*	8012-00-8	232-382-1	N.D.	0.005	Toxic for reproduction
Silicic acid, barium salt, lead-doped*	68784-75-8	272-271-5	N.D.	0.005	Toxic for reproduction
Silicic acid, lead salt*	11120-22-2	234-363-3	N.D.	0.005	Toxic for reproduction
Sulfurous acid, lead salt, dibasic*	62229-08-7	263-467-1	N.D.	0.005	Toxic for reproduction
Tetraethyllead*	78-00-2	201-075-4	N.D.	0.005	Toxic for reproduction
Tetralead trioxide sulphate*	12202-17-4	235-380-9	N.D.	0.005	Toxic for reproduction

This document is issued by the Company subject to the General Conditions of Service printed hereon, available as requested or accessible at <http://www.sgs.com/~/media/SGS/ServiceConditions/ServiceConditions.pdf> or directly from the company subject to Terms and Conditions for Electronic Documents at <http://www.sgs.com/~/media/SGS/ServiceConditions/ServiceConditions.pdf>. Attention is drawn to the limitation of liability, indemnification and jurisdiction clauses defined therein. Any value of this document is subject to the original or certified document unless the Company's knowledge of the true state of its information only and not the contents of Client's materials. It is the Company's sole responsibility to its Client and this document does not assume liability or is released from according to their rights and obligations under the applicable documents. This document cannot be reproduced except in full without prior written consent of the Company. Any unauthorized alteration, forgery or falsification of the content or appearance of this document is unlawful and offenders may be prosecuted to the fullest extent of the law. Unless otherwise stated, the results shown in this test report are only for the sample(s) tested and such sample(s) are retained for 90 days only.

F052 Version 5

SGS Korea Co., Ltd.

322, The Ovalley, 255-a, Hogeje-dong, Dongan-gu, Anyang-si, Gyeonggi-do, Korea 431-050
t+82 (0)31 4608 000 f+82 (0)31 4608 050 <http://www.sgs.co.kr> www.kr.sgs.com/guestlab

Member of the SGS Group (Société Générale de Surveillance)



Test Report No. F690101/LF-CTSAYAA12-42149 Issued Date: November 30, 2012 Page 12 of 14

Substance Name	CAS number	EC number	Concentration (%)	Reporting Limit (%)	Classification
Trilead dioxide phosphonate*	12141-20-7	235-252-2	N.D.	0.005	Toxic for reproduction
Furan	110-00-9	203-727-3	N.D.	0.05	Carcinogenic
Propylene oxide; 1,2-epoxypropane; methyloxirane	75-56-9	200-879-2	N.D.	0.05	Carcinogenic Mutagenic
Diethyl sulphate	64-67-5	200-589-6	N.D.	0.05	Carcinogenic Mutagenic
Dimethyl sulphate	77-78-1	201-058-1	N.D.	0.05	Carcinogenic
3-ethyl-2-methyl-2-(3-methylbutyl)-1,3-oxazolidine	143860-04-2	421-150-7	N.D.	0.05	Toxic for reproduction
Dinoseb	88-85-7	201-861-7	N.D.	0.05	Toxic for reproduction
4,4'-methylenedi-o-toluidine	838-88-0	212-658-8	N.D.	0.05	Carcinogenic
4,4'-oxydianiline and its salts	101-80-4	202-977-0	N.D.	0.05	Carcinogenic Mutagenic
4-Aminoazobenzene; 4-Phenylazoaniline	60-09-3	200-453-6	N.D.	0.05	Carcinogenic
4-methyl-m-phenylenediamine (2,4-toluene-diamine)	95-80-7	202-453-1	N.D.	0.05	Carcinogenic
6-methoxy-m-toluidine (p-cresidine)	120-71-8	204-419-1	N.D.	0.05	Carcinogenic
Biphenyl-4-ylamine	92-67-1	202-177-1	N.D.	0.05	Carcinogenic
o-aminoazotoluene	97-56-3	202-591-2	N.D.	0.05	Carcinogenic
o-Toluidine; 2-Aminotoluene	95-53-4	202-429-0	N.D.	0.05	Carcinogenic
N-methylacetamide	79-16-3	201-182-6	N.D.	0.05	Toxic for reproduction
1-bromopropane; n-propyl bromide	106-94-5	203-445-0	N.D.	0.05	Toxic for reproduction

This document is issued by the Company subject to the General Conditions of Service printed on each analytical report or available at <http://www.sgs.com/ServiceConditions.html> or directly from the Company. It is intended for the use of the client only and does not constitute a contract. The Company's sole responsibility is to the Client and this document does not constitute a guarantee from us regarding all our rights and obligations under the applicable laws. This document cannot be reproduced except in full without prior written consent of the Company. Any unauthorized copying, posting, or distribution of this document is prohibited and offenders may be prosecuted to the fullest extent of the law. Unless otherwise stated, the results shown in this test report are only for the sample(s) tested and such sample(s) are marked as 'S' in the report.

F052 Version 5

SGS Korea Co., Ltd.

322, The Ovalley, 255-a, Hoge-dong, Dongan-gu, Anyang-si, Gyeonggi-do, Korea 431-050
t+82 (0)31 4698 000 f+82 (0)31 4698 050 <http://www.sgs.co.kr> www.kr.sgs.com/guestlab

Member of the SGS Group (Société Générale de Surveillance)



Test Report No. F690101/LF-CTSAYAA12-42149 Issued Date: November 30, 2012 Page 14 of 14

Appendix A

Classification	Definition under 67/548/EEC and Regulation (EC) No 1907/2006
Carcinogen Category 1:	<u>Substances known to be carcinogenic to man.</u> There is sufficient evidence to establish a causal association between human exposure to a substance and the development of cancer.
Carcinogen Category 2:	<u>Substances which should be regarded as if they are carcinogenic to man.</u> There is sufficient evidence to provide a strong presumption that human exposure to a substance may result in the development of cancer. Generally on the basis of: - appropriate long-term animal studies - other relevant information.
Mutagen Category 1:	<u>Substances known to be mutagenic to man.</u> There is sufficient evidence to establish a causal association between human exposure to a substance and heritable genetic damage.
Mutagen Category 2:	<u>Substances which should be regarded as if they are mutagenic to man.</u> There is sufficient evidence to provide a strong presumption that human exposure to the substance may result in the development of heritable genetic damage, generally on the basis of: - appropriate animal studies, - other relevant information.
Toxic to Reproduction Category 1:	<u>Substances known to impair fertility in humans.</u> There is sufficient evidence to establish a causal relationship between human exposure to the substance and impaired fertility. <u>Substances known to cause developmental toxicity in humans.</u> There is sufficient evidence to establish a causal relationship between human exposure to the substance and subsequent developmental toxic effects in the progeny.
Toxic to Reproduction Category 2:	<u>Substances which should be regarded as if they impair fertility in humans.</u> There is sufficient evidence to provide a strong presumption that human exposure to the substance may result in impaired fertility on the basis of: - clear evidence in animal studies of impaired fertility in the absence of toxic effects, or, evidence of impaired fertility occurring at around the same dose levels as other toxic effects but which is not a secondary nonspecific consequence of the other toxic effects, - other relevant information. <u>Substances which should be regarded as if they cause developmental toxicity to humans.</u> There is sufficient evidence to provide a strong presumption that human exposure to the substance may result in developmental toxicity, generally on the basis of: - clear results in appropriate animal studies where effects have been observed in the absence of signs of marked maternal toxicity, or at around the same dose levels as other toxic effects but which are not a secondary non-specific consequence of the other toxic effects, - other relevant information.
PBT & vPvB:	Substances which are persistent, bioaccumulative and toxic (PBT) or very persistent and very bioaccumulative (vPvB) pose a particular challenge to the chemicals safety management. For these substances a "safe" concentration in the environment cannot be established with sufficient reliability.

This document is issued by the Client subject to the General Conditions of Service attached herewith, available on request or accessible at http://www.sgs.com/conditions_of_service and for details please refer to the Terms and Conditions for Electronic Documents at www.sgs.com/conditions_of_service. In addition the Client hereby acknowledges and warrants that the information contained herein is true and correct to the best of their knowledge and belief and that they warrant the accuracy and reliability of the information provided to SGS. The Client's sole responsibility is to the Client and the information does not constitute an assurance or warranty from SGS regarding all their rights and obligations under the contract documents. This document cannot be reproduced except in full without prior written approval of the Client. Any use or distribution of this document is subject to the Client's prior written approval. The Client's attention is drawn to the fact that the Client's use of this document is subject to the Client's prior written approval.

F062 Version 5

SGS Korea Co., Ltd.

322, The Ovality, 255-9, Hoga-dong, Dongan-gu, Anyang-si, Gyeonggi-do, Korea 431-350
t+82 (0)31 4508 0201-432 (0)31 4508 0202 <http://www.sgslab.co.kr> www.kr.sgs.com gsnlab@sgs.com

Member of the SGS Group (Société Générale de Surveillance)

