

SMD ■ MID POWER LED

62-217B/XK2C-SXXXXXXXXXXZ15/2T



Features

- PLCC-4 Package
- Top view white LED
- High luminous flux output
- High current capability
- Wide viewing angle
- Pb-free
- RoHS compliant
- ANSI Binning

Description

The Everlight 0.5W 62-217B package has high efficacy, high CRI, low power consumption, wide viewing angle and a compact form factor. These features make this package an ideal LED for all lighting application.

Applications

- Decorative and Entertainment Lighting
- Light pipe application
- Indicator and backlight in office and family equipment
- General use

Product Number Explanation

62-217B / XK 2 C - S XX XX XX XX XX Z15/ 2T



Table of Color Rendering Index

| Symbol | Description |
|--------|----------------|
| M | CRI(Min.) : 60 |
| N | CRI(Min.) : 65 |
| L | CRI(Min.) : 70 |
| Q | CRI(Min.) : 75 |
| K | CRI(Min.) : 80 |
| H | CRI(Min.) : 90 |

Notes:

Tolerance of Color Rendering Index: ±2

Table of Forward Current Index

| Symbol | Description |
|--------|-----------------------|
| Z15 | I _F :150mA |

Example:

62-217B/QK2C-S5757R1R3B42Z15/2T

| | |
|----------------|-----------|
| CRI | 75(Min.) |
| CCT | 5700K |
| Flux | 50~65lm |
| V _F | 2.8V~3.5V |
| I _F | 150mA |

Mass Production list

| Product | CRI Min. | CCT(K) | Φ(lm) Min. | Φ(lm) Typ. | Φ(lm) Max. |
|---------------------------------|----------|--------|------------|------------|------------|
| 62-217B/QK2C-S6565R1R3B42Z15/2T | 75 | 6500K | 50 | 55 | 65 |
| 62-217B/QK2C-S5757QAR1B42Z15/2T | 75 | 5700K | 45 | 50 | 55 |
| 62-217B/QK2C-S5757R1R3B42Z15/2T | 75 | 5700K | 50 | 55 | 65 |
| 62-217B/QK2C-S5757R2R4B42Z15/2T | 75 | 5700K | 55 | 60 | 70 |
| 62-217B/QK2C-S5050R1R3B42Z15/2T | 75 | 5000K | 50 | 55 | 65 |
| 62-217B/QK2C-S4040QAR1B42Z15/2T | 75 | 4000K | 45 | 50 | 55 |

Mass Production list

| Product | CRI Min. | CCT(K) | Φ(lm) Min. | Φ(lm) Typ. | Φ(lm) Max. |
|---------------------------------|----------|--------|------------|------------|------------|
| 62-217B/KK2C-S4040QAR2B42Z15/2T | 80 | 4000K | 45 | 50 | 60 |
| 62-217B/KK2C-S3030PBQAB42Z15/2T | 80 | 3000K | 40 | 45 | 50 |
| 62-217B/KK2C-S3030QAR2B42Z15/2T | 80 | 3000K | 45 | 50 | 60 |
| 62-217B/KK2C-S2727PAQAB42Z15/2T | 80 | 2700K | 36 | 40 | 50 |

Notes:
 Tolerance of Luminous flux: ±11%.

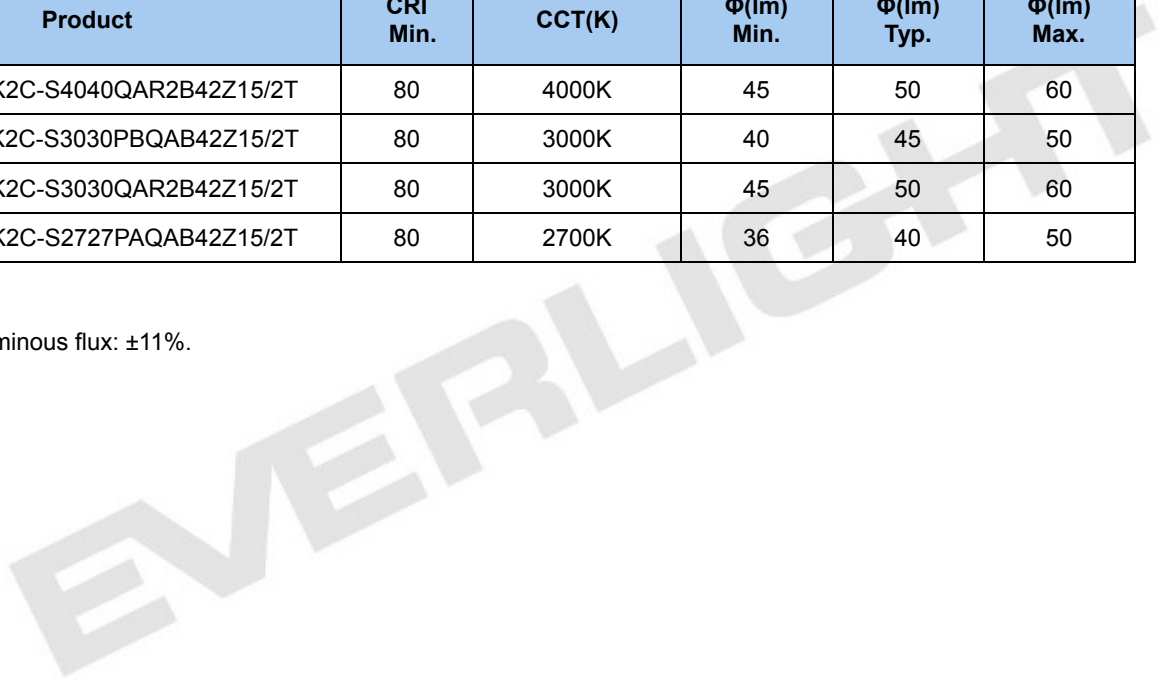

Device Selection Guide

| Chip Materials | Emitted Color | Resin Color |
|----------------|---|-------------|
| InGaN | Cool White Neutral White Warm White | Water Clear |

Absolute Maximum Ratings (T_{Soldering}=25)

| Parameter | Symbol | Rating | Unit |
|---|---------------------|--|---------------------------|
| Forward Current | I _F | 180 | mA |
| Peak Forward Current (Duty 1/10 @10ms) | I _{FP} | 300 | mA |
| Power Dissipation | P _d | 670 | mW |
| Electrostatic Discharge(HBM) | ESD | 2000 | V |
| Operating Temperature | T _{opr} | -40 ~ +85 | |
| Storage Temperature | T _{stg} | -40 ~ +100 | |
| Thermal Resistance (Junction / Soldering point) | R _{th J-S} | 26 | /W |
| Junction Temperature | T _j | 115 | |
| Soldering Temperature | T _{sol} | Reflow Soldering : 260 Hand Soldering : 350 | for 10 sec. for 3 sec. |

Electro-Optical Characteristics (T_{Soldering}=25)

| Parameter | Symbol | Min. | Typ. | Max. | Unit | Condition |
|-----------------|-------------------|-------|-------|-------|------|-----------------------|
| Luminous Flux | Φ | 36 | ----- | 70 | lm | I _F =150mA |
| Forward Voltage | V _F | 2.8 | ----- | 3.5 | V | I _F =150mA |
| Viewing Angle | 2θ _{1/2} | ----- | 120 | ----- | deg | I _F =150mA |

Notes:

1. Tolerance of Luminous flux: ±11%.
2. Tolerance of Forward Voltage : ±0.1V.

Bin Range of Luminous Flux

| Bin Code | Min. | Max. | Unit | Condition |
|----------|------|------|------|-----------------------|
| PA | 36 | 40 | lm | I _F =150mA |
| PB | 40 | 45 | | |
| QA | 45 | 50 | | |
| R1 | 50 | 55 | | |
| R2 | 55 | 60 | | |
| R3 | 60 | 65 | | |
| R4 | 65 | 70 | | |

Notes:
 Tolerance of Luminous flux: ±11%

Bin Range of Forward Voltage

| Group | Bin Code | Min. | Max. | Unit | Condition |
|-------|----------|------|------|------|-----------------------|
| B42 | 35 | 2.8 | 2.9 | V | I _F =150mA |
| | 36 | 2.9 | 3.0 | | |
| | 37 | 3.0 | 3.1 | | |
| | 38 | 3.1 | 3.2 | | |
| | 39 | 3.2 | 3.3 | | |
| | 40 | 3.3 | 3.4 | | |
| | 41 | 3.4 | 3.5 | | |

Notes:
 Tolerance of Forward Voltage : ±0.1V.

Electro-Optical Characteristics

Warm White

| If (mA) | Vf(V) | Power(W) | Flux(lm) | Lm/W |
|---------|-------|----------|----------|-------|
| 50 | 2.80 | 0.14 | 18.3 | 130.7 |
| 100 | 2.93 | 0.29 | 32.6 | 112.4 |
| 120 | 3.06 | 0.37 | 40.1 | 109.2 |
| 150 | 3.13 | 0.47 | 47.9 | 102.0 |
| 180 | 3.20 | 0.58 | 54.9 | 95.3 |

Cool White

| If (mA) | Vf(V) | Power(W) | Flux(lm) | Lm/W |
|---------|-------|----------|----------|-------|
| 50 | 2.79 | 0.14 | 20.2 | 144.3 |
| 100 | 2.96 | 0.29 | 35.3 | 121.7 |
| 120 | 3.08 | 0.37 | 42.8 | 115.6 |
| 150 | 3.11 | 0.47 | 51.3 | 109.2 |
| 180 | 3.23 | 0.58 | 59.5 | 102.6 |

Notes:
Data is only for reference..

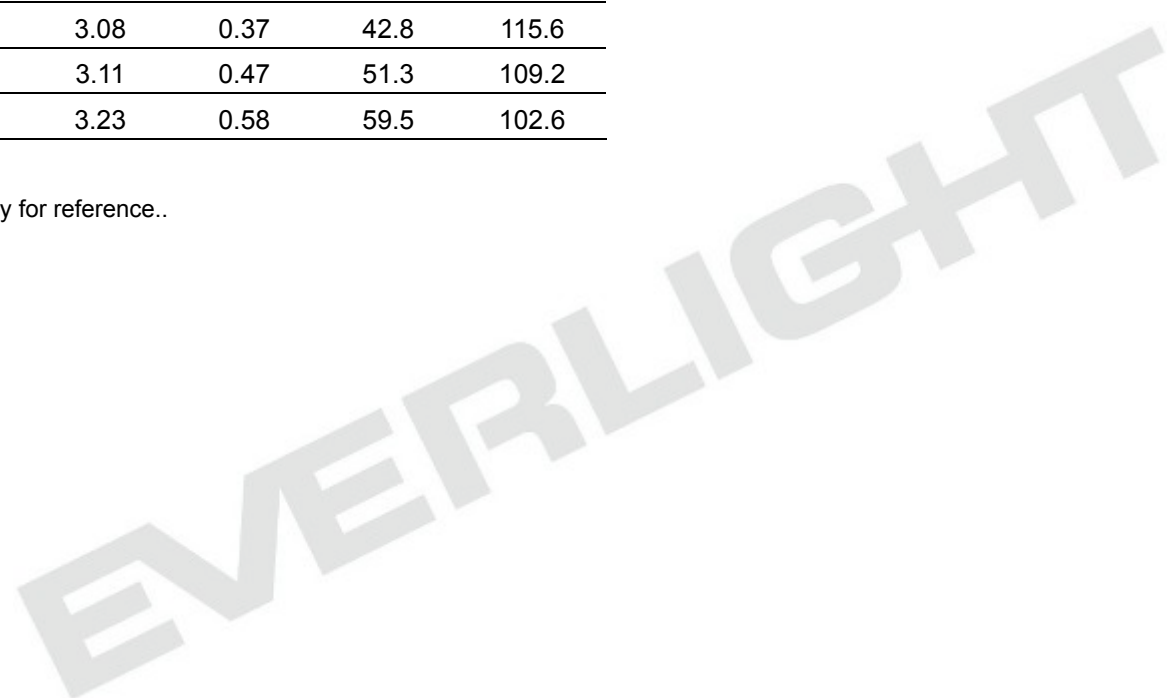

Bin Range of Chromaticity Coordinate

| CCT | Bin Code | CIE_x | CIE_y | Bin Code | CIE_x | CIE_y |
|-------|----------|--------|--------|----------|--------|--------|
| 5700K | 57K-1 | 0.3376 | 0.3616 | 57K-3 | 0.3293 | 0.3423 |
| | | 0.3292 | 0.3539 | | 0.3215 | 0.3353 |
| | | 0.3293 | 0.3423 | | 0.3222 | 0.3243 |
| | | 0.3371 | 0.3493 | | 0.3294 | 0.3306 |
| | 57K-2 | 0.3292 | 0.3539 | 57K-4 | 0.3371 | 0.3493 |
| | | 0.3207 | 0.3462 | | 0.3293 | 0.3423 |
| | | 0.3215 | 0.3353 | | 0.3294 | 0.3306 |
| | | 0.3293 | 0.3423 | | 0.3366 | 0.3369 |
| 4000K | 40K-1 | 0.4006 | 0.4044 | 40K-3 | 0.3828 | 0.3803 |
| | | 0.3871 | 0.3959 | | 0.3703 | 0.3726 |
| | | 0.3828 | 0.3803 | | 0.3670 | 0.3578 |
| | | 0.3952 | 0.3880 | | 0.3784 | 0.3647 |
| | 40K-2 | 0.3871 | 0.3959 | 40K-4 | 0.3952 | 0.3880 |
| | | 0.3736 | 0.3874 | | 0.3828 | 0.3803 |
| | | 0.3703 | 0.3726 | | 0.3784 | 0.3647 |
| | | 0.3828 | 0.3803 | | 0.3898 | 0.3716 |
| 3000K | 30K-1 | 0.4562 | 0.4260 | 30K-3 | 0.4345 | 0.4033 |
| | | 0.4431 | 0.4213 | | 0.4223 | 0.3990 |
| | | 0.4345 | 0.4033 | | 0.4147 | 0.3814 |
| | | 0.4468 | 0.4077 | | 0.4260 | 0.3854 |
| | 30K-2 | 0.4431 | 0.4213 | 30K-4 | 0.4468 | 0.4077 |
| | | 0.4299 | 0.4165 | | 0.4345 | 0.4033 |
| | | 0.4223 | 0.3990 | | 0.4260 | 0.3854 |
| | | 0.4345 | 0.4033 | | 0.4373 | 0.3893 |
| 2700K | 27K-1 | 0.4813 | 0.4319 | 27K-3 | 0.4585 | 0.4104 |
| | | 0.4688 | 0.4290 | | 0.4468 | 0.4077 |
| | | 0.4585 | 0.4104 | | 0.4373 | 0.3893 |
| | | 0.4703 | 0.4132 | | 0.4483 | 0.3919 |
| | 27K-2 | 0.4688 | 0.4290 | 27K-4 | 0.4703 | 0.4132 |
| | | 0.4562 | 0.4260 | | 0.4585 | 0.4104 |
| | | 0.4468 | 0.4077 | | 0.4483 | 0.3919 |
| | | 0.4585 | 0.4104 | | 0.4593 | 0.3944 |

Notes:

1. The value are based on driving current by 150mA.
2. Tolerance of Chromaticity Coordinates : ±0.01.

The C.I.E. 1931 Chromaticity Diagram

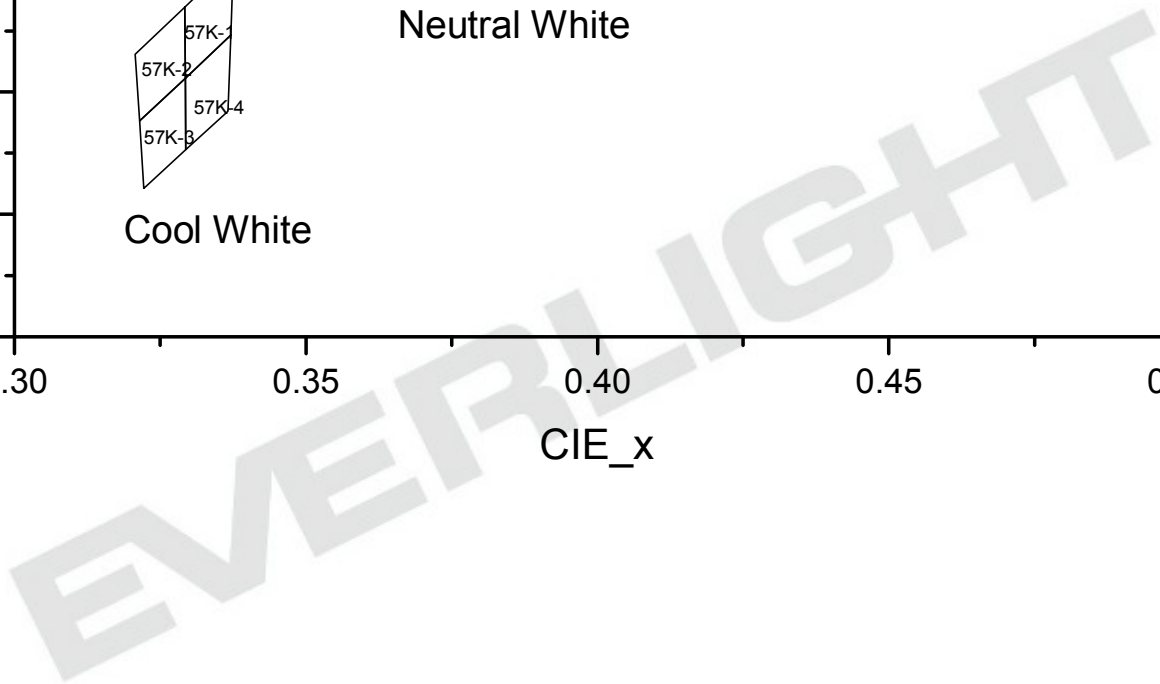
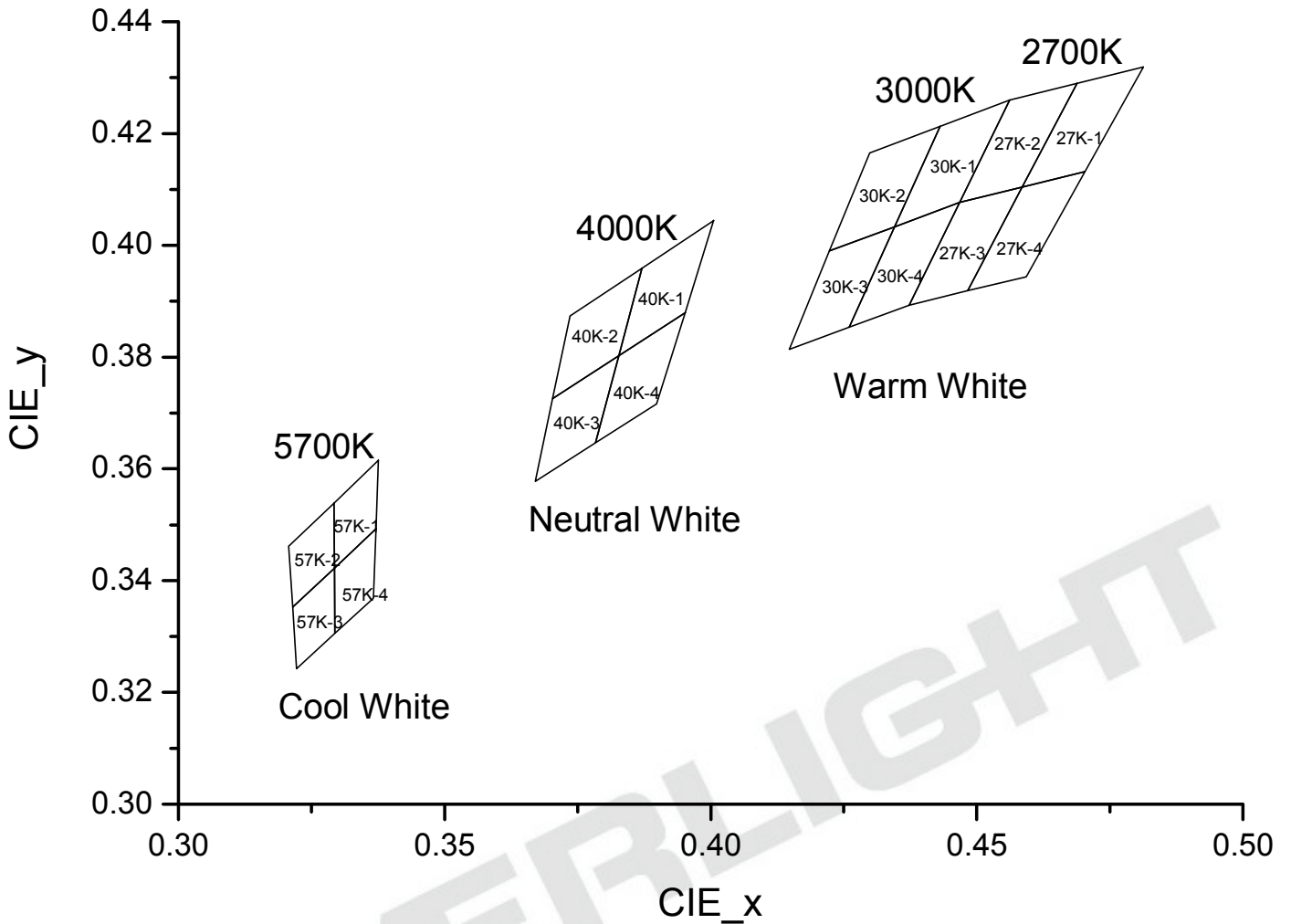

Spectrum Distribution

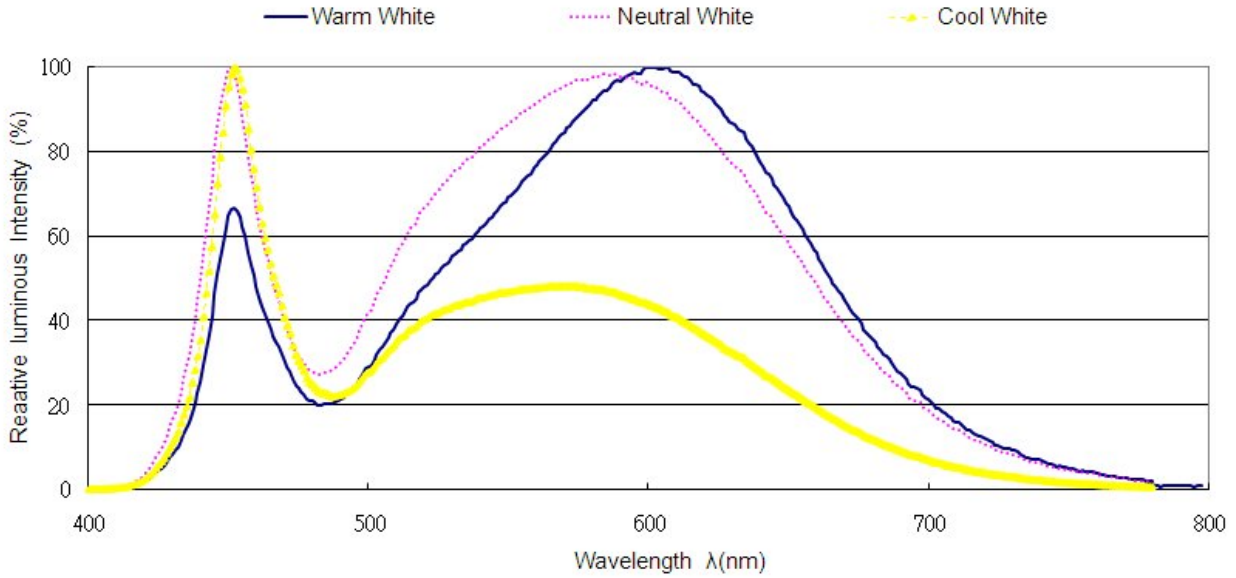

Typical Electro-Optical Characteristics Curves

Fig.1 – Forward Voltage Shift vs. Junction Temperature

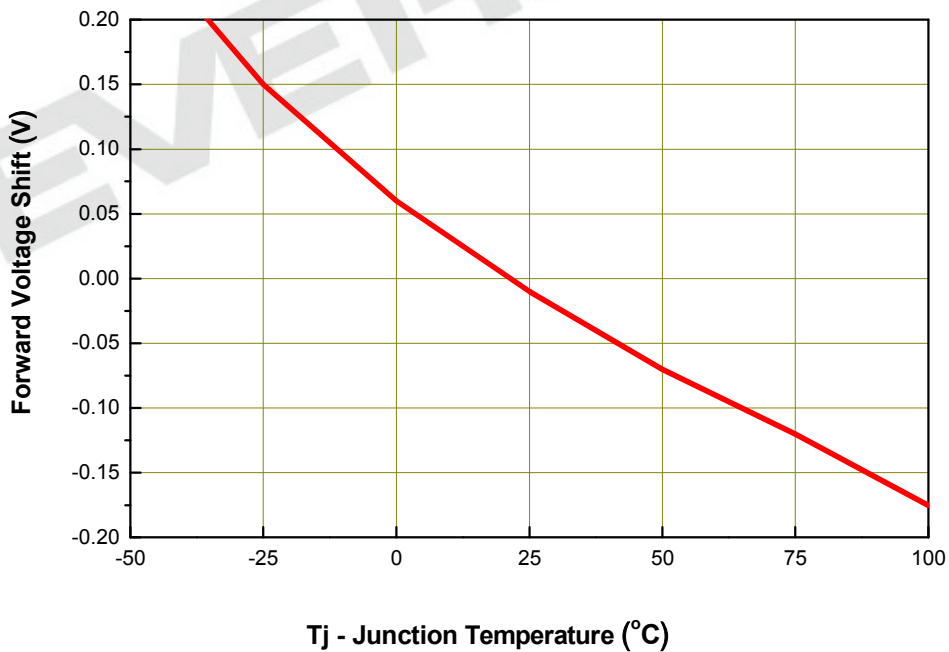

Fig.2 - Relative Luminous Intensity vs. Forward Current

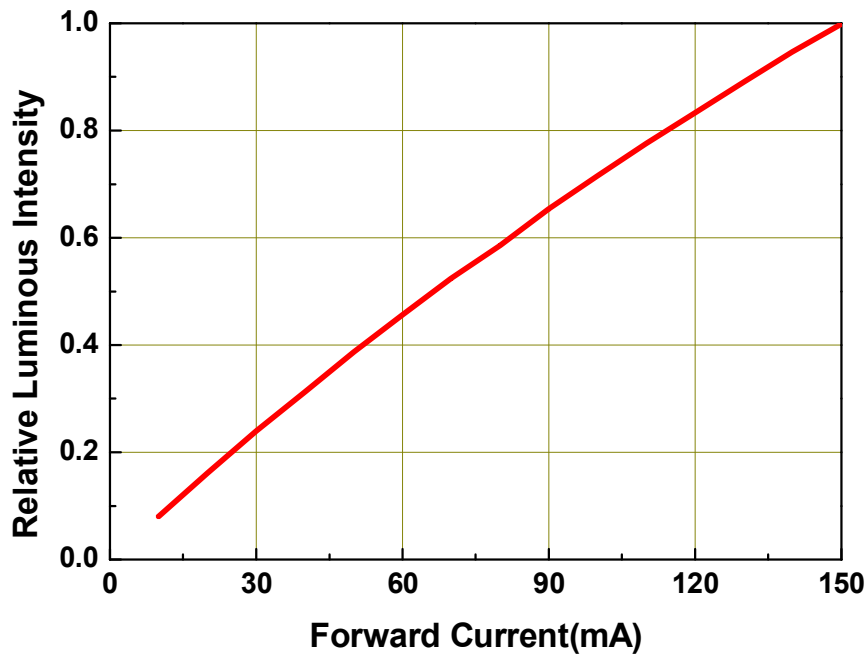

Fig.3 - Relative Luminous Intensity vs. Junction Temperature

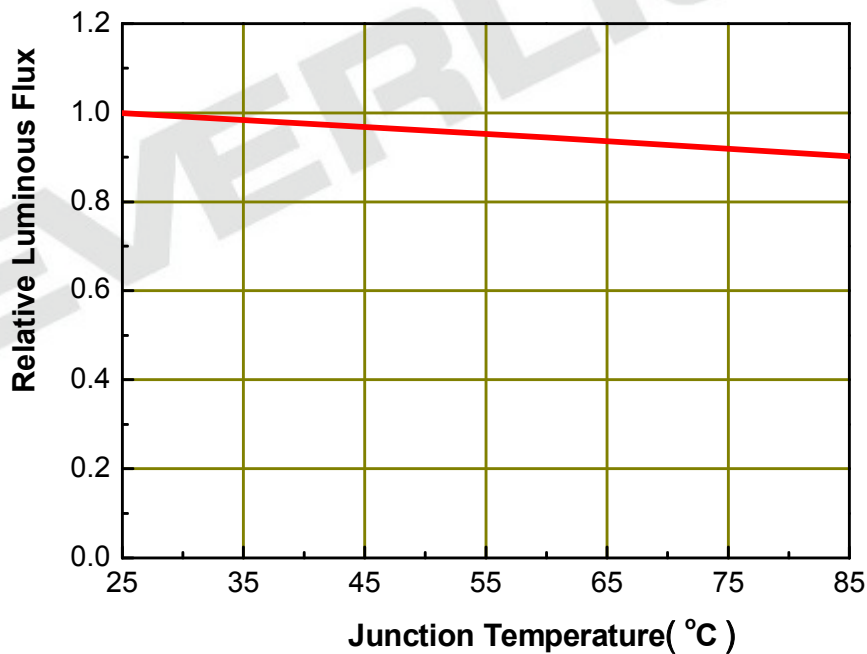

Fig.4 - Forward Current vs.
Forward Voltage

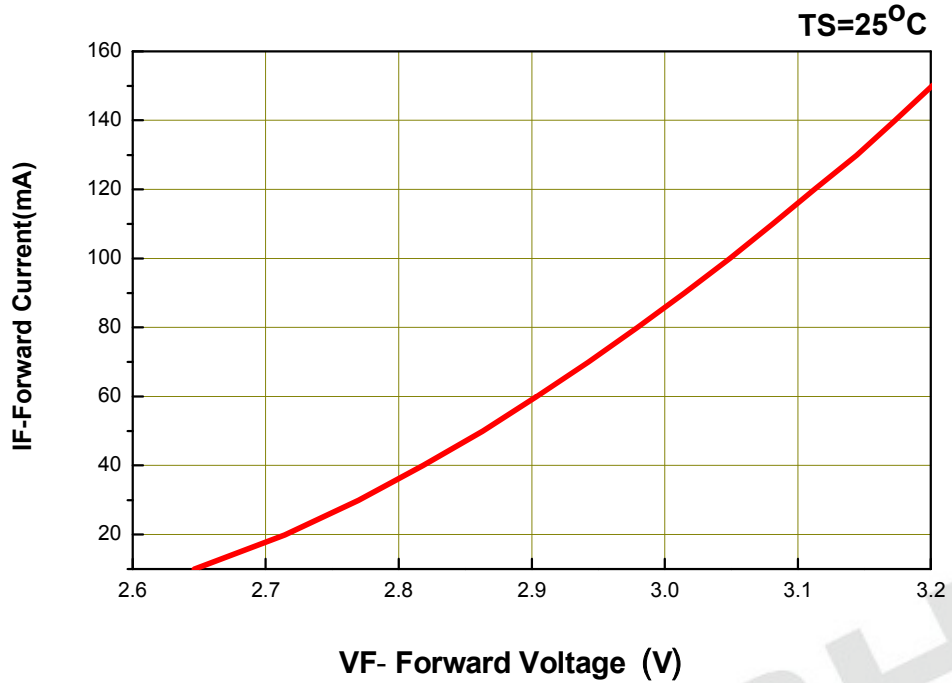

Fig.5 – Max. Driving Forward Current
vs. Soldering Temperature

Rth j-s=26° C/W

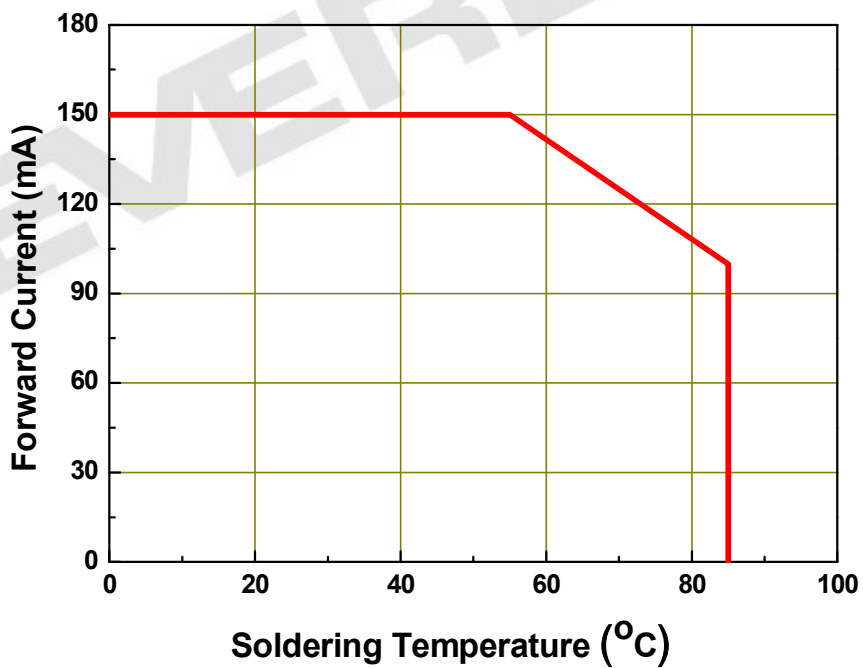
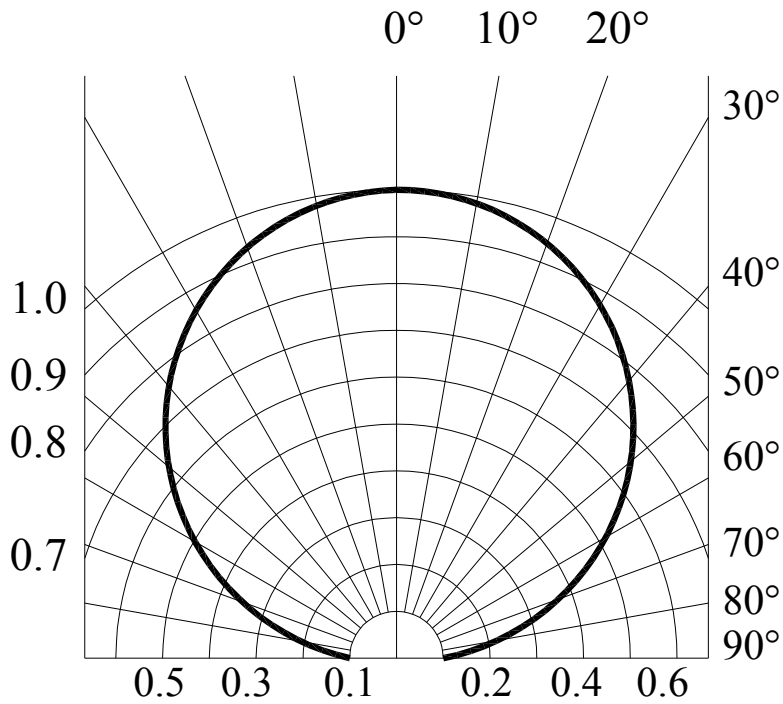
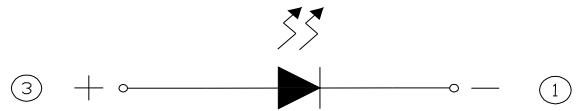
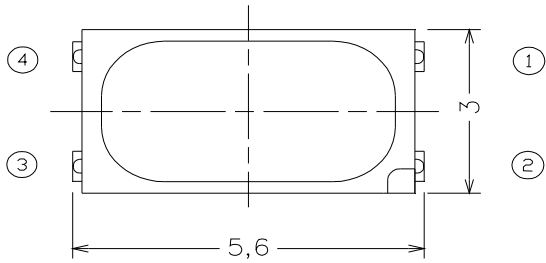

Fig.6 - Radiation Diagram



EVERLIGHT

Package Dimension



Polarity

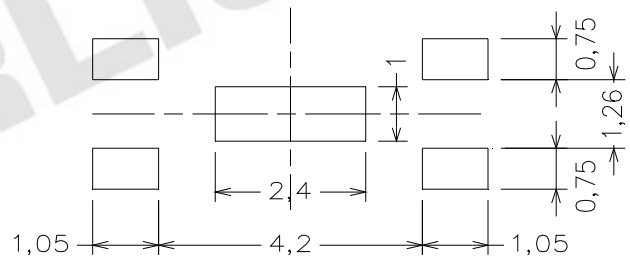
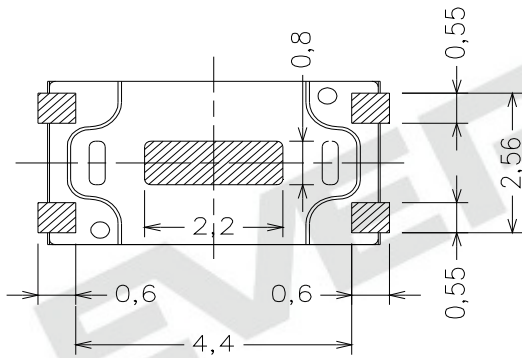
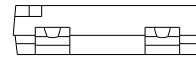
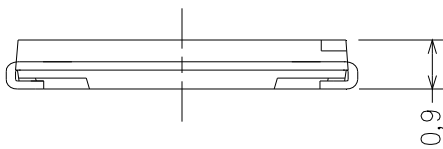

Note:
 Tolerance unless mentioned is $\pm 0.2\text{mm}$; Unit = mm

Moisture Resistant Packing Materials

Label Explanation



- CPN: Customer's Product Number
- P/N: Product Number
- QTY: Packing Quantity
- CAT: Luminous Intensity Rank
- HUE: Dom. Wavelength Rank
- REF: Forward Voltage Rank
- LOT No: Lot Number

Reel Dimensions

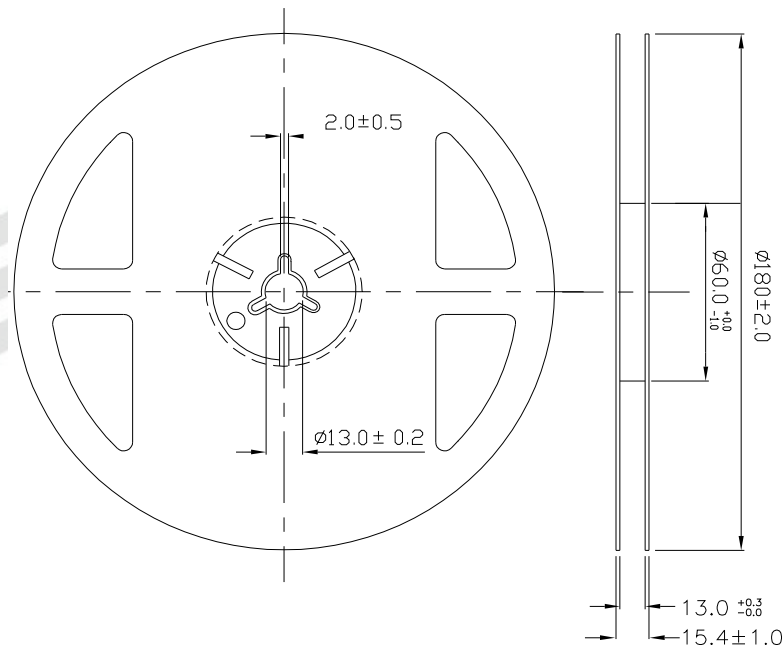

Note:
 Tolerances unless mentioned ± 0.1 mm. Unit = mm

Carrier Tape Dimensions: Loaded Quantity 2000 pcs Per Reel

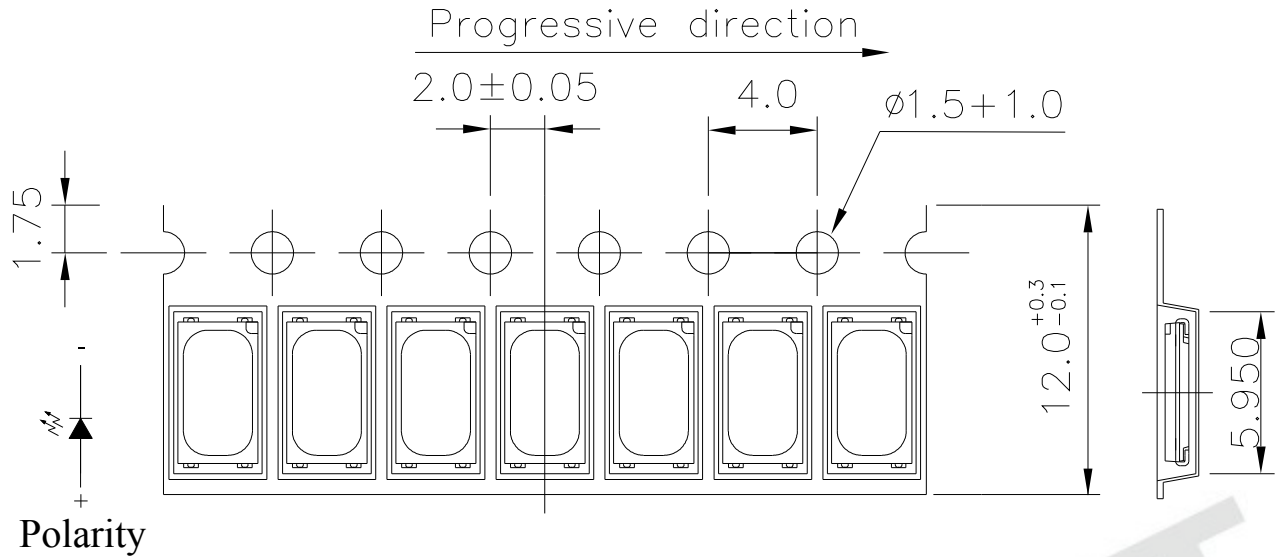

Note:
 Tolerances unless mentioned ± 0.1 mm. Unit = mm

Moisture Resistant Packing Process

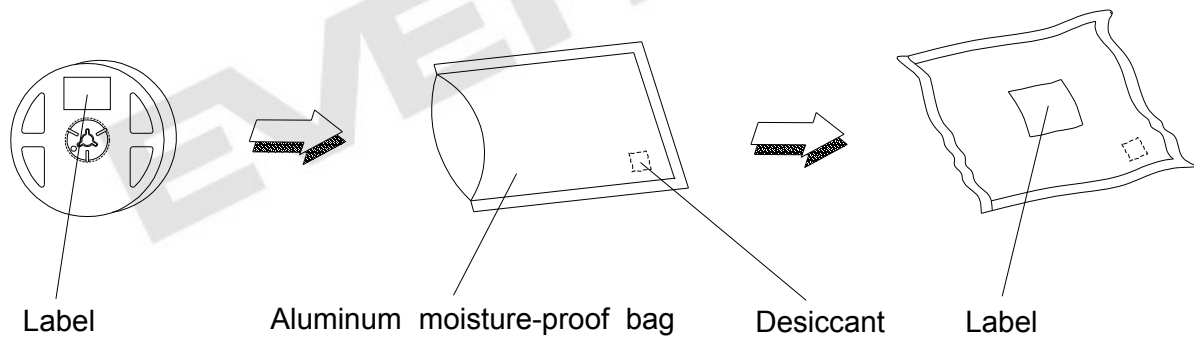

Reliability Test Items and Conditions

The reliability of products shall be satisfied with items listed below.

Confidence level : 90%

LTPD : 10%

| No. | Items | Test Condition | Test Hours/Cycles | Sample Size | Ac/Re |
|-----|-------------------------------------|--|-------------------|-------------|-------|
| 1 | Reflow Soldering | Temp. : 260 /10sec. | 6 Min. | 22 PCS. | 0/1 |
| 2 | Thermal Shock | H : +100 5min 10 sec L : -10 5min | 200 Cycles | 22 PCS. | 0/1 |
| 3 | Temperature Cycle | H : +100 15min 5 min L : -40 15min | 200 Cycles | 22 PCS. | 0/1 |
| 4 | High Temperature/Humidity Storage | Ta=85 ,85%RH | 1000 Hrs. | 22 PCS. | 0/1 |
| 5 | High Temperature/Humidity Operation | Ta=85 ,85%RH, I _F = 100 mA | 1000 Hrs. | 22 PCS. | 0/1 |
| 6 | Low Temperature Storage | Ta=-40 | 1000 Hrs. | 22 PCS. | 0/1 |
| 7 | High Temperature Storage | Ta=85 | 1000 Hrs. | 22 PCS. | 0/1 |
| 8 | Low Temperature Operation Life | Ta=-40 , I _F = 180 mA | 1000 Hrs. | 22 PCS. | 0/1 |
| 9 | High Temperature Operation/ Life#1 | Ta=25 , I _F = 180 mA | 1000 Hrs. | 22 PCS. | 0/1 |
| 10 | High Temperature Operation/ Life#2 | Ta=55 , I _F =180 mA | 1000 Hrs. | 22 PCS. | 0/1 |
| 11 | High Temperature Operation/ Life#3 | Ta=85 , I _F = 100 mA | 1000 Hrs. | 22 PCS. | 0/1 |

Precautions for Use

1. Over-current-proof

Customer must apply resistors for protection; otherwise slight voltage shift will cause big current change (Burn out will happen).

2. Storage

2.1 Do not open moisture proof bag before the products are ready to use.

2.2 Before opening the package: The LEDs should be kept at 30 °C or less and 90%RH or less.

2.3 After opening the package: The LED's floor life is 72 Hrs under 30 °C or less and 60% RH or less. If unused LEDs remain, it should be stored in moisture proof packages.

2.4 If the moisture absorbent material (silica gel) has faded away or the LEDs have exceeded the storage time, baking treatment should be performed using the following conditions.

Baking treatment: 60±5 °C for 24 hours.

3. Soldering Condition

3.1 Pb-free solder temperature profile

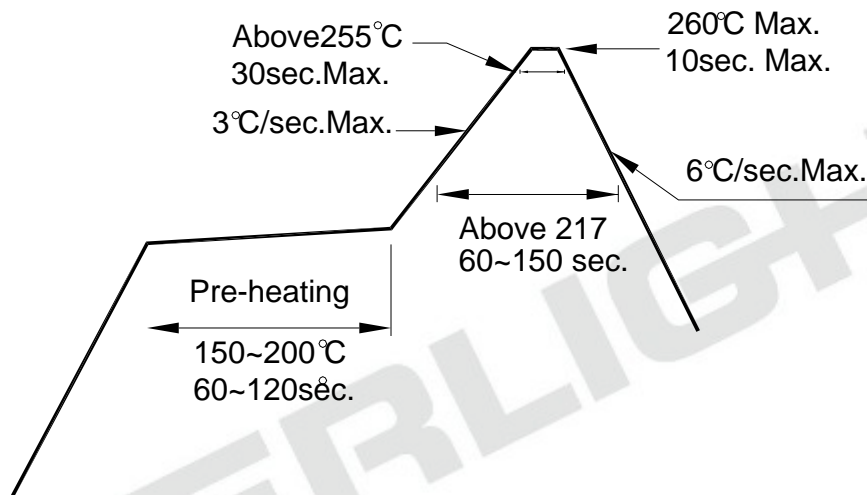

3.2 Reflow soldering should not be done more than two times.

3.3 When soldering, do not put stress on the LEDs during heating.

3.4 After soldering, do not warp the circuit board.

4. Soldering Iron

Each terminal is to go to the tip of soldering iron temperature less than 350 for 3 seconds within once in less than the soldering iron capacity 25W. Leave two seconds and more intervals, and do soldering of each terminal. Be careful because the damage of the product is often started at the time of the hand solder.

5. Repairing

Repair should not be done after the LEDs have been soldered. When repairing is unavoidable, a double-head soldering iron should be used (as below figure). It should be confirmed beforehand whether the characteristics of the LEDs will or will not be damaged by repairing.

