

VOLTAGE RANGE: 400 - 600V
CURRENT: 1.0 A

Features

- Low forward voltage drop
- High current capability
- Easily cleaned with Freon, Alcohol, Isopropanol and similar solvents
- The plastic material carries U/L recognition 94V-0

Mechanical Data

- Case : DO-15 Molded plastic
- Epoxy : UL94V-0 rate flame retardant
- Lead : Axial lead solderable per MIL-STD-202, Method 208 guaranteed
- Polarity : Color band denotes cathode end
- Mounting position : Any
- Weight : 0.465 gram

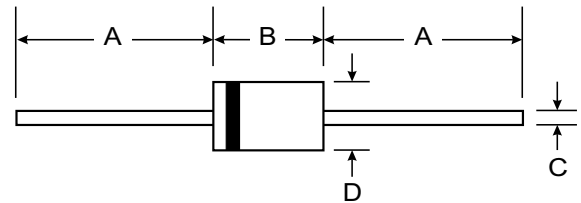
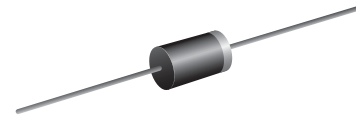

DO-15		
Dim	Min	Max
A	25.40	—
B	5.50	7.62
C	0.686	0.889
D	2.60	3.60
All Dimensions in mm		

Maximum Ratings and Electrical Characteristics T_A = 25°C unless otherwise specified

Single phase, half wave, 60Hz, resistive or inductive load. For capacitive load, derate current by 20%.

Characteristic	Symbol	1S1834	1S1835	Unit
Maximum recurrent peak reverse voltage	V_{RRM}	400	600	V
Maximum RMS voltage	V_{RMS}	280	420	V
Maximum DC blocking voltage	V_{DC}	400	600	V
Maximum average forward rectified current 9.5mm lead length, @T _A =75°C	$I_{F(AV)}$	1.0		A
Peak forward surge current 8.3ms single half-sine-wave superimposed on rated load @T _J =125°C	I_{FSM}	60.0		A
Maximum instantaneous forward voltage @ 1.5 A	V_F	1.2		V
Maximum reverse current @T _A =25°C at rated DC blocking voltage @T _A =100°C	I_R	10.0	100.0	μA
Maximum reverse recovery time (Note1)	t_{rr}	350		ns
Typical junction capacitance (Note2)	C_J	12		pF
Typical thermal resistance (Note3)	$R_{\theta JA}$	55		°C/W
Operating junction temperature range	T_J	-55-----+150		°C
Storage temperature range	T_{STG}	-55-----+150		°C

NOTE: 1. Measured with $I_F=0.5A$, $I_R=1A$, $t_{rr}=0.25A$.

2. Measured at 1.0MHz and applied reverse voltage of 4.0V DC.

3. Thermal resistance from junction to ambient.



FIG.1 – REVERSE RECOVERY TIME CHARACTERISTIC AND TEST CIRCUIT DIAGRAM

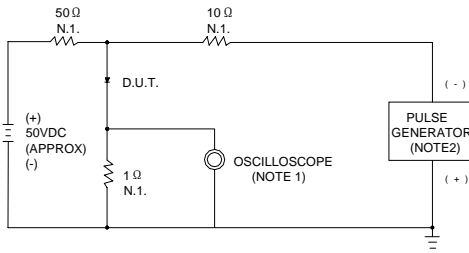

NOTES: 1. RISE TIME = 7ns MAX. INPUT IMPEDANCE = 1MΩ, 22pF
 2. RISE TIME = 10ns MAX. SOURCE IMPEDANCE = 50Ω

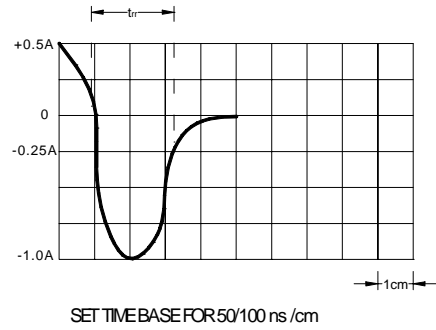

FIG.2 – TYPICAL FORWARD CHARACTERISTIC

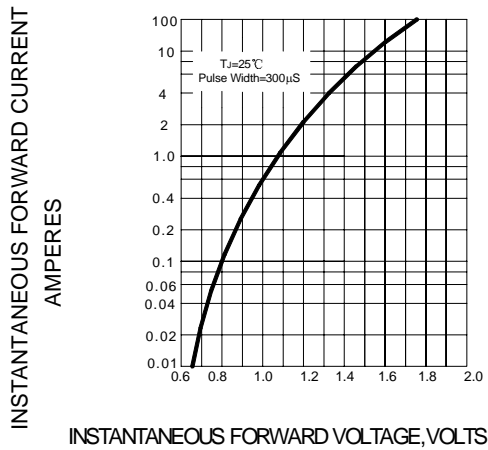

FIG.3 – FORWARD DERATING CURVE

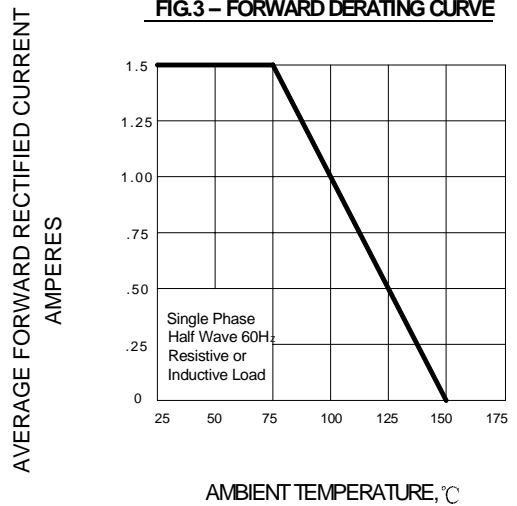

FIG.5 – PEAK FORWARD SURGE CURRENT

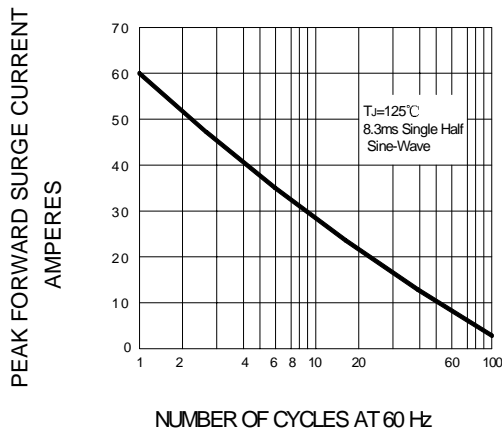

FIG.6 – TYPICAL JUNCTION CAPACITANCE

