

VOLTAGE RANGE: 50V-1000 V
CURRENT: 3.0 A

Features

- Glass Passivated Die Construction
- Fast Recovery Time for High Efficiency
- Low Forward Voltage Drop and High Current Capability
- Ideally Suited for Automatic Assembly
- Plastic Material: UL Flammability Classification Rating 94V-0

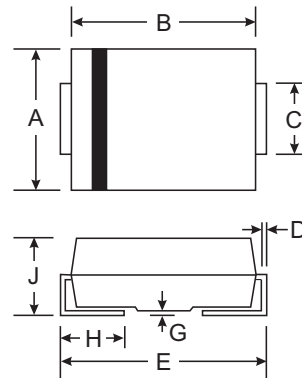
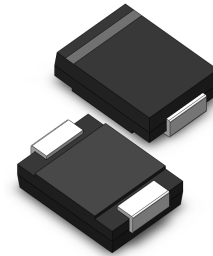

SMC/DO-214AB		
Dim	Min	Max
A	5.59	6.22
B	6.60	7.11
C	2.75	3.18
D	0.15	0.31
E	7.75	8.13
G	0.10	0.20
H	0.76	1.52
J	2.00	2.62
All Dimensions in mm		

Mechanical Data

- Case: SMC/DO-214AB, Molded Plastic
- Terminals: Solder Plated, Solderable per MIL-STD-750, Method 2026
- Polarity: Cathode Band or Cathode Notch
- Marking: Type Number
- Weight: 0.21 grams (approx.)



Maximum Ratings and Electrical Characteristics T_A = 25°C unless otherwise specified

Single phase, half wave, 60Hz, resistive or inductive load. For capacitive load, derate current by 20%.

Characteristic	Symbol	SMF301C	SMF302C	SMF303C	SMF304C	SMF305C	SMF306C	SMF307C	Unit
Peak Repetitive Reverse Voltage Working Peak Reverse Voltage DC Blocking Voltage	V _{RRM} V _{RWM} V _R	50	100	200	400	600	800	1000	V
RMS Reverse Voltage	V _{R(RMS)}	35	70	140	280	420	560	700	V
Average Rectified Output Current @ T _T = 75°C	I _O	3.0							A
Non-Repetitive Peak Forward Surge Current 8.3ms Single half sine-wave Superimposed on Rated Load (JEDEC Method)	I _{FSM}	100							A
Forward Voltage @ I _F = 3.0A	V _{FM}	1.3							V
Peak Reverse Current @ T _A = 25°C at Rated DC Blocking Voltage @ T _A = 125°C	I _{RM}	5.0 250							μA
Maximum Recovery Time (Note 3)	t _{rr}	150				250	500		ns
Typical Junction Capacitance (Note 2)	C _j	50							pF
Typical Thermal Resistance Junction to Terminal (Note 1)	R _{θJT}	25							K/W
Operating and Storage Temperature Range	T _j , T _{STG}	-65 to +150							°C

- Notes:
1. Thermal resistance: junction to terminal, unit mounted on PC board with 5.0 mm² (0.013 mm thick) copper pad as heat sink.
 2. Measured at 1.0MHz and applied reverse voltage of 4.0V DC.
 3. Reverse recovery test conditions: I_F = 0.5A, I_R = 1.0A, I_{rr} = 0.25A. See figure 5.

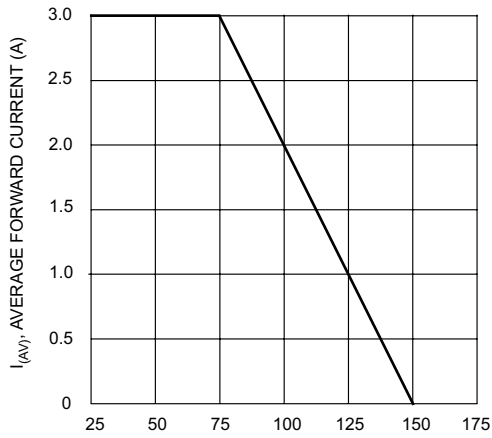

T_T , TERMINAL TEMPERATURE (°C)
Fig. 1 Forward Current Derating Curve

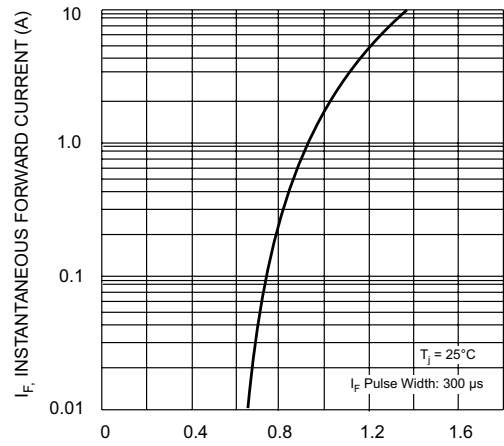

V_F , INSTANTANEOUS FORWARD VOLTAGE (V)
Fig. 2 Typical Forward Characteristics

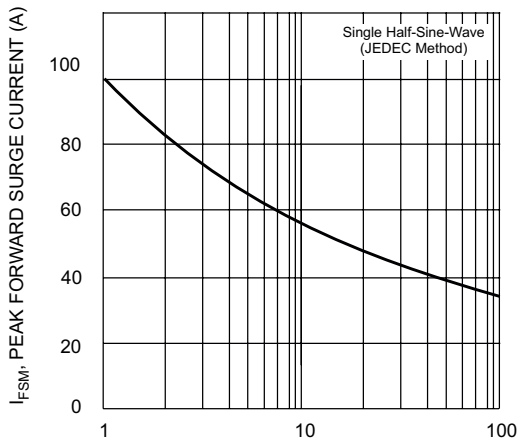

Fig. 3 Forward Surge Current Derating Curve

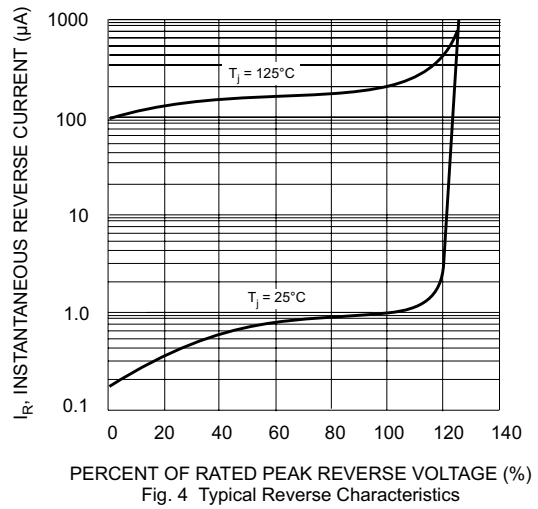
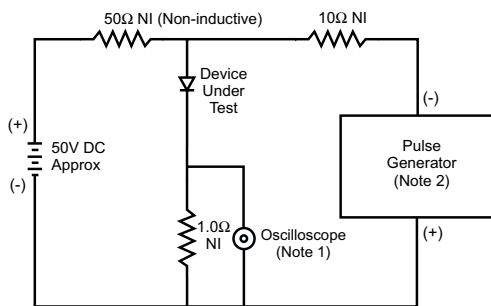
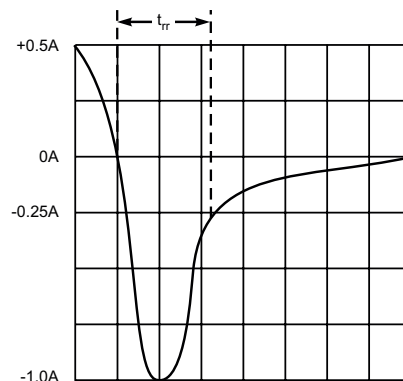

Fig. 4 Typical Reverse Characteristics



- Notes:
 1. Rise Time = 7.0ns max. Input Impedance = 1.0M Ω , 22pF.
 2. Rise Time = 10ns max. Input Impedance = 50 Ω .



Set time base for 50/100 ns/cm

Fig. 5 Reverse Recovery Time Characteristic and Test Circuit