

VOLTAGE RANGE: 50 - 1000V

CURRENT: 1.0 A

Features

- Glass Passivated Die Construction
- Ideally Suited for Automatic Assembly
- Low Forward Voltage Drop, High Efficiency
- Low Power Loss
- Fast Recovery Time
- Plastic Case Material has UL Flammability

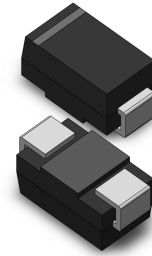

Mechanical Data

- Case: SMA/DO-214AC, Molded Plastic
- Terminals: Solder Plated, Solderable per MIL-STD-750, Method 2026
- Polarity: Cathode Band or Cathode Notch
- Marking: Type Number
- Weight: 0.064 grams (approx.)

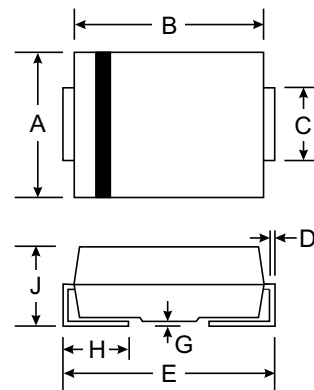

SMA(DO-214AC)		
Dim	Min	Max
A	2.29	2.92
B	4.00	4.60
C	1.27	1.63
D	0.15	0.31
E	4.80	5.59
G	0.10	0.20
H	0.76	1.52
J	2.01	2.62
All Dimensions in mm		

Maximum Ratings and Electrical Characteristics T_A = 25°C unless otherwise specified

Single phase, half wave, 60Hz, resistive or inductive load. For capacitive load, derate current by 20%.

Characteristic	Symbol	SMF101A	SMF102A	SMF103A	SMF104A	SMF105A	SMF106A	SMF107A	Unit
Maximum repetitive peak reverse voltage	V _{RRM}	50	100	200	400	600	800	1000	V
Maximum RMS voltage	V _{RMS}	35	70	140	280	420	560	700	V
Maximum DC blocking voltage	V _{DC}	50	100	200	400	600	800	1000	V
Maximum average forward rectified current at T _A =65°C (NOTE 1)	I _(AV)	1.0							A
Peak forward surge current 8.3ms single half sine-wave superimposed on rated load (JEDEC Method) T _L =25°C	I _{FSM}	30.0							A
Maximum instantaneous forward voltage at 1.0A	V _F	1.3							V
Maximum DC reverse current T _A =25°C at rated DC blocking voltage T _A =100°C	I _R	5.0 100.0							μA
Maximum reverse recovery time (NOTE 2)	t _{rr}	150				250	500		ns
Typical junction capacitance (NOTE 3)	C _J	15							pF
Typical thermal resistance (NOTE 4)	R _{θJA}	180							K/W
Operating junction and storage temperature range	T _J , T _{STG}	-50 to +150							°C

- Note:**
1. Averaged over any 20ms period.
 2. Measured with I_F=0.5A, I_R=1A, I_{rr}=0.25A.
 3. Measured at 1MHz and applied reverse voltage of 4.0V D.C.
 4. Thermal resistance junction to ambient, 6.0 mm² copper pads to each terminal.

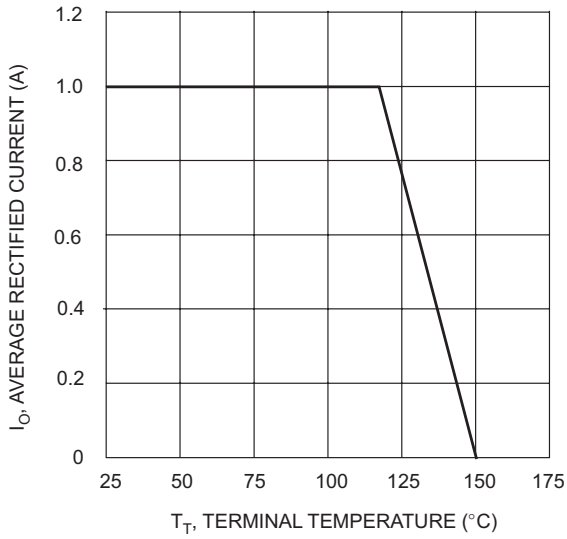

Fig. 1 Forward Current Derating Curve

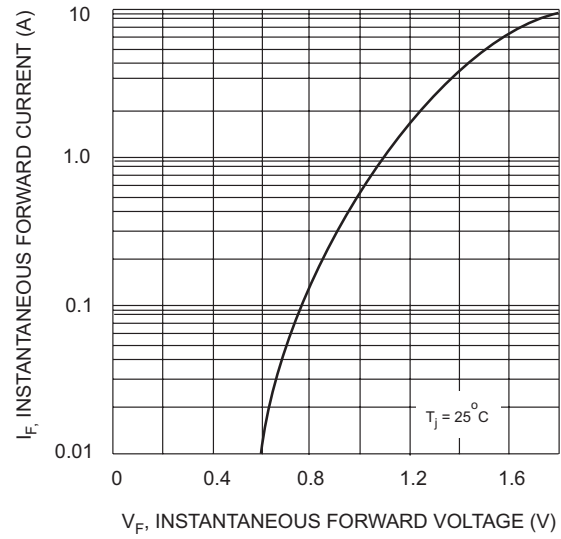

Fig. 2 Typical Forward Characteristics

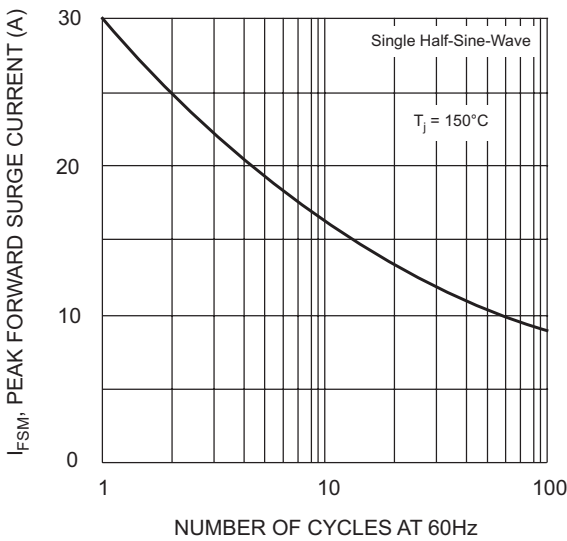

Fig. 3 Forward Surge Current Derating Curve

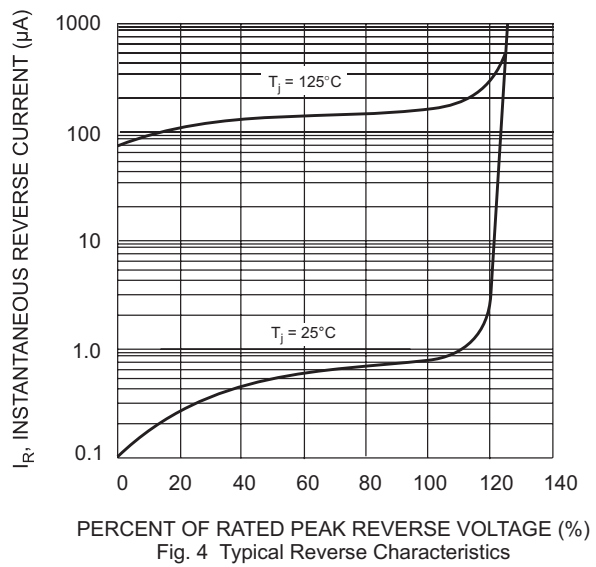
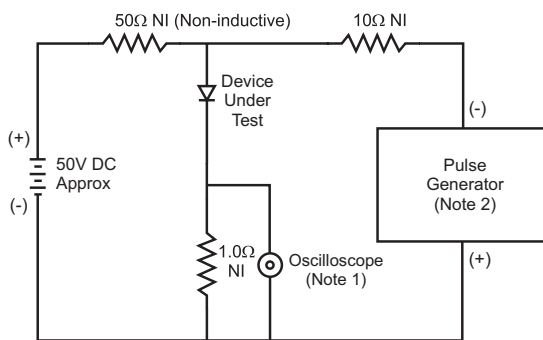

Fig. 4 Typical Reverse Characteristics



Notes:
 1. Rise Time = 7.0ns max. Input Impedance = 1.0M Ω , 22pF.
 2. Rise Time = 10ns max. Input Impedance = 50 Ω .

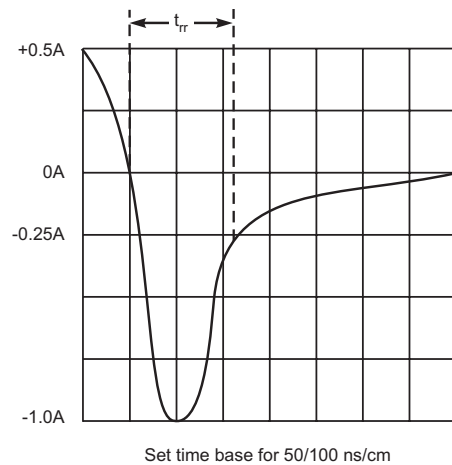

Fig. 5 Reverse Recovery Time Characteristic and Test Circuit