









# 32.768kHz Series Tuning Fork Crystal Units

The 32.768kHz tuning fork crystal unit is the most widely used frequency control product. TAITIEN's tuning-fork-type crystals have low power consumption ideal for portable application. Their different package sizes provide the customers more choices for time management. TAITIEN's tuning-fork-type crystals are cost effective real time clock products.

Type	XA	XB		XD			XN	
Size (mm)	3 x 8	1 x 4	2 x 6	2.0 x 1.2	3.2 x 1.5	4.1 x 1.5	6.9 x 1.4	8.0 x 3.8
Package	DIP	DIP	DIP	SMD	SMD	SMD	SMD	SMD
RoHS	Yes	Yes	Yes	Yes	Yes	Yes	Yes*	Yes*
Outline								

\* Pb in high temperature solder (exempt per RoHS 2002/95/EC Annex (7)) and suitable for RoHS compliant reflow

## ELECTRICAL SPECIFICATION

Nominal Frequency	32.768000 kHz
Mode of Vibration	Fundamental
Storage Temp. Range (T <sub>STR</sub> )	-55°C ~+125 °C
Turnover Temperature (TM)	25±5 °C
Temperature Coefficient (β)	-(0.03±0.01) ppm/°C <sup>2</sup>
Frequency vs. Temperature (Δf / fM)	β x (T-TM) <sup>2</sup> ppm
Series Resistance (R1)	65~90 KΩ Max.
Level of Drive (DL)	0.1±0.01 uW Typ. 0.5 uW Max.
Aging (first year) (Δf / f0)	±3 ppm Max.
Quality Factor (Q)	30000~60000 Typ.
Shunt Capacitance (C0)	3~7 pF Max.
Load Capacitance (CL)	6, 7, 9, 12.5 pF (Please contact us)
Frequency Tolerance(f <sub>tol</sub> )	±20 ppm @ 25±5 °C
Insulation Resistance	500 Ω @ DC 100±15 V

Specifications subject to change without notice

## FREQ. STABILITY vs. TEMP. RANGE

Temp.( °C)	ppm	
	10~ -100	10~ -150
-20~+70	O	O
-40~+85	X	O

O: Available X: Not available

## FREQ. vs. CAPACITANCE RATIO (C0/C1)

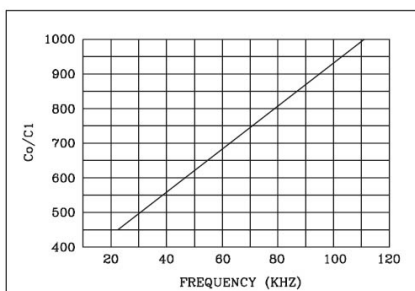

## FREQ. vs. LOAD CAPACITANCE (TYP.)

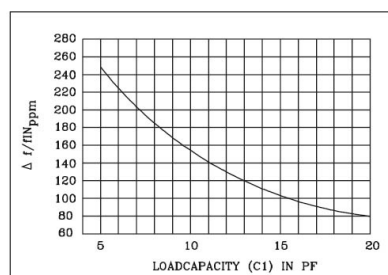

## FREQ. vs. TEMPERATURE (TYP.)

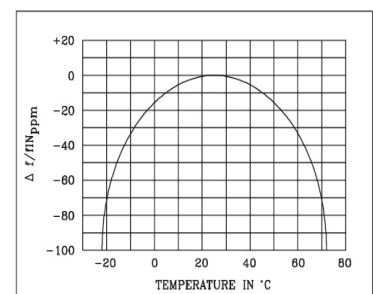

## DIMENSION (mm) – XA / XB Type

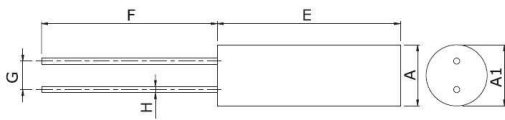

UNIT:mm

TYPE	A	A'	E	F	G	H
XA	3.0	3.1max	8.0max	10±1	0.8±0.2	∅0.32±0.07
XB-N	2.0	2.1max	6.0max	5.0min	0.7±0.2	∅0.28±0.05
XB-J	1.0	1.2max	4.6max	5.7min	0.3±0.05	∅0.18±0.03

## DIMENSION (mm) – XD Type

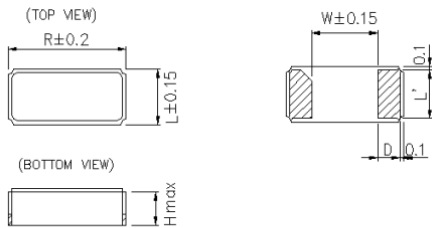

Internal connection



Model	R	L	H	W	L'	D	S	P	ΔL'
4115	4.1	1.5	0.9	2.7	1.3	0.6	3.4	1.1	1.8
3215	3.2	1.5	0.9	1.7	1.3	0.6	2.5	1.1	1.8
2012	2.0	1.2	0.6	0.8	1.0	0.5	1.4	0.6	1.1

## SOLDER PAD LAYOUT (mm)

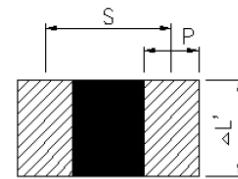

Do not design any patterns on shaded area  
 Recommended soldering pattern

## DIMENSION (mm) – XN Type

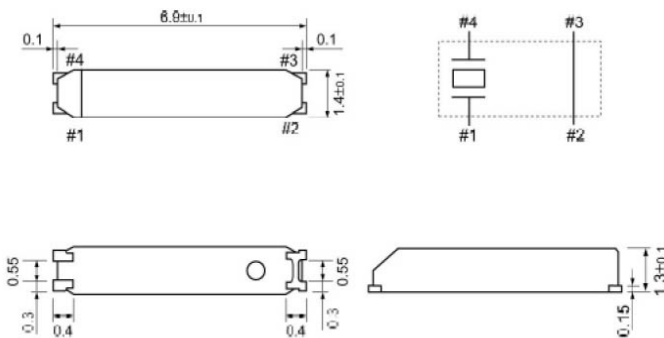

\* Do not connect to external with #2 and #3

## SOLDER PAD LAYOUT (mm)

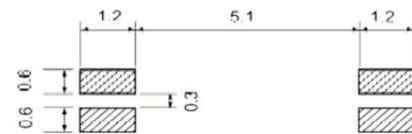

## DIMENSION (mm) – XN Type

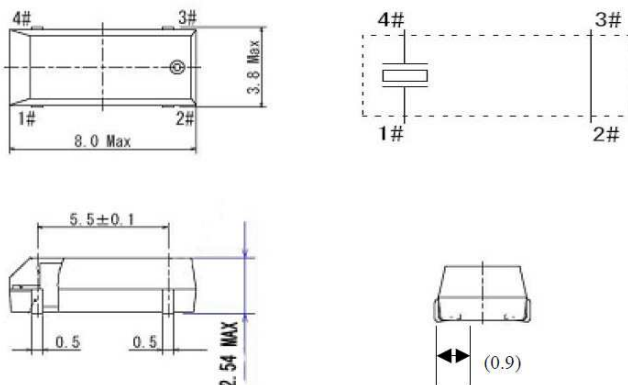

## SOLDER PAD LAYOUT (mm)

